

RESOLUCION 737 - SUBTEL

Fecha de publicación: 10/3/2026

Información Comercial

Nombre comercial del equipo

Código	Descripción
929003296801	Wi-Fi BLE Portrait Desk Lamp EU

Fabricante: Signify (China) Investment Co., Ltd.

Importador o representante en Chile: SIGNIFY CHILENA S.A.

Domicilio: El Bosque Norte 0211, Las Condes - Santiago

Correo electrónico de contacto: tomas.aragona@signify.com

Sitio Web: wizconnected.com/es-cl

Características técnicas

Tipo de equipo	Luminaria LED
Marca	WIZ
Modelo	929003296801
Módulo	ESP32-C3-MINI-1
Tecnología o modulación	DSSS, OFDM, GFSK
Frecuencias	BT: 2.400-2.483,5 ; WLAN 2,4G: 2.412-2.462 MHz.
Ganancia de antena (dBi)	3.96 dBi
P.I.R.E. (EIRP)	BT: 4,79 mW (6,80 dBm) ; WLAN 2,4G: 71,12 mW (18,52 dBm).

Declaración de conformidad

“El equipo previamente individualizado cumple con las disposiciones establecidas en la Norma Técnica de Equipos de alcance reducido, aprobada por la resolución exenta N° 1.985, de 2017, de la Subsecretaría de Telecomunicaciones.”

Firma del Importador/Responsable:

Nombre de quien firma: Tomás Aragona

Cargo: Representante Legal



- ANT.: 1) Nota ingreso Subtel N° 50.572 de 16.04.2024.
2) Resolución Exenta N° 1.985 de 2017 y sus modificaciones, de la Subsecretaría de Telecomunicaciones.
3) Resolución Exenta N° 3.103 de 2012, de la Subsecretaría de Telecomunicaciones.
4) Ley N° 18.168, General de Telecomunicaciones.
5) Resolución Exenta N° 470 de 13.02.2013, que Faculta a los Jefes de División y de Departamento para firmar “Por orden del Subsecretario de Telecomunicaciones” y delega las facultades que indica.

MAT.: Certifica equipo de alcance reducido.

DE : SUBSECRETARÍA DE TELECOMUNICACIONES

A : MBSERVICES

1. De acuerdo a la información proporcionada por documento de ANT. 1), esta Subsecretaría de Estado extiende el presente certificado para operar dentro del país, condicionado al estricto cumplimiento de lo señalado en letra j.1) del artículo 1° de la norma de ANT. 2).

- Tipo de equipo : Wi-Fi BLE Portrait Desk Lamp EU (Luminaria LED).
- Marca : WIZ.
- Modelo(s) : 9290032968.
- Fabricante : Signify (China) Investment Co., Ltd.
- Frecuencias de operación : BT: 2.400-2.483,5 ; WLAN 2,4G: 2.412-2.462 MHz.
- Potencia máxima radiada : BT: 4,79 mW (6,80 dBm) ; WLAN 2,4G: 71,12 mW (18,52 dBm).
- Restricciones : Estos equipos deben operar al interior de recintos cerrados y emplear técnicas de compartición de frecuencias.

2. El incumplimiento de lo dispuesto en el presente certificado, será sancionado de acuerdo a las disposiciones legales vigentes. Estos equipos no deberán provocar interferencias a servicios de concesionarias de telecomunicaciones y no estarán protegidos respecto de interferencias que eventualmente puedan recibir.

Saluda atentamente a Ud.,
Por orden del Subsecretario de Telecomunicaciones,

DISTRIBUCIÓN:

- MBservices: Laboratorio@mbservices.cl
- Oficina de Partes.

Francisco Javier Pizarro Sepulveda
Jefe División Fiscalización
29/04/2024 15:07





RF TEST REPORT

Applicant Espressif Systems (Shanghai) Co.,Ltd.
FCC ID 2AC7Z-ESPC3MINI1
Product Wi-Fi & Bluetooth Internet of Things Module
Brand ESPRESSIF
Model ESP32-C3-MINI-1
Report No. R2103A0270-R1V2
Issue Date June 7, 2021

TA Technology (Shanghai) Co., Ltd. tested the above equipment in accordance with the requirements in **FCC CFR47 Part 15C (2020)**. The test results show that the equipment tested is capable of demonstrating compliance with the requirements as documented in this report.

Prepared by: Peng Tao

Approved by: Kai Xu

TA Technology (Shanghai) Co., Ltd.

No.145, Jintang Rd, Tangzhen Industry Park, Pudong Shanghai, China

TEL: +86-021-50791141/2/3

FAX: +86-021-50791141/2/3-8000



TABLE OF CONTENT

1. Test Laboratory	5
1.1. Notes of the test report.....	5
1.2. Test facility	5
1.3. Testing Location.....	5
2. General Description of Equipment under Test.....	6
2.1. Applicant and Manufacturer Information.....	6
2.2. General information.....	6
3. Applied Standards	7
4. Test Configuration	8
5. Test Case Results	9
5.1. Maximum output power	9
5.2. 99% Bandwidth and 6dB Bandwidth	12
5.3. Band Edge	24
5.4. Power Spectral Density	29
5.5. Spurious RF Conducted Emissions.....	37
5.6. Unwanted Emission	44
5.7. Conducted Emission	104
6. Main Test Instruments.....	107
ANNEX A: The EUT Appearance	108
ANNEX B: Test Setup Photos	109



Version	Revision description	Issue Date
Rev.0	Initial issue of report.	June 1, 2021
Rev.1	Update Maximum output power and Power Spectral Density data	June 4, 2021
Rev.2	Update FCC ID	June 7, 2021
Note: This revised report (Report No. R2103A0270-R1V2) supersedes and replaces the previously issued report (Report No. R2103A0270-R1V1). Please discard or destroy the previously issued report and dispose of it accordingly.		



Summary of measurement results

Number	Test Case	Clause in FCC rules	Verdict
1	Maximum output power	15.247(b)(3)	PASS
2	6 dB bandwidth	15.247(a)(2)	PASS
3	Power spectral density	15.247(e)	PASS
4	Band Edge	15.247(d)	PASS
5	Spurious RF Conducted Emissions	15.247(d)	PASS
6	Unwanted Emissions	15.247(d),15.205,15.209	PASS
7	Conducted Emissions	15.207	PASS
Date of Testing: March 30, 2021 ~ April 30, 2021 and May 26, 2021~ May 31, 2021			
Date of Sample Received: March 17, 2021			
Note: All indications of Pass/Fail in this report are opinions expressed by TA Technology (Shanghai) Co., Ltd. based on interpretations and/or observations of test results. Measurement Uncertainties were not taken into account and are published for informational purposes only.			



1. Test Laboratory

1.1. Notes of the test report

This report shall not be reproduced in full or partial, without the written approval of **TA technology (shanghai) co., Ltd.** The results documented in this report apply only to the tested sample, under the conditions and modes of operation as described herein .Measurement Uncertainties were not taken into account and are published for informational purposes only. This report is written to support regulatory compliance of the applicable standards stated above.

1.2. Test facility

FCC (Designation number: CN1179, Test Firm Registration Number: 446626)

TA Technology (Shanghai) Co., Ltd. has been listed on the US Federal Communications Commission list of test facilities recognized to perform measurements.

A2LA (Certificate Number: 3857.01)

TA Technology (Shanghai) Co., Ltd. has been listed by American Association for Laboratory Accreditation to perform measurement.

1.3. Testing Location

Company: TA Technology (Shanghai) Co., Ltd.
Address: No.145, Jintang Rd, Tangzhen Industry Park, Pudong
City: Shanghai
Post code: 201201
Country: P. R. China
Contact: Xu Kai
Telephone: +86-021-50791141/2/3
Fax: +86-021-50791141/2/3-8000
Website: <http://www.ta-shanghai.com>
E-mail: xukai@ta-shanghai.com

2. General Description of Equipment under Test

2.1. Applicant and Manufacturer Information

Applicant	Espressif Systems (Shanghai) Co.,Ltd.
Applicant address	Suite 204, Block 2, 690 Bibo Road, Zhang Jiang Hi-Tech Park, Shanghai, China
Manufacturer	Espressif Systems (Shanghai) Co.,Ltd.
Manufacturer address	Suite 204, Block 2, 690 Bibo Road, Zhang Jiang Hi-Tech Park, Shanghai, China

2.2. General information

EUT Description	
Model	ESP32-C3-MINI-1
Lab internal SN	R2103A0270/S01
Hardware Version	V1.4
Software Version	V1.1.3.0
Power Supply	External power supply
Antenna Type	PCB Antenna
Antenna Connector	A permanently attached antenna (meet with the standard FCC Part 15.203 requirement)
Antenna Gain	3.96 dBi
additional beamforming gain	NA
Test Mode	802.11b, 802.11g, 802.11n(HT20/HT40) Bluetooth LE V5.0
Modulation Type	802.11b: DSSS 802.11g/n(HT20/HT40): OFDM Bluetooth LE: GFSK
Max. Conducted Power	Wi-Fi 2.4G: 18.52dBm Bluetooth LE: 6.80 dBm
Operating Frequency Range(s)	802.11b/g/n(HT20): 2412 ~ 2462 MHz 802.11n(HT40): 2422 ~ 2452 MHz Bluetooth LE: 2402 ~2480 MHz
Note: 1. The EUT is sent from the applicant to TA and the information of the EUT is declared by the applicant.	



3. Applied Standards

According to the specifications of the manufacturer, it must comply with the requirements of the following standards:

Test standards:

FCC CFR47 Part 15C (2020) Radio Frequency Devices

ANSI C63.10 (2013)

Reference standard:

KDB 558074 D01 15.247 Meas Guidance v05r02

4. Test Configuration

Test Mode

The EUT has been associated with peripherals and configuration operated in a manner tended to maximize its emission characteristics in a typical application.

The radiated emission was measured in the following position: EUT stand-up position (Z axis), lie-down position (X, Y axis). The worst emission was found in lie-down position (X axis) and the loop antenna is vertical, the others are vertical and horizontal. and the worst case was recorded.

In order to find the worst case condition, Pre-tests are needed at the presence of different data rate. Preliminary tests have been done on all the configuration for confirming worst case. Data rate below means worst-case rate of each test item.

Worst-case data rates are shown as following table.

Test Mode	Data Rate
Bluetooth(Low Energy)	1Mbps, 2Mbps
802.11b	1 Mbps
802.11g	6 Mbps
802.11n HT20	MCS0
802.11n HT40	MCS0

5. Test Case Results

5.1. Maximum output power

Ambient condition

Temperature	Relative humidity	Pressure
23°C ~25°C	45%~50%	101.5kPa

Methods of Measurement

During the process of the testing, The EUT was connected to Power meter with a known loss. The EUT is max power transmission with proper modulation.

Test Setup

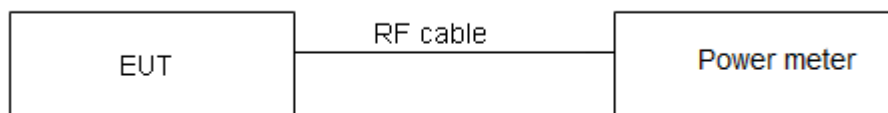

Limits

Rule Part 15.247 (b) (3) specifies that " For systems using digital modulation in the 902–928 MHz, 2400–2483.5 MHz: 1 Watt."

Average Output Power	$\leq 1W$ (30dBm)
----------------------	-------------------

Measurement Uncertainty

The assessed measurement uncertainty to ensure 95% confidence level for the normal distribution is with the coverage factor $k = 2$, $U = 0.44$ dB.



Test Results

Power Index					
Channel	802.11b	802.11g	802.11n HT20	Channel	802.11n HT40
CH1	0	16	20	CH3	24
CH2	0	0	0	CH4	16
CH6	0	0	0	CH5	8
CH10	0	0	0	CH6	0
CH11	0	16	16	CH7	8
/	/	/	/	CH8	12
/	/	/	/	CH9	20

Test Mode	T _{on} (ms)	T _(on+off) (ms)	Duty cycle	Duty cycle correction Factor(dB)
802.11b	1.00	1.00	1.00	NA
802.11g	1.00	1.00	1.00	NA
802.11n HT20	1.00	1.00	1.00	NA
802.11n HT40	1.00	1.00	1.00	NA
Bluetooth LE (1M)	2.10	2.51	0.837	0.771
Bluetooth LE (2M)	1.07	1.88	0.567	2.465

Note: when Duty cycle ≥ 0.98 , Duty cycle correction Factor not required.

Test Mode	Carrier frequency (MHz)	Average Power Measured (dBm)	Average Power with duty factor (dBm)	Limit (dBm)	Conclusion
802.11b	2412	17.48	17.48	30	PASS
	2417	17.67	17.67	30	PASS
	2437	17.75	17.75	30	PASS
	2457	18.52	18.52	30	PASS
	2462	17.51	17.51	30	PASS
802.11g	2412	13.88	13.88	30	PASS
	2417	17.43	17.43	30	PASS
	2437	17.80	17.80	30	PASS
	2457	18.37	18.37	30	PASS
	2462	14.15	14.15	30	PASS



802.11n HT20	2412	12.05	12.05	30	PASS
	2417	16.70	16.70	30	PASS
	2437	16.63	16.63	30	PASS
	2457	17.53	17.53	30	PASS
	2462	13.42	13.42	30	PASS
802.11n HT40	2422	10.61	10.61	30	PASS
	2427	12.11	12.11	30	PASS
	2432	14.58	14.58	30	PASS
	2437	16.01	16.01	30	PASS
	2442	14.82	14.82	30	PASS
	2447	13.86	13.86	30	PASS
	2452	11.52	11.52	30	PASS
Bluetooth (Low Energy) (1M)	2402	4.24	5.01	30	PASS
	2440	5.95	6.72	30	PASS
	2480	5.68	6.45	30	PASS
Bluetooth (Low Energy) (2M)	2402	1.83	4.30	30	PASS
	2440	4.33	6.80	30	PASS
	2480	4.07	6.54	30	PASS
Note: Average Power with duty factor = Average Power Measured +Duty cycle correction factor					

5.2. 99% Bandwidth and 6dB Bandwidth

Ambient condition

Temperature	Relative humidity	Pressure
23°C ~25°C	45%~50%	101.5kPa

Method of Measurement

The EUT was connected to the spectrum analyzer through an external attenuator (20dB) and a known loss cable. RBW is set to 100 kHz; VBW is set to 300 kHz on spectrum analyzer. Dector=Peak, Trace mode=max hold.

The EUT was connected to the spectrum analyzer through a known loss cable. The resolution bandwidth (RBW) shall be in the range of 1% to 5% of the actual occupied / x dB bandwidth and the video bandwidth (VBW) shall not be smaller than three times the RBW value.

Test Setup

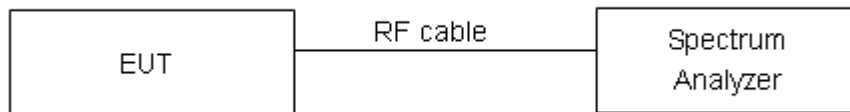

Limits

Rule Part 15.247 (a) (2) specifies that “Systems using digital modulation techniques may operate in the 902–928 MHz, 2400–2483.5 MHz bands. The minimum 6 dB bandwidth shall be at least 500 kHz.”

minimum 6 dB bandwidth	≥ 500 kHz
------------------------	-----------

Measurement Uncertainty

The assessed measurement uncertainty to ensure 95% confidence level for the normal distribution is with the coverage factor $k = 2$, $U = 936$ Hz.

**Test Results:**

Test Mode	Carrier frequency (MHz)	99% bandwidth (MHz)	Minimum 6 dB bandwidth (MHz)	Limit (kHz)	Conclusion
802.11b	2412	13.047	9.571	500	PASS
	2417	13.075	9.111	500	PASS
	2437	13.023	9.560	500	PASS
	2457	13.104	9.563	500	PASS
	2462	13.045	9.100	500	PASS
802.11g	2412	16.861	16.380	500	PASS
	2417	16.967	16.380	500	PASS
	2437	16.827	16.390	500	PASS
	2457	17.097	16.380	500	PASS
	2462	16.878	16.400	500	PASS
802.11n HT20	2412	17.894	17.630	500	PASS
	2417	17.924	17.610	500	PASS
	2437	17.897	17.620	500	PASS
	2457	17.978	17.630	500	PASS
	2462	17.915	17.630	500	PASS
802.11n HT40	2422	34.624	32.740	500	PASS
	2427	34.625	32.720	500	PASS
	2432	34.708	32.730	500	PASS
	2437	34.676	32.720	500	PASS
	2442	34.684	32.730	500	PASS
	2447	34.711	32.730	500	PASS
	2452	34.751	32.720	500	PASS
Bluetooth (Low Energy) (1M)	2402	1.0278	0.6395	500	PASS
	2440	1.0264	0.6362	500	PASS
	2480	1.0275	0.6394	500	PASS
Bluetooth (Low Energy) (2M)	2402	2.0476	1.1110	500	PASS
	2440	2.0432	1.1110	500	PASS
	2480	2.0476	1.1120	500	PASS

99%bandwidth

802.11b, Carrier frequency (MHz): 2412



802.11g, Carrier frequency (MHz): 2412

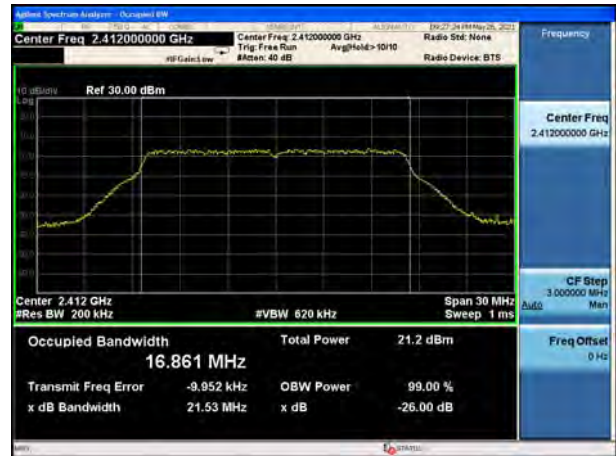

802.11b, Carrier frequency (MHz): 2417



802.11g, Carrier frequency (MHz): 2417



802.11b, Carrier frequency (MHz): 2437



802.11g, Carrier frequency (MHz): 2437



802.11b, Carrier frequency (MHz): 2457



802.11g, Carrier frequency (MHz): 2457



802.11b, Carrier frequency (MHz): 2462



802.11g, Carrier frequency (MHz): 2462



802.11n(HT20), Carrier frequency (MHz): 2412

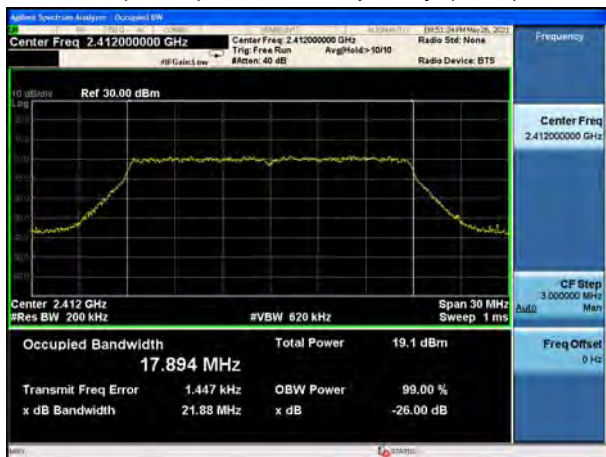

802.11n(HT40), Carrier frequency (MHz): 2422

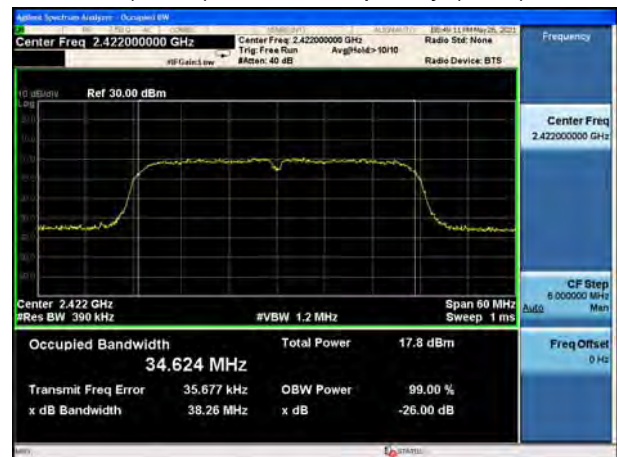

802.11n(HT20), Carrier frequency (MHz): 2417

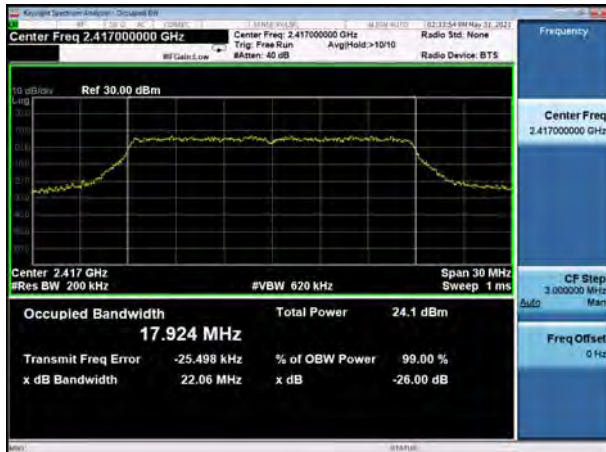

802.11n(HT40), Carrier frequency (MHz): 2427



802.11n(HT20), Carrier frequency (MHz): 2437

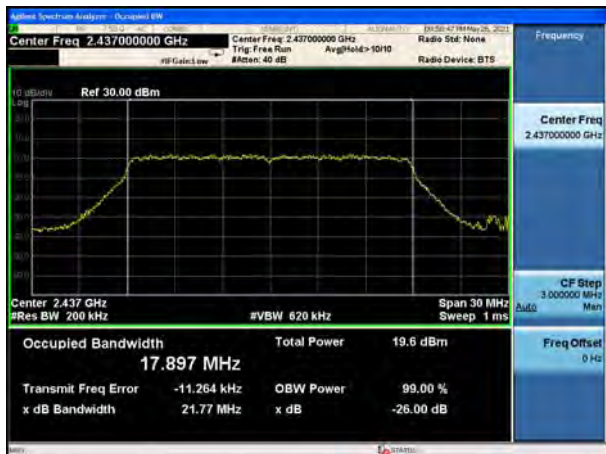

802.11n(HT40), Carrier frequency (MHz): 2433



802.11n(HT20), Carrier frequency (MHz): 2457



802.11n(HT40), Carrier frequency (MHz): 2437



802.11n(HT20), Carrier frequency (MHz):2462



802.11n(HT40), Carrier frequency (MHz):2442

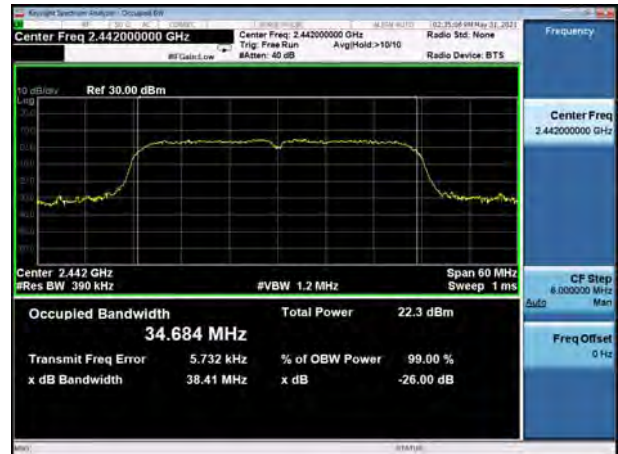

802.11n(HT40), Carrier frequency (MHz):2447

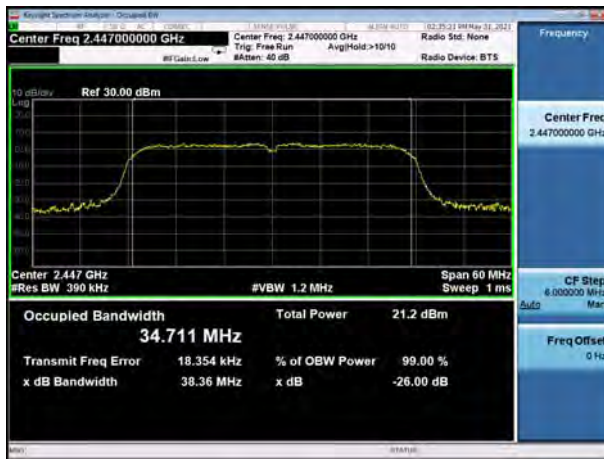

802.11n(HT40), Carrier frequency (MHz):2452

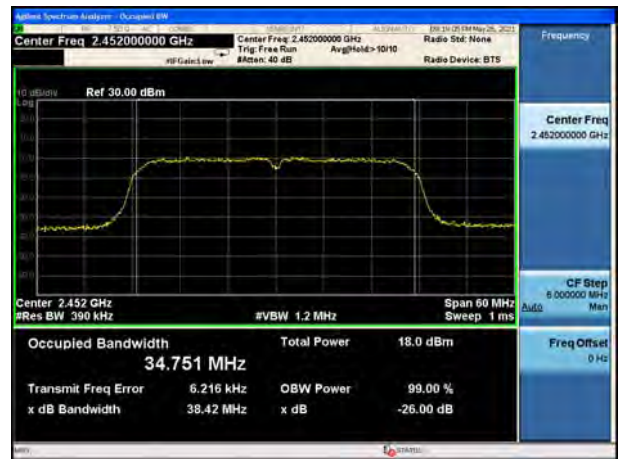

Bluetooth LE (1M) Carrier frequency (MHz):
2402



Bluetooth LE (2M) Carrier frequency (MHz):
2402



Bluetooth LE (1M) Carrier frequency (MHz):
2440



Bluetooth LE (2M) Carrier frequency (MHz):
2440



Bluetooth LE (1M) Carrier frequency (MHz):
2480



Bluetooth LE (2M) Carrier frequency (MHz):
2480





6 dB bandwidth

802.11b, Carrier frequency (MHz): 2412

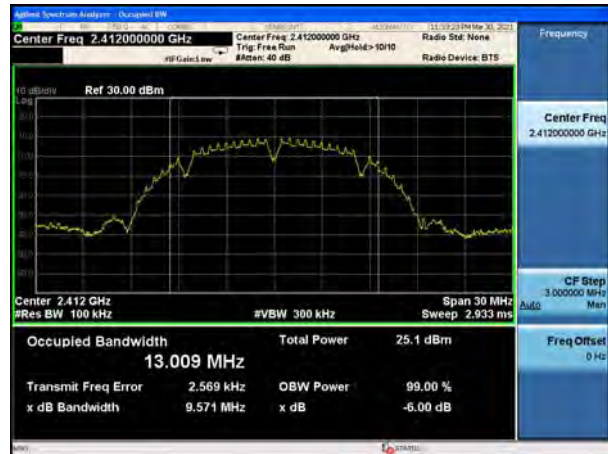

802.11g, Carrier frequency (MHz): 2412

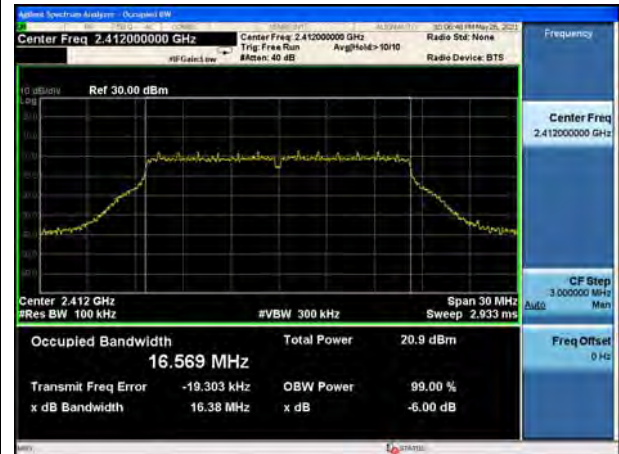

802.11b, Carrier frequency (MHz): 2417



802.11g, Carrier frequency (MHz): 2417



802.11b, Carrier frequency (MHz): 2437



802.11g, Carrier frequency (MHz): 2437

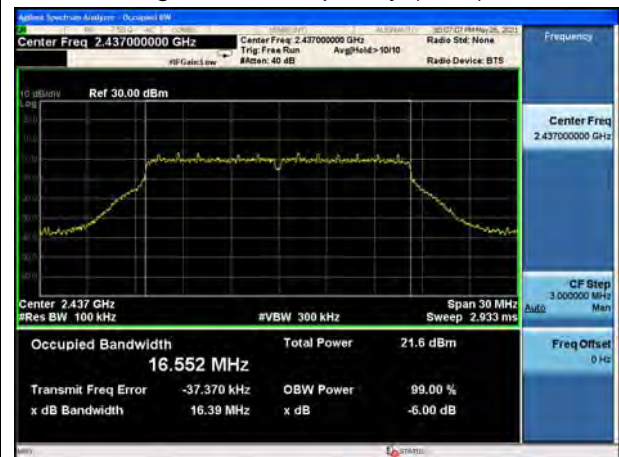

802.11b, Carrier frequency (MHz): 2457



802.11g, Carrier frequency (MHz): 2457



802.11b, Carrier frequency (MHz): 2462

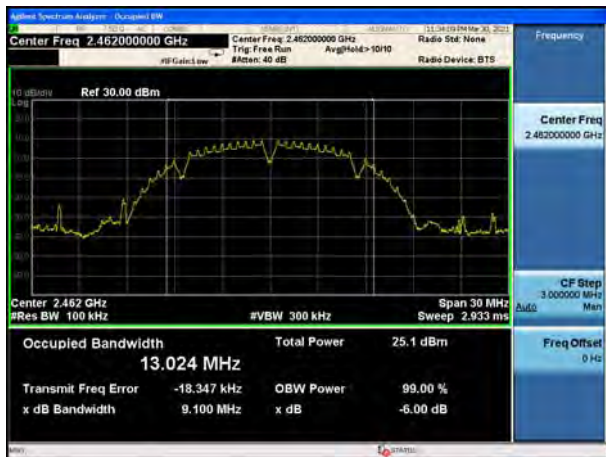

802.11g, Carrier frequency (MHz): 2462

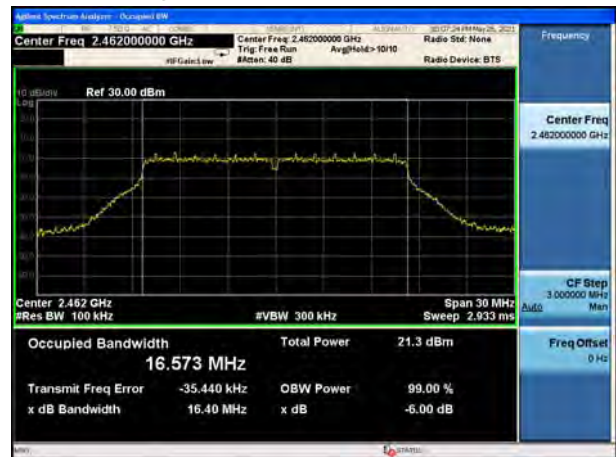

802.11n(HT20), Carrier frequency (MHz): 2412

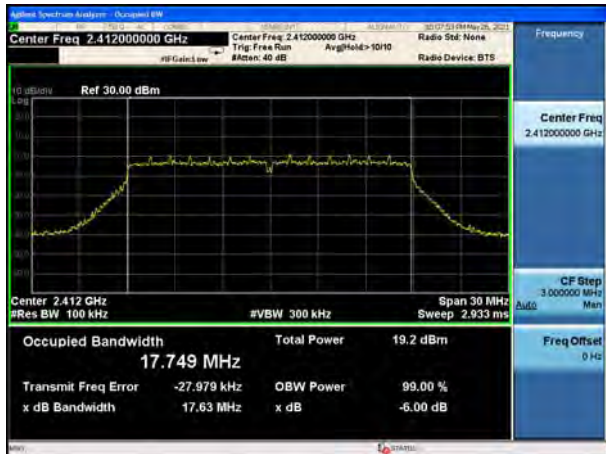

802.11n(HT40), Carrier frequency (MHz): 2422

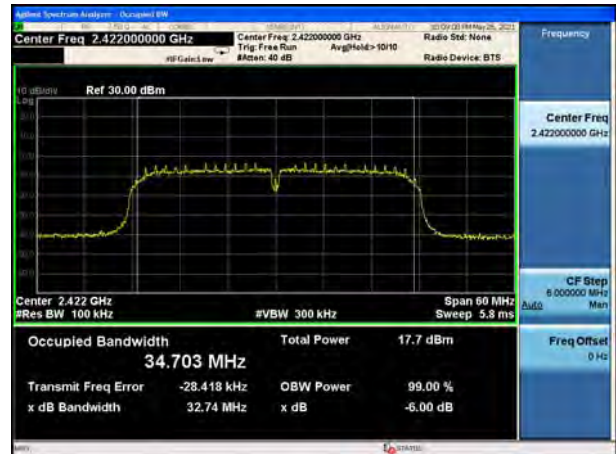



802.11n(HT20), Carrier frequency (MHz): 2417



802.11n(HT40), Carrier frequency (MHz): 2427



802.11n(HT20), Carrier frequency (MHz): 2437



802.11n(HT40), Carrier frequency (MHz): 2433



802.11n(HT20), Carrier frequency (MHz): 2457



802.11n(HT40), Carrier frequency (MHz): 2437

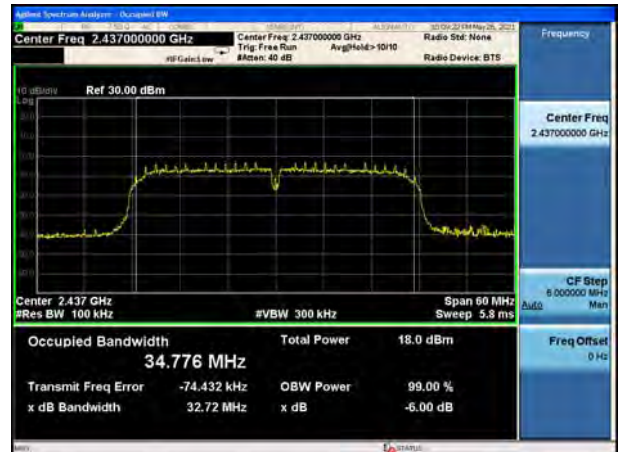

802.11n(HT20), Carrier frequency (MHz):2462

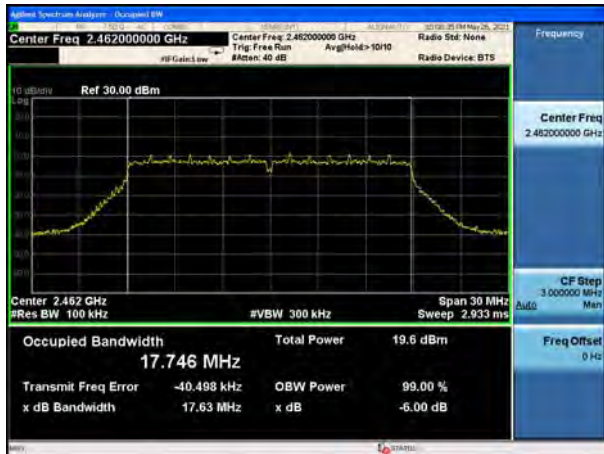

802.11n(HT40), Carrier frequency (MHz):2442



802.11n(HT40), Carrier frequency (MHz):2447



802.11n(HT40), Carrier frequency (MHz):2452



Bluetooth LE (1M) Carrier frequency (MHz):
2402



Bluetooth LE (2M) Carrier frequency (MHz):
2402



Bluetooth LE (1M) Carrier frequency (MHz):
2440



Bluetooth LE (2M) Carrier frequency (MHz):
2440



Bluetooth LE (1M) Carrier frequency (MHz):
2480



Bluetooth LE (2M) Carrier frequency (MHz):
2480



5.3. Band Edge

Ambient condition

Temperature	Relative humidity	Pressure
23°C ~25°C	45%~50%	101.5kPa

Method of Measurement

The EUT was connected to the spectrum analyzer through an external attenuator (20dB) and a known loss cable the band edge of the lowest and highest channels were measured. The peak detector is used and RBW is set to 100 kHz and VBW is set to 300 kHz on spectrum analyzer. Spectrum analyzer plots are included on the following pages.

Test Setup

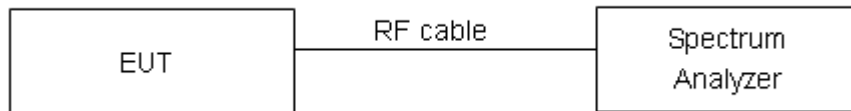

Limits

Rule Part 15.247(d) specifies that “In any 100 kHz bandwidth outside the frequency band in which the spread spectrum or digitally modulated intentional radiator is operating, the radio frequency power that is produced by the intentional radiator shall be at least 20 dB below that in the 100 kHz bandwidth within the band that contains the highest level of the desired power, based on either an RF conducted or a radiated measurement, provided the transmitter demonstrates compliance with the peak conducted power limits.” If the transmitter complies with the conducted power limits based on the use of RMS averaging over a time interval, as permitted under paragraph (b)(3) of this section, the attenuation required under this paragraph shall be 30 dB instead of 20 dB.”

Measurement Uncertainty

The assessed measurement uncertainty to ensure 95% confidence level for the normal distribution is with the coverage factor $k = 1.96$.

Frequency	Uncertainty
2GHz-3GHz	1.407 dB



Test Results: PASS

802.11b, Channel No.: 1

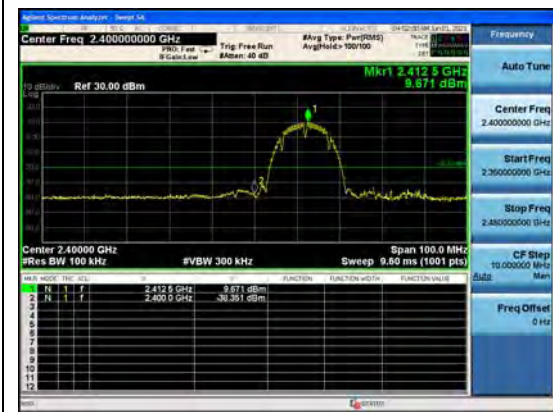

802.11b, Channel No.: 2



802.11b, Channel No.: 10

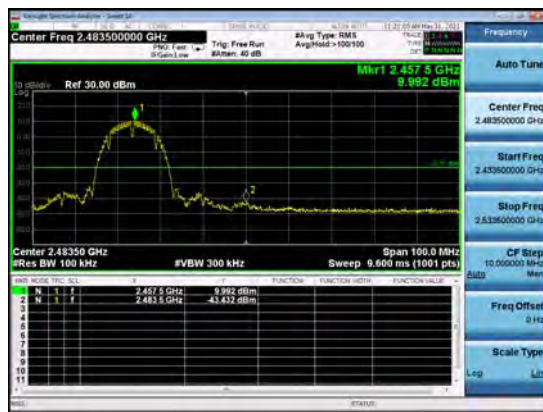

802.11b, Channel No.: 11

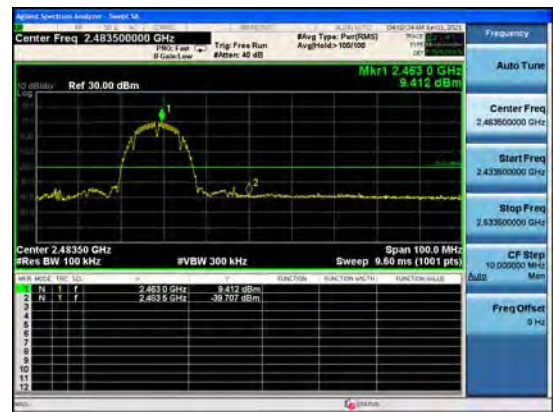

802.11g, Channel No.: 1

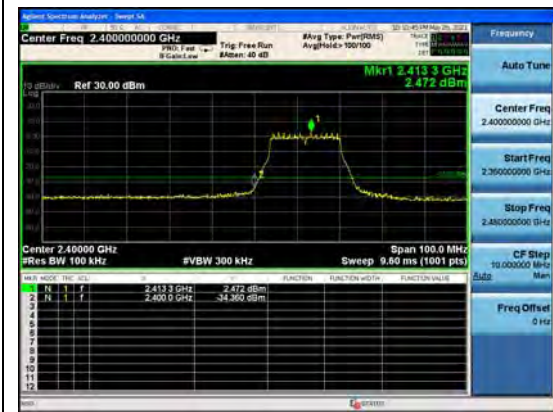

802.11g, Channel No.: 2



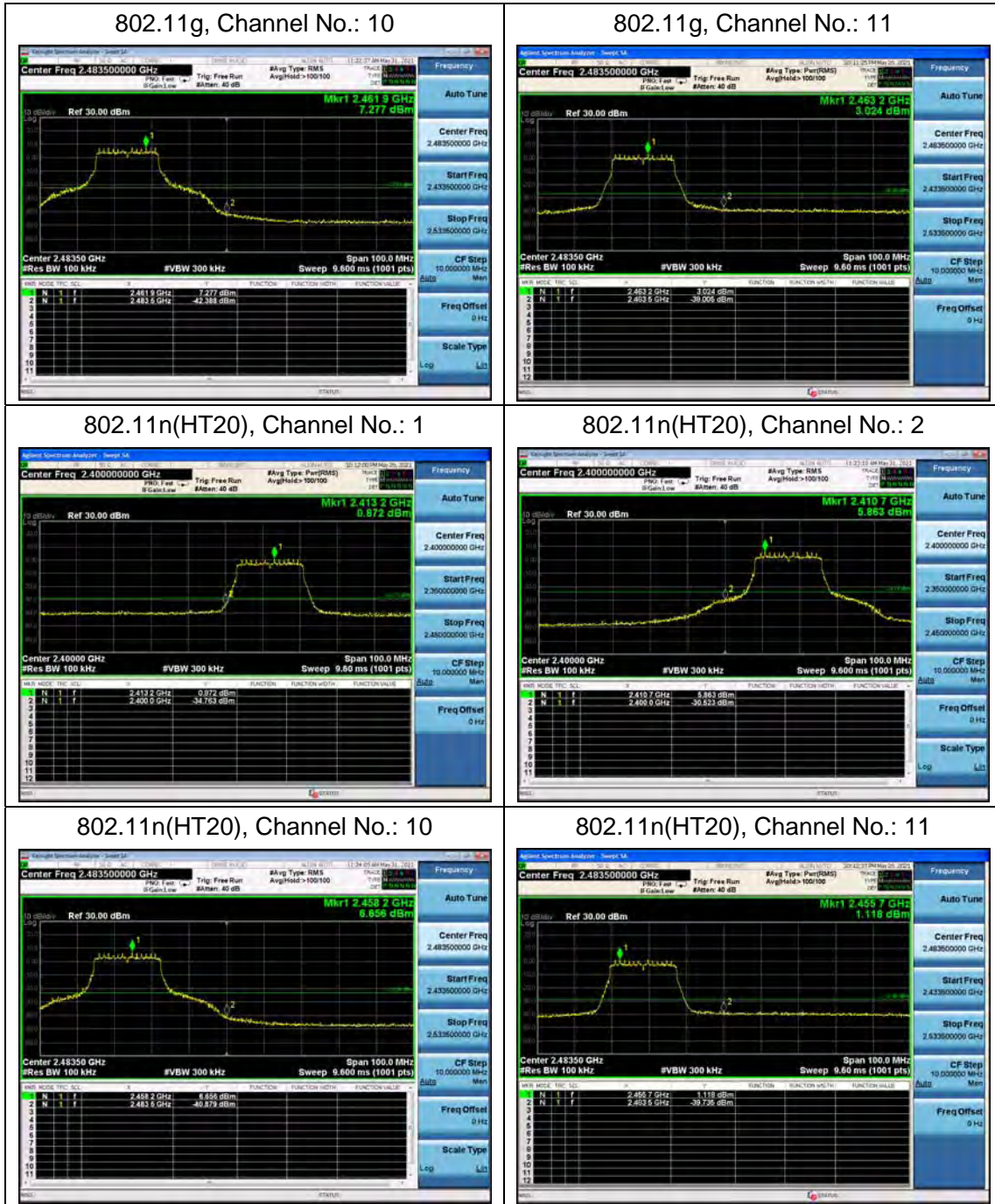

802.11n(HT40), Channel No.: 3

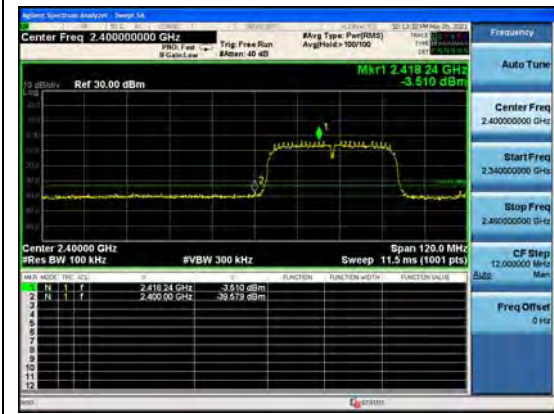

802.11n(HT40), Channel No.: 4

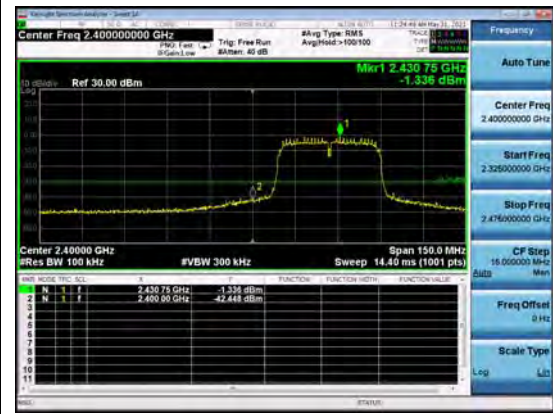

802.11n(HT40), Channel No.: 5

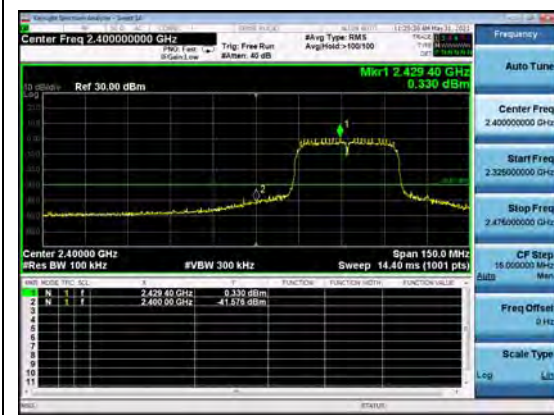

802.11n(HT40), Channel No.: 7



802.11n(HT40), Channel No.: 8

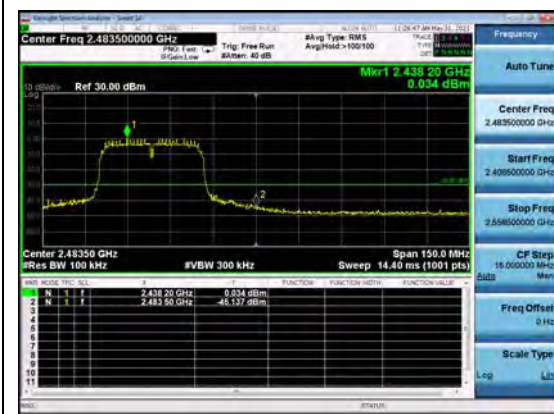

802.11n(HT40), Channel No.: 9



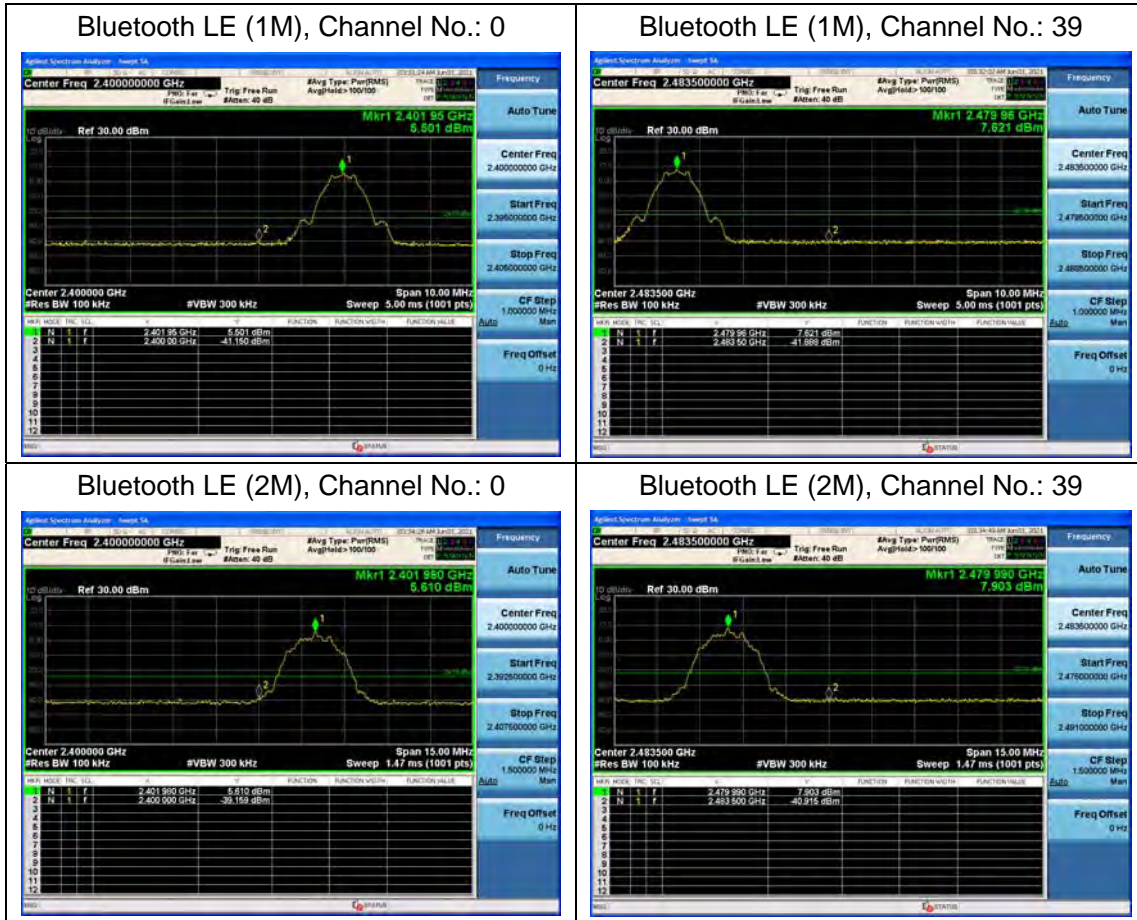

5.4. Power Spectral Density

Ambient condition

Temperature	Relative humidity	Pressure
23°C ~25°C	45%~50%	101.5kPa

Method of Measurement

During the process of the testing, The EUT was connected to Spectrum Analyzer with a known loss. The EUT is max power transmission with proper modulation.

Method AVGPSD-1 was used for this test.

- a) Set instrument center frequency to DTS channel center frequency
- b) Set span to at least 1.5 times the OBW
- c) Set RBW to: $3\text{kHz} \leq \text{RBW} \leq 100\text{kHz}$
- d) Set VBW $\geq [3 \times \text{RBW}]$
- e) Detector=power averaging(rms) or sample detector(when rms not available)
- f) Ensure that the number of measurement points in the sweep $2[2 \times \text{span}/\text{RBWT}]$
- g) Sweep time auto couple
- h) Employ trace averaging(rms) mode over a minimum of 100 traces
- i) Use the peak marker function to determine the maximum amplitude level.
- j) If the measured value exceeds requirement, then reduce RBW (but no less than 3 kHz) and repeat(note that this may require zooming in on the emission of interest and reducing the span to meet the minimum measurement point requirement as the RBW is reduced)

Method AVGPSD-2 was used for this test.

- a) Measure the duty cycle(D)of the transmitter output signal as described in 11.6
- b) Set instrument center frequency to DTS channel center frequency
- c) Set span to at least 1.5 times the OBW
- d) Set RBW to: $3\text{kHz} \leq \text{RBW} \leq 100\text{Kh}$
- e) Set VBW $\geq [3 \times \text{RBW}]$
- f) Detector= power averaging(rms) or sample detector (when rms not available)
- g) Ensure that the number of measurement points in the sweep $2[2 \times \text{span}/\text{RBW}]$
- h) Sweep time =auto couple
- i) Do not use sweep triggering; allow sweep to "free run"
- j) Employ trace averaging(rms) mode over a minimum of 100 traces
- k) Use the peak marker function to determine the maximum amplitude level
- l) Add $[10 \log(1/ D)]$, where D is the duty cycle measured in step a), to the measured PSD to

compute the average PSD during the actual transmission time

m) If measured value exceeds requirement specified by regulatory agency then reduce RBW (but no less than 3 kHz) and repeat (note that this may require zooming in on the emission of interest and reducing the span to meet the minimum measurement point requirement as the RBW is reduced)

Test setup

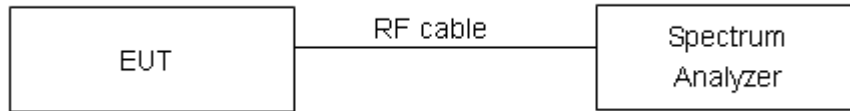

Limits

Rule Part 15.247(e) specifies that " For digitally modulated systems, the power spectral density conducted from the intentional radiator to the antenna shall not be greater than 8 dBm in any 3 kHz band during any time interval of continuous transmission. "

Limits	$\leq 8 \text{ dBm} / 3\text{kHz}$
--------	------------------------------------

Measurement Uncertainty

The assessed measurement uncertainty to ensure 95% confidence level for the normal distribution is with the coverage factor $k = 2$, $U = 0.75\text{dB}$.

**Test Results:**

Test Mode	Channel Number	Read Value (dBm / 3kHz)	Power Spectral Density (dBm / 3kHz)	Limit (dBm / 3kHz)	Conclusion
802.11b	1	-14.82	-14.82	8	PASS
	2	-14.97	-14.97	8	PASS
	6	-14.37	-14.37	8	PASS
	10	-13.75	-13.75	8	PASS
	11	-14.71	-14.71	8	PASS
802.11g	1	-21.01	-21.01	8	PASS
	2	-17.14	-17.14	8	PASS
	6	-16.78	-16.78	8	PASS
	10	-16.64	-16.64	8	PASS
	11	-20.71	-20.71	8	PASS
802.11n HT20	1	-22.95	-22.95	8	PASS
	2	-18.06	-18.06	8	PASS
	6	-17.62	-17.62	8	PASS
	10	-17.34	-17.34	8	PASS
	11	-22.74	-22.74	8	PASS
802.11n HT40	3	-26.82	-26.82	8	PASS
	4	-24.97	-24.97	8	PASS
	5	-22.73	-22.73	8	PASS
	6	-20.85	-20.85	8	PASS
	7	-22.39	-22.39	8	PASS
	8	-23.53	-23.53	8	PASS
	9	-26.61	-26.61	8	PASS
Bluetooth (Low Energy) (1M)	0	-16.15	-15.38	8	PASS
	19	-13.90	-13.13	8	PASS
	39	-14.70	-13.93	8	PASS
Bluetooth (Low Energy) (2M)	0	-16.22	-13.76	8	PASS
	19	-13.84	-11.38	8	PASS
	39	-13.48	-11.01	8	PASS

Note: Power Spectral Density =Read Value+Duty cycle correction factor



802.11b, Channel No.: 1



802.11g, Channel No.: 1

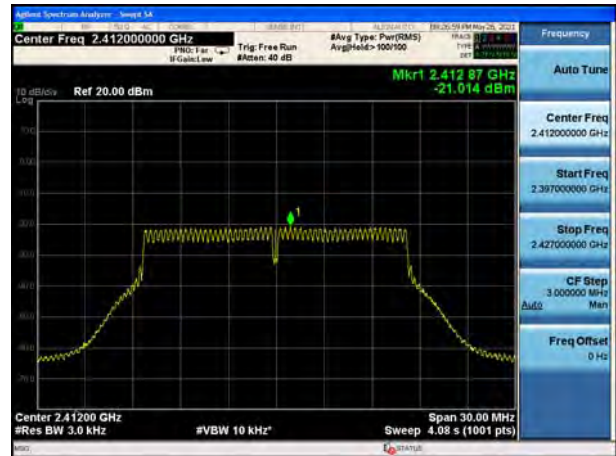

802.11b, Channel No.: 2



802.11g, Channel No.: 2

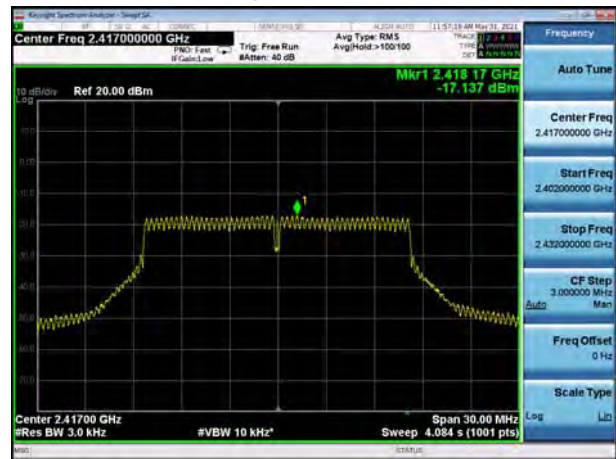

802.11b, Channel No.: 6



802.11g, Channel No.: 6

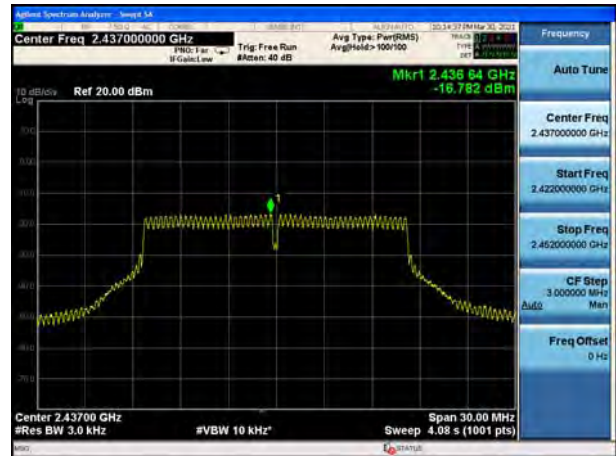



802.11b, Channel No.: 10



802.11g, Channel No.: 10

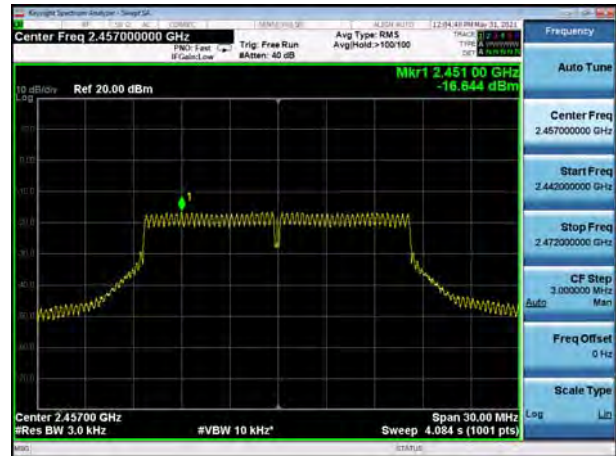

802.11b, Channel No.: 11



802.11g, Channel No.: 11

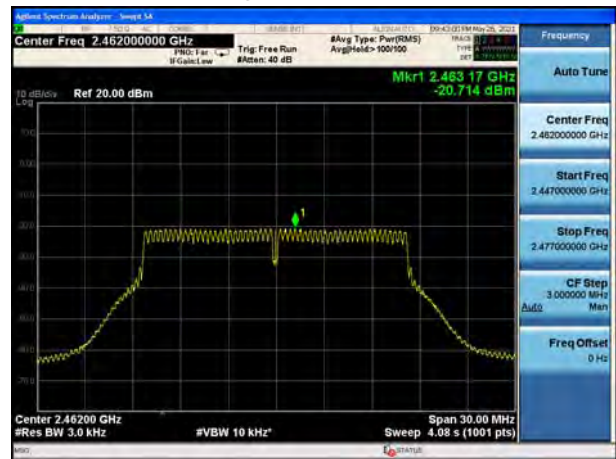

802.11n(HT20), Channel No. 1

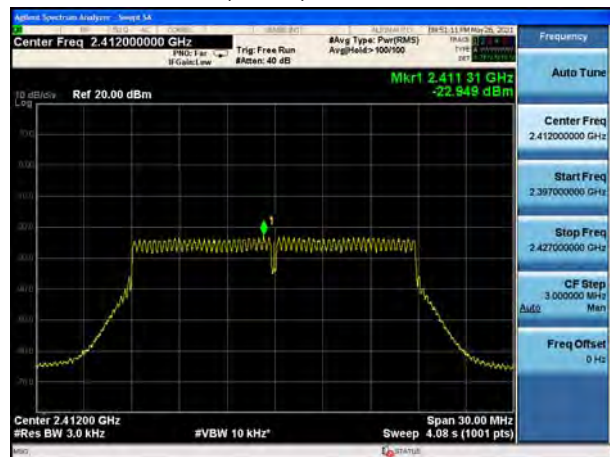

802.11n(HT40), Channel No. 3

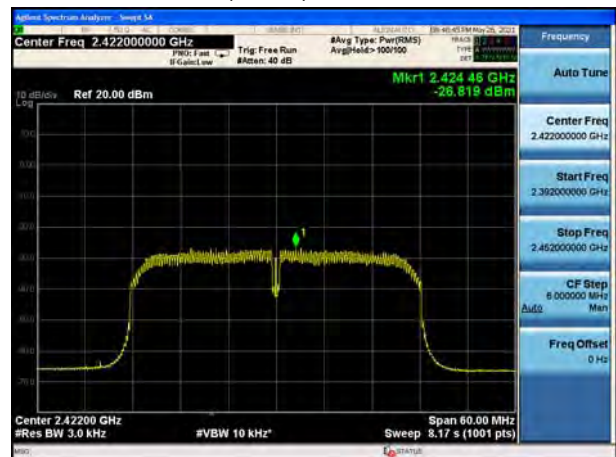



802.11n(HT20), Channel No. 2

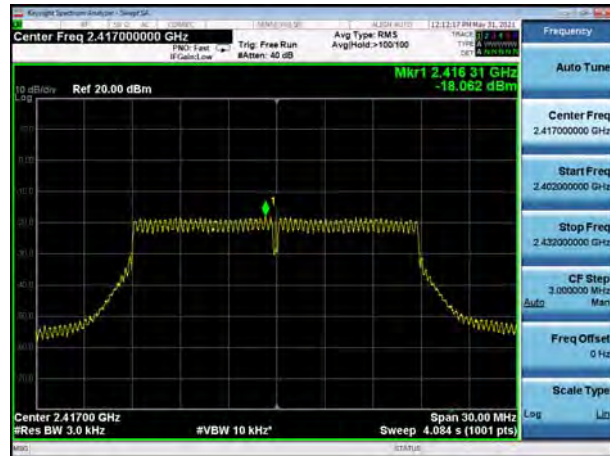

802.11n(HT40), Channel No. 4

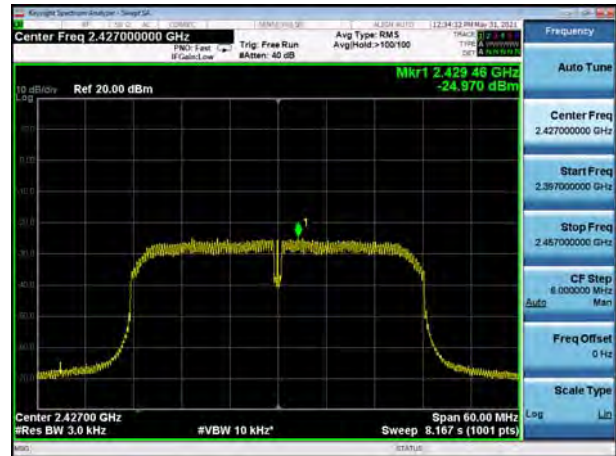

802.11n(HT20), Channel No. 6

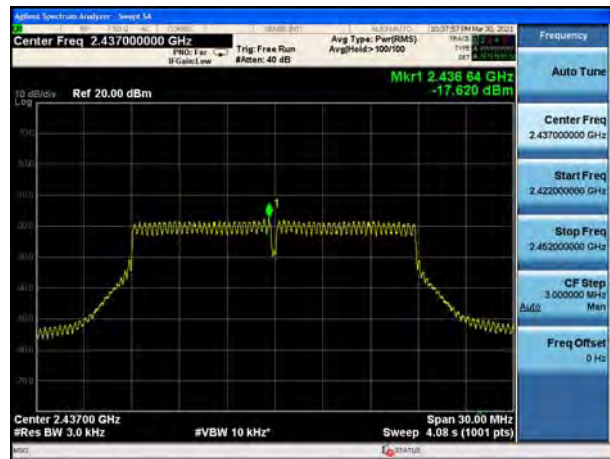

802.11n(HT40), Channel No. 5

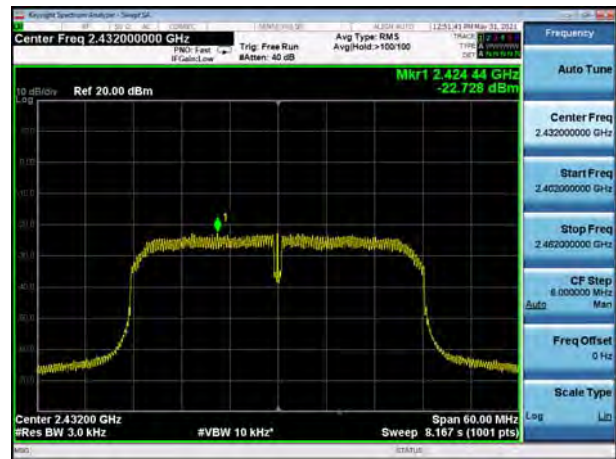

802.11n(HT20), Channel No. 10

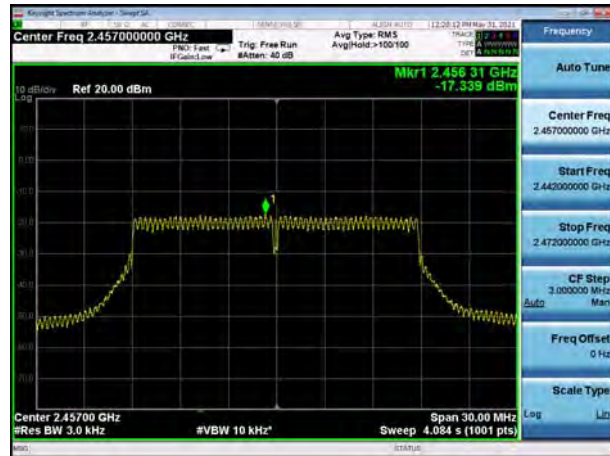

802.11n(HT40), Channel No. 6





802.11n(HT20), Channel No. 11

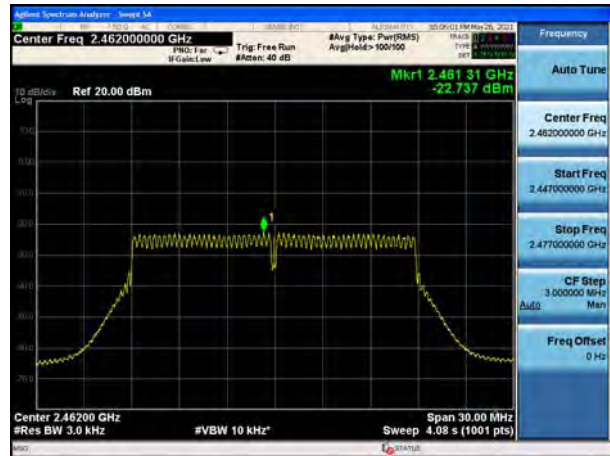

802.11n(HT40), Channel No. 7

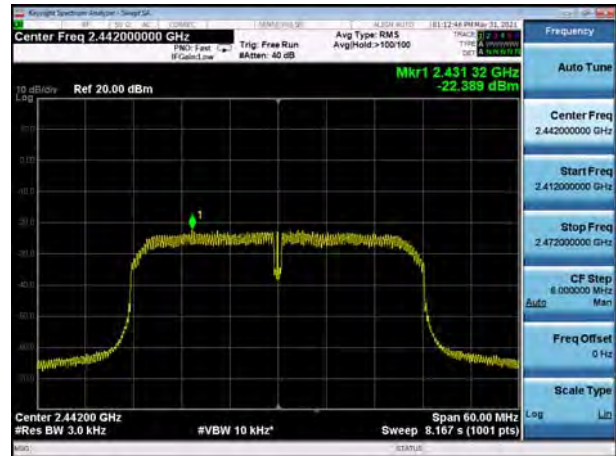

802.11n(HT40), Channel No. 8

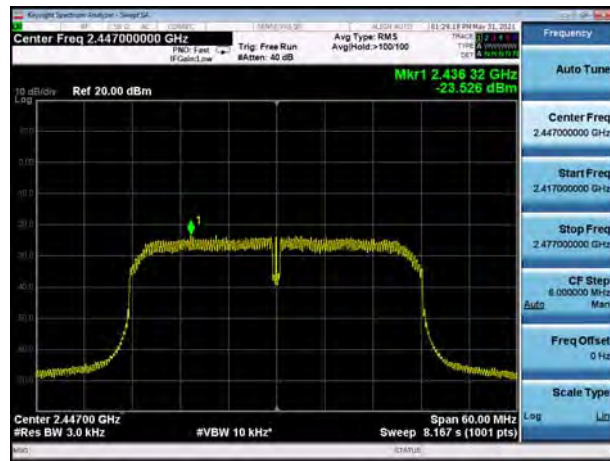

802.11n(HT40), Channel No. 9

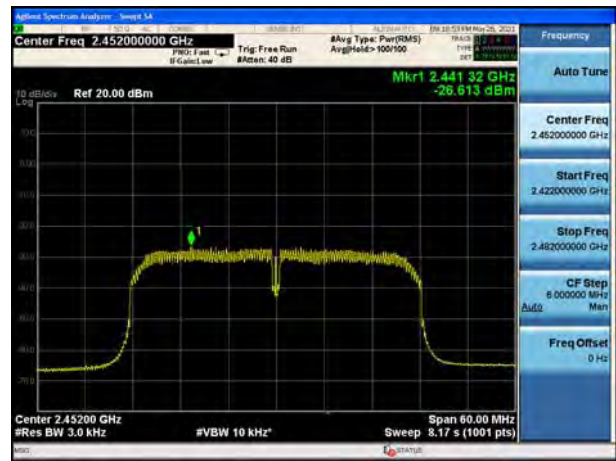



Bluetooth LE (1M), Channel No.: 0



Bluetooth LE (2M), Channel No.: 0



Bluetooth LE (1M), Channel No.: 19



Bluetooth LE (2M), Channel No.: 19



Bluetooth LE (1M), Channel No.: 39



Bluetooth LE (2M), Channel No.: 39



5.5. Spurious RF Conducted Emissions

Ambient condition

Temperature	Relative humidity	Pressure
23°C ~25°C	45%~50%	101.5kPa

Method of Measurement

The EUT was connected to the spectrum analyzer with a known loss. The spectrum analyzer scans from 30MHz to the 10th harmonic of the carrier. The peak detector is used. Set RBW to 100 kHz and VBW to 300 kHz, Sweep is set to ATUO.

The test is in transmitting mode.

Test setup



Limits

Rule Part 15.247(d) pacifies that “In any 100 kHz bandwidth outside the frequency band in which the spread spectrum or digitally modulated intentional radiator is operating, the radio frequency power that is produced by the intentional radiator shall be at least 20 dB below that in the 100 kHz bandwidth within the band that contains the highest level of the desired power, based on either an RF conducted or a radiated measurement, provided the transmitter demonstrates compliance with the peak conducted power limits. If the transmitter complies with the conducted power limits based on the use of RMS averaging over a time interval, as permitted under paragraph (b)(3) of this section, the attenuation required under this paragraph shall be 30 dB instead of 20 dB. ”

Test Mode	Carrier frequency (MHz)	Reference value (dBm)	Limit
802.11b	2412	8.88	-21.12
	2417	8.48	-21.52
	2437	7.86	-22.14
	2457	9.21	-20.79
	2462	9.09	-20.91
802.11g	2412	2.87	-27.13
	2417	5.14	-24.86
	2437	2.10	-27.90
	2457	6.58	-23.42
	2462	3.31	-26.69
802.11n HT20	2412	1.11	-28.90
	2417	4.97	-25.03
	2437	-1.77	-31.77
	2457	5.98	-24.02
	2462	1.96	-28.04
802.11n HT40	2422	-3.44	-33.44
	2427	-1.31	-31.31
	2432	0.19	-29.82
	2437	-3.41	-33.41
	2442	1.27	-28.73
	2447	0.05	-29.95
	2452	-2.34	-32.34
Bluetooth (Low Energy) (1M)	2402	6.14	-23.86
	2440	8.08	-21.92
	2480	8.64	-21.36
Bluetooth (Low Energy) (2M)	2402	6.99	-23.01
	2440	5.60	-24.40
	2480	8.73	-21.27

Measurement Uncertainty

The assessed measurement uncertainty to ensure 95% confidence level for the normal distribution is with the coverage factor $k = 1.96$.

Frequency	Uncertainty
100kHz-2GHz	0.684 dB
2GHz-26GHz	1.407 dB



Test Results:

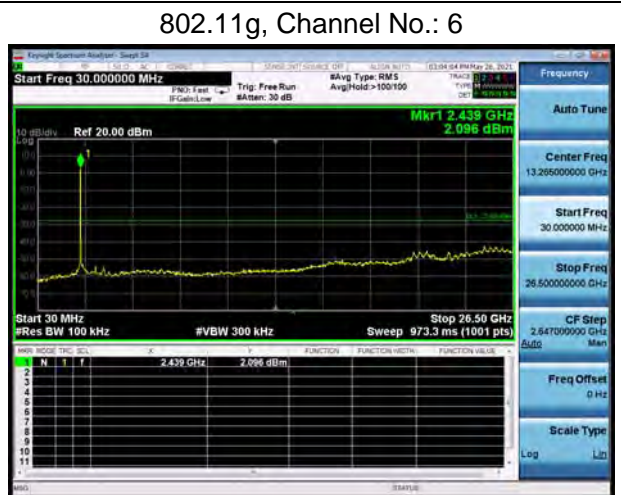
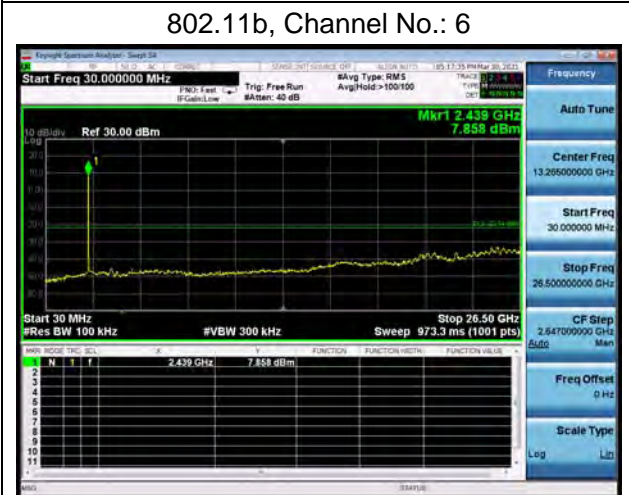
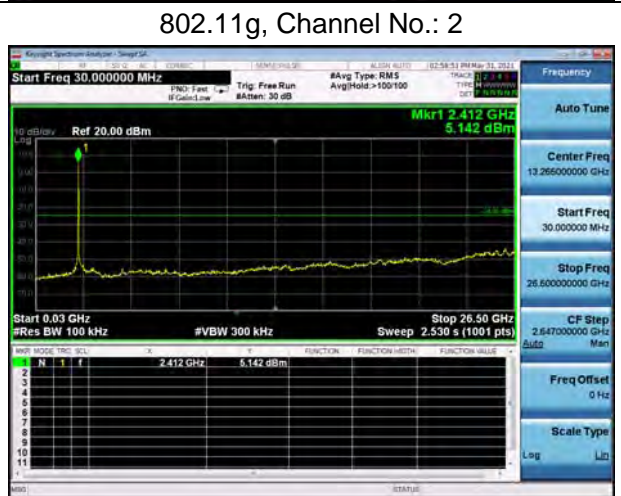
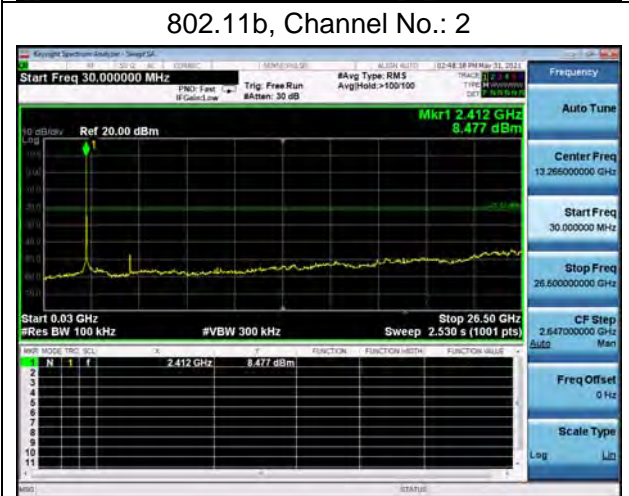
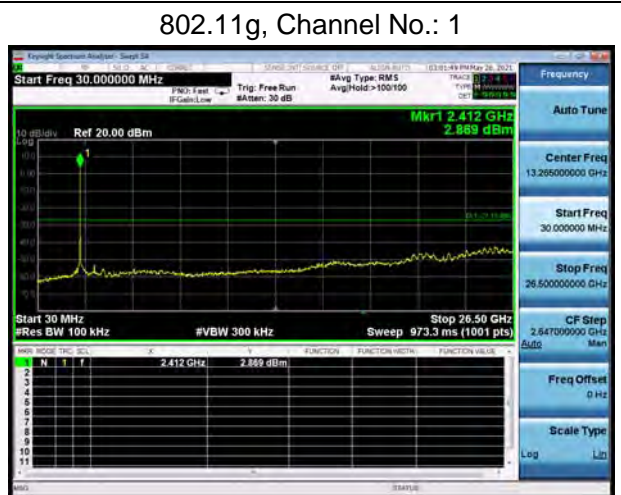
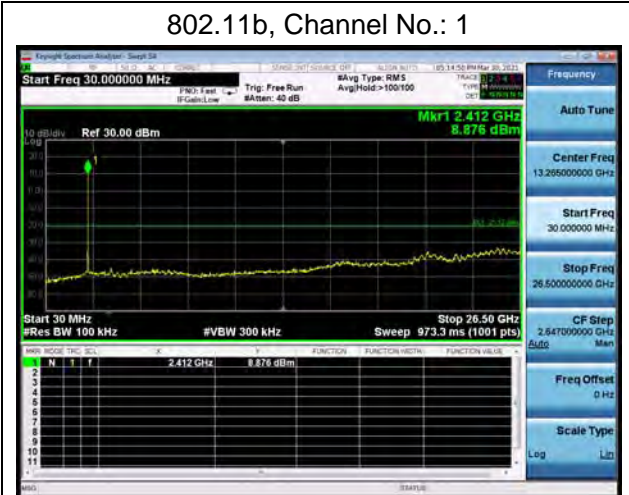



802.11b, Channel No.: 10

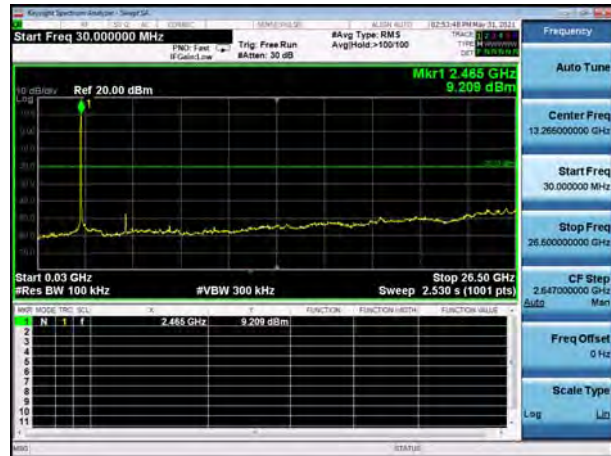

802.11g, Channel No.: 10

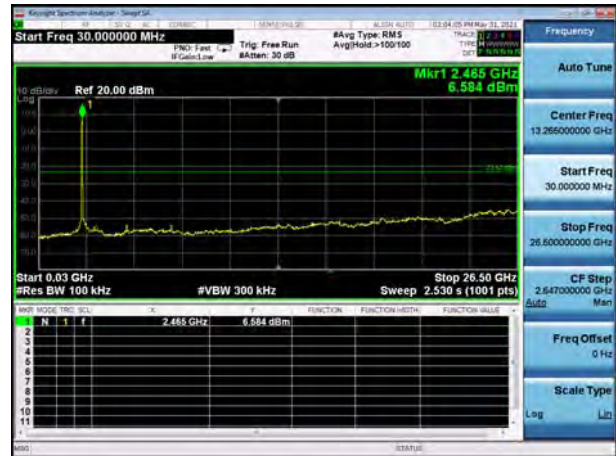

802.11b, Channel No.: 11

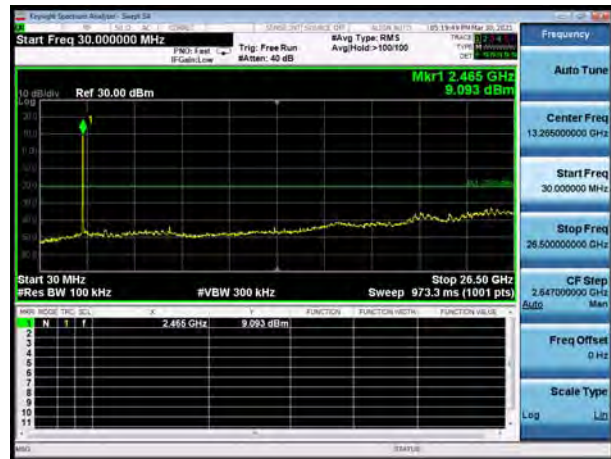

802.11g, Channel No.: 11

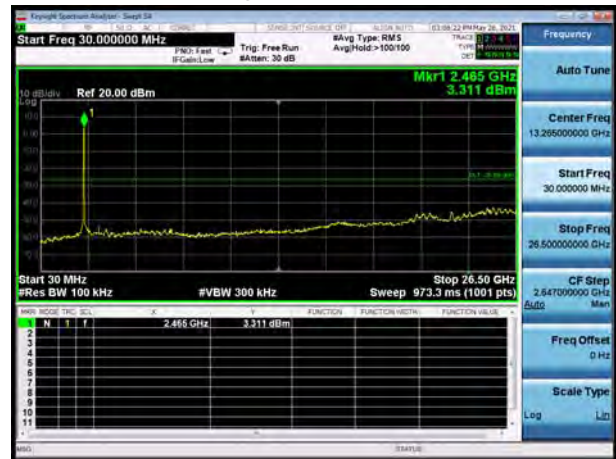

802.11n(HT20), Channel No. 1

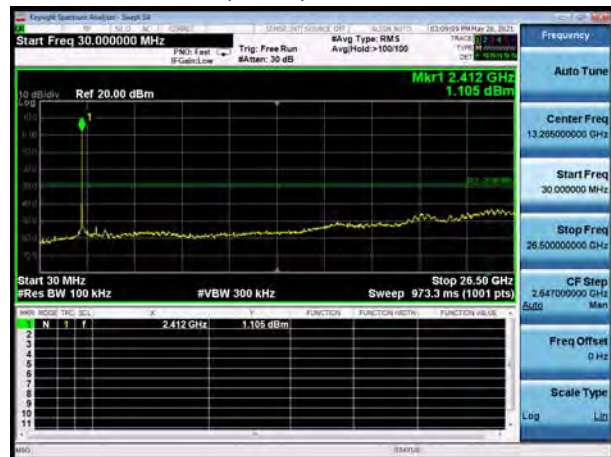

802.11n(HT40), Channel No. 3

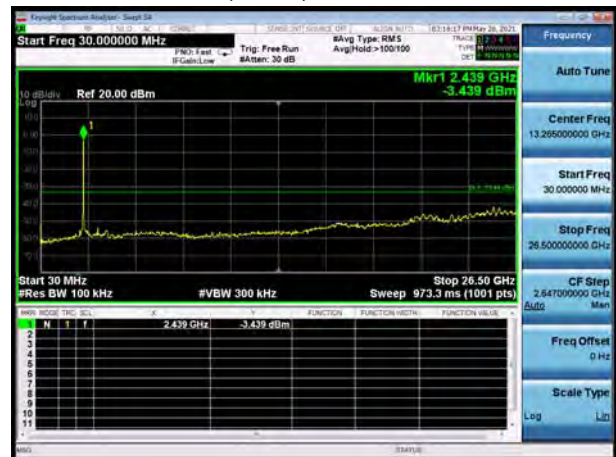



802.11n(HT20), Channel No. 2

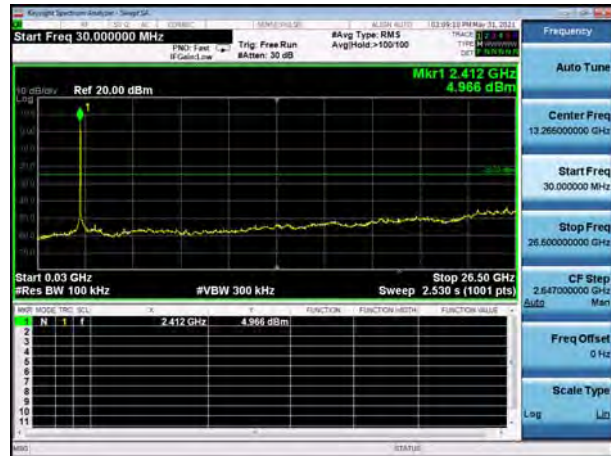

802.11n(HT40), Channel No. 4

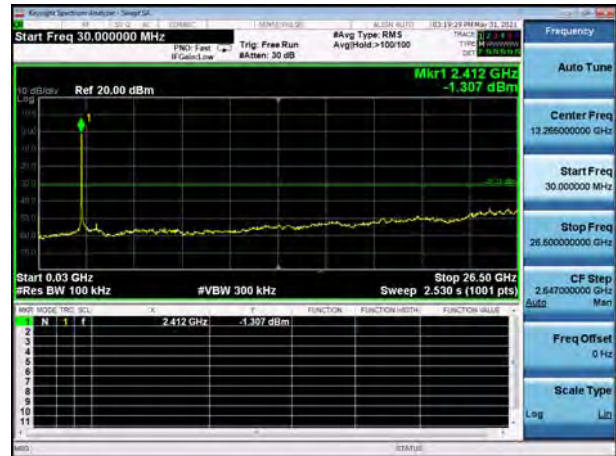

802.11n(HT20), Channel No. 6

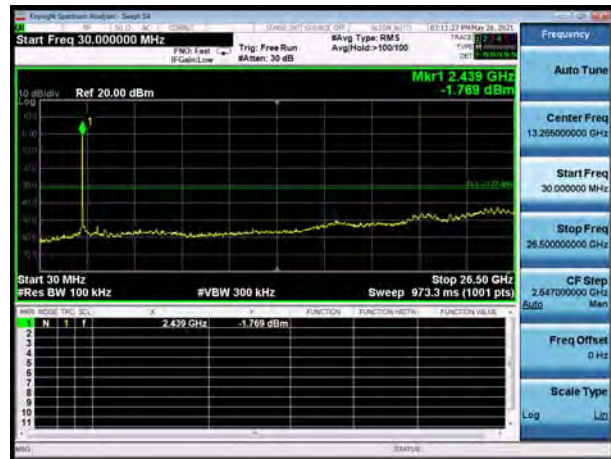

802.11n(HT40), Channel No. 5

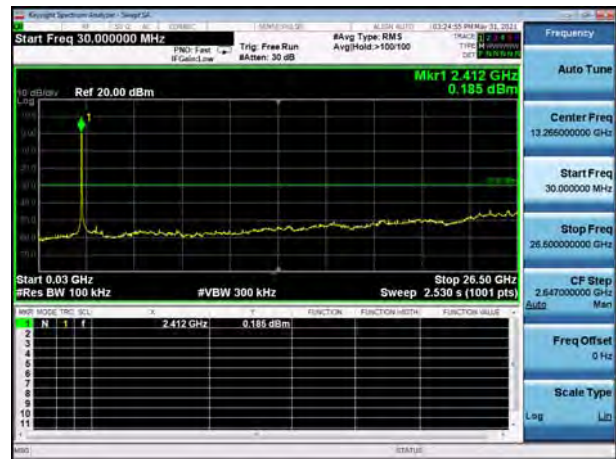

802.11n(HT20), Channel No. 10

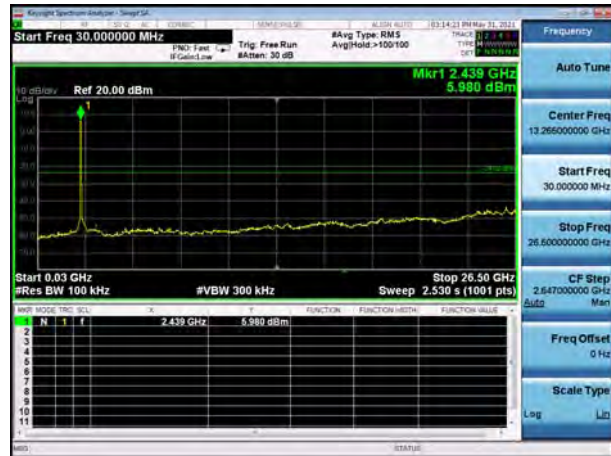

802.11n(HT40), Channel No. 6

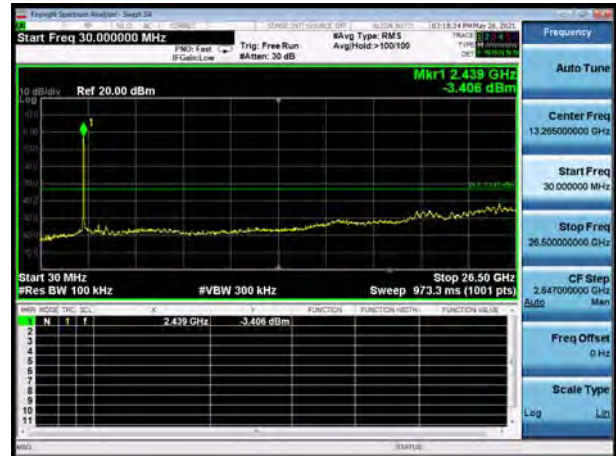



802.11n(HT20), Channel No. 11

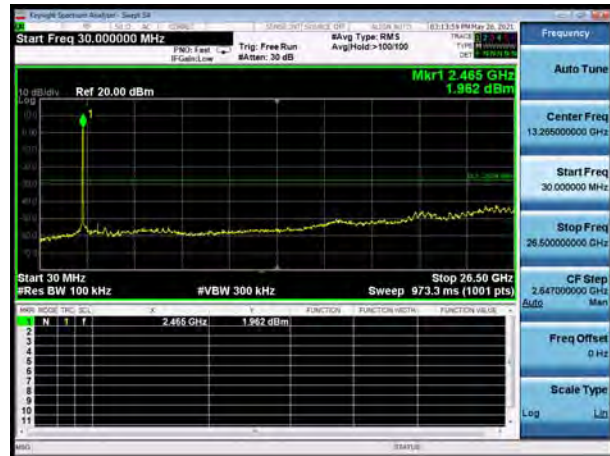

802.11n(HT40), Channel No. 7

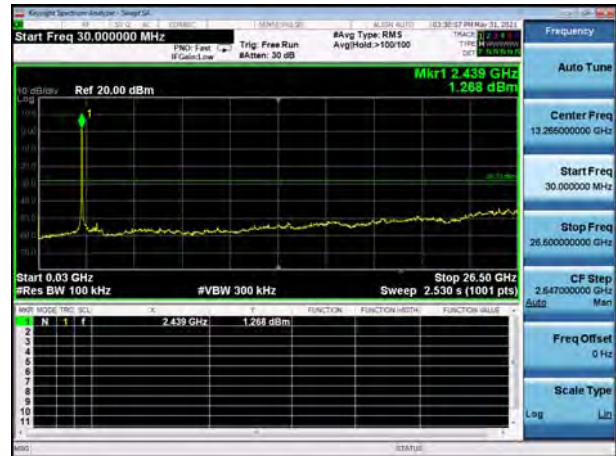

802.11n(HT40), Channel No. 8

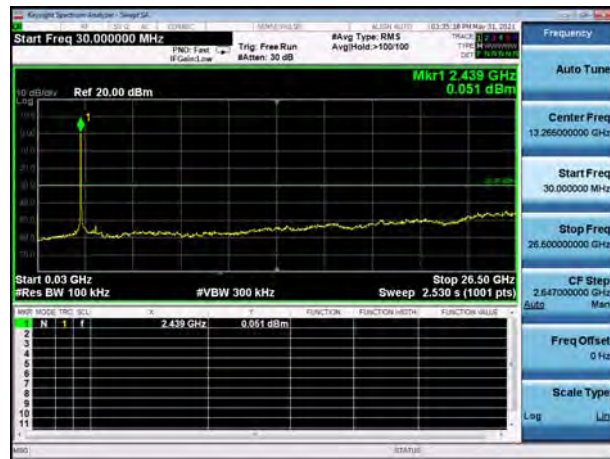

802.11n(HT40), Channel No. 9

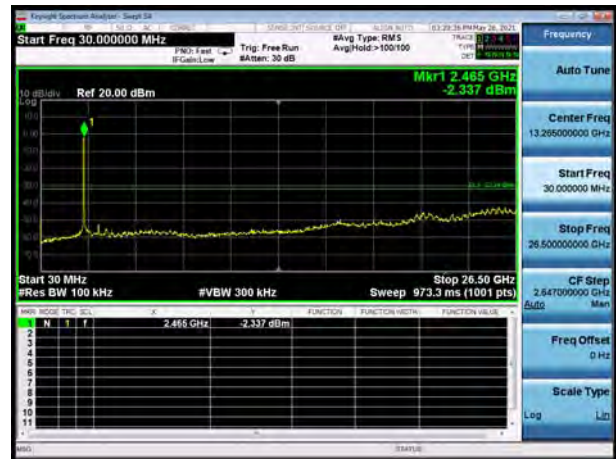



Bluetooth LE (1M), Channel No.: 0

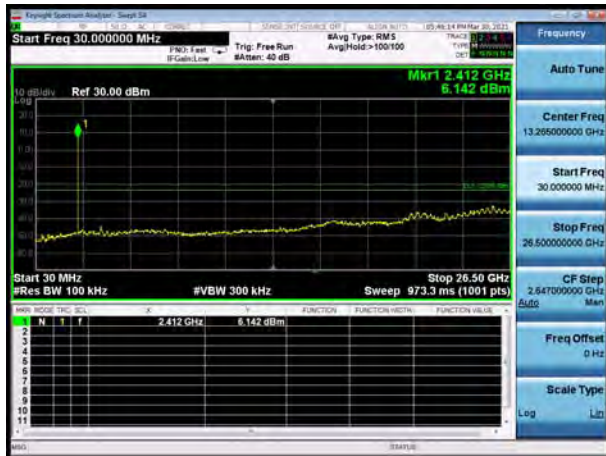

Bluetooth LE (2M), Channel No.: 0

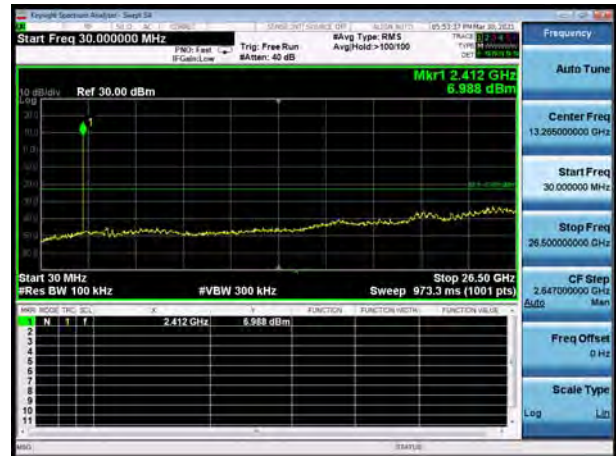

Bluetooth LE (1M), Channel No.: 19

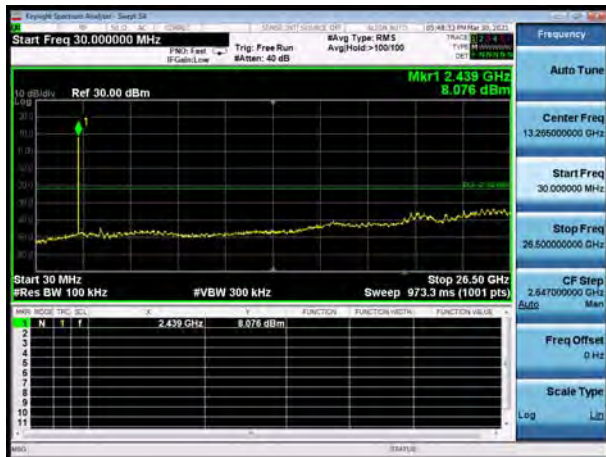

Bluetooth LE (2M), Channel No.: 19

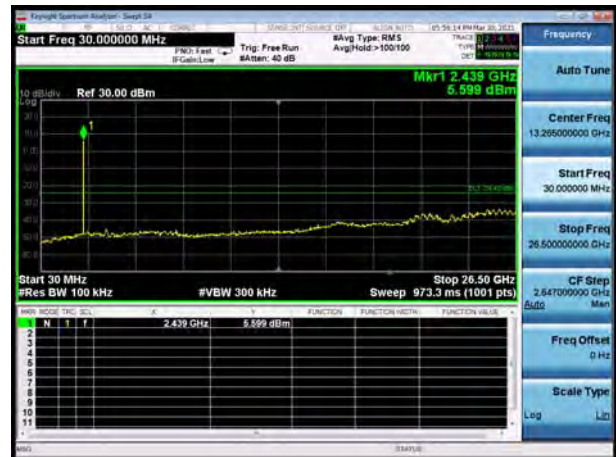

Bluetooth LE (1M), Channel No.: 39

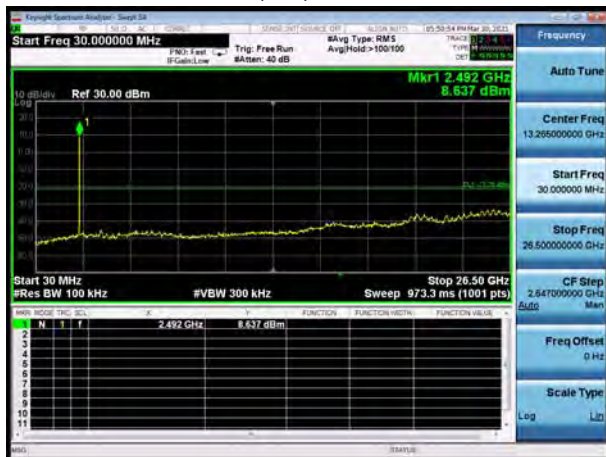

Bluetooth LE (2M), Channel No.: 39

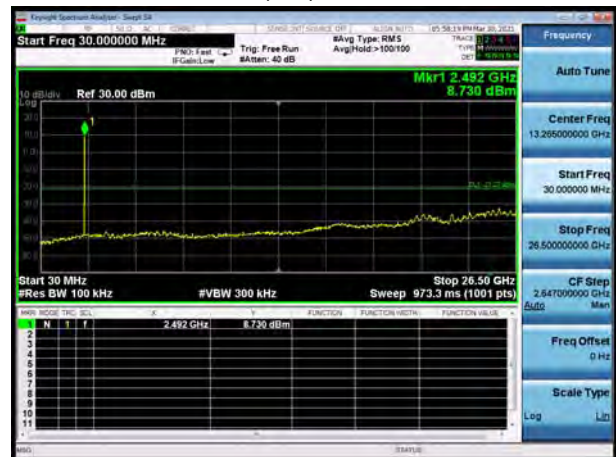

5.6. Unwanted Emission

Ambient condition

Temperature	Relative humidity	Pressure
23°C ~25°C	45%~50%	102.5kPa

Method of Measurement

The test set-up was made in accordance to the general provisions of ANSI C63.10.

The Equipment Under Test (EUT) was set up on a non-conductive table in the semi-anechoic chamber. The test was performed at the distance of 3 m between the EUT and the receiving antenna.

The turntable shall be rotated from 0 to 360 degrees for detecting the maximum of radiated spurious signal level. The measurements shall be repeated with orthogonal polarization of the test antenna. The data of cable loss and antenna factor has been calibrated in full testing frequency range before the testing. Sweep the Restricted Band and the emissions less than 20 dB below the permissible value are reported.

The radiated emissions measurements were made in a typical installation configuration.

Sweep the whole frequency band through the range from 9 kHz to the 10th harmonic of the carrier, and the emissions less than 20 dB below the permissible value are reported.

This method refer to ANSI C63.10.

The procedure for peak unwanted emissions measurements above 1000 MHz is as follows:

Set the spectrum analyzer in the following:

9kHz~150 kHz

RBW=200Hz, VBW=1kHz/ Sweep=AUTO

150 kHz~30MHz

RBW=9KHz, VBW=30KHz,/ Sweep=AUTO

Below 1GHz

RBW=100kHz / VBW=300kHz / Sweep=AUTO

a) Peak emission levels are measured by setting the instrument as follows:

Above 1GHz

PEAK: RBW=1MHz VBW=3MHz/ Sweep=AUTO

b) Average emission levels are measured by setting the instrument as follows:

Above 1GHz

AVERAGE: RBW=1MHz / VBW=3MHz / Sweep=AUTO

c) Detector: The measurements employing a CISPR quasi-peak detector except for the frequency bands 9-90 kHz, 110-490 kHz and above 1000 MHz. Radiated emission limits in these three bands are based on measurements employing an average detector.

d) Averaging type = power (i.e., rms) (As an alternative, the detector and averaging type may be set for linear voltage averaging. Some instruments require linear display mode to use linear voltage



averaging. Log or dB averaging shall not be used.)

e) Sweep time = auto.

f) Perform a trace average of at least 100 traces if the transmission is continuous. If the transmission is not continuous, then the number of traces shall be increased by a factor of $1 / D$, where D is the duty cycle. For example, with 50% duty cycle, at least 200 traces shall be averaged. (If a specific emission is demonstrated to be continuous—i.e., 100% duty cycle—then rather than turning ON and OFF with the transmit cycle, at least 100 traces shall be averaged.)

g) If tests are performed with the EUT transmitting at a duty cycle less than 98%, then a correction factor shall be added to the measurement results prior to comparing with the emission limit, to compute the emission level that would have been measured had the test been performed at 100% duty cycle. The correction factor is computed as follows:

1) If power averaging (rms) mode was used in the preceding step e), then the correction factor is $[10 \log (1 / D)]$, where D is the duty cycle. For example, if the transmit duty cycle was 50%, then 3 dB shall be added to the measured emission levels.

2) If linear voltage averaging mode was used in the preceding step e), then the correction factor is $[20 \log (1 / D)]$, where D is the duty cycle. For example, if the transmit duty cycle was 50%, then 6 dB shall be added to the measured emission levels.

3) If a specific emission is demonstrated to be continuous (100% duty cycle) rather than turning ON and OFF with the transmit cycle, then no duty cycle correction is required for that emission.

The test is in transmitting mode.

Test setup

9KHz ~ 30MHz

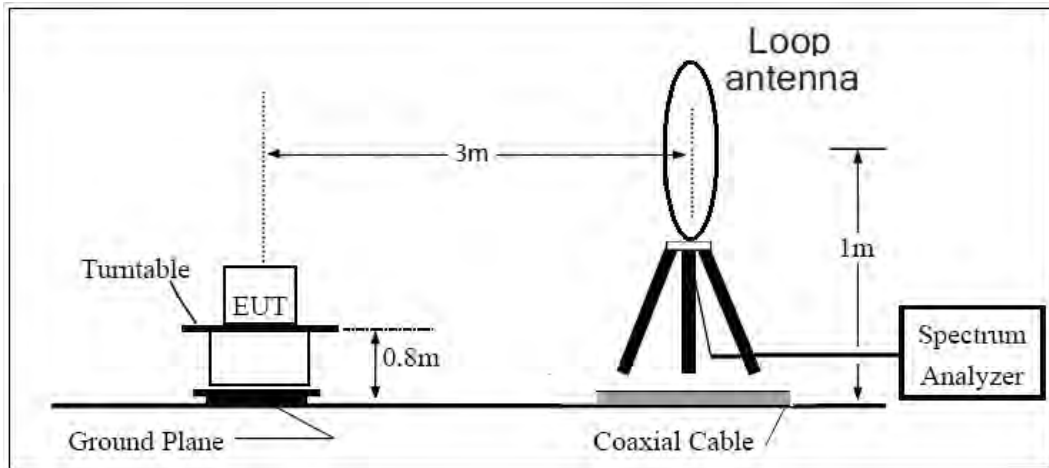

30MHz ~ 1GHz

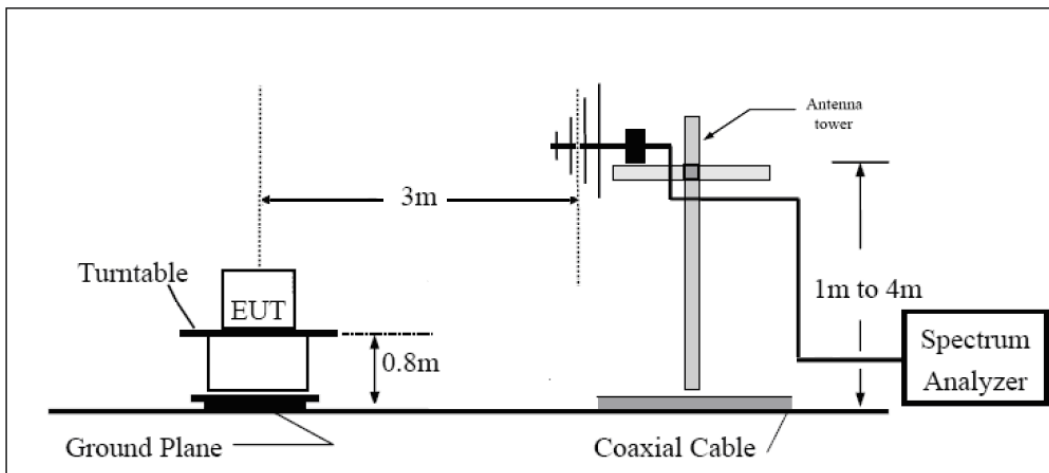

Above 1GHz

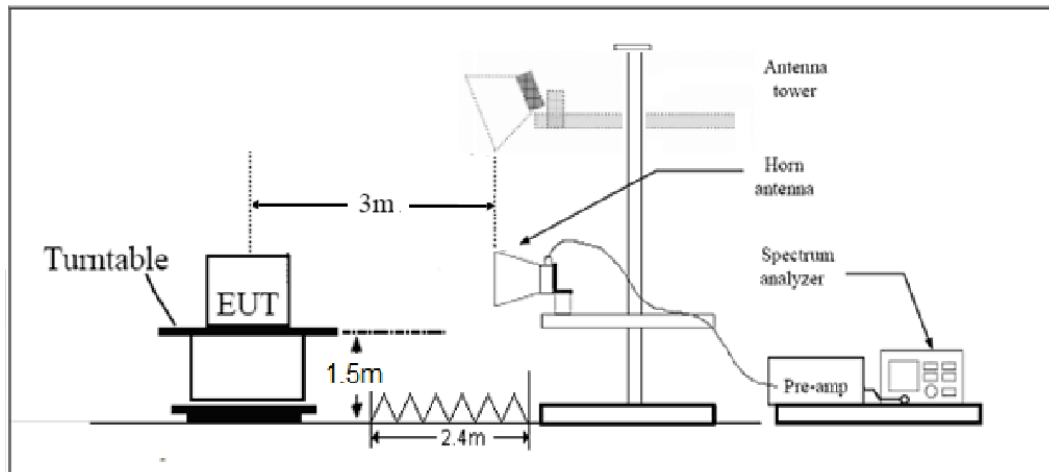

Note: Area side:2.4mX3.6m

**Limits**

Rule Part 15.247(d) specifies that "In addition, radiated emissions which fall in the restricted bands, as defined in § 15.205(a), must also comply with the radiated emission limits specified in § 15.209(a) (see § 15.205(c))."

Limit in restricted band

Frequency of emission (MHz)	Field strength(uV/m)	Field strength(dBuV/m)
0.009–0.490	2400/F(kHz)	/
0.490–1.705	24000/F(kHz)	/
1.705–30.0	30	/
30-88	100	40
88-216	150	43.5
216-960	200	46
Above960	500	54

§15.35(b)

There is also a limit on the radio frequency emissions, as measured using instrumentation with a peak detector function, corresponding to 20 dB above the maximum permitted average limit.

Peak Limit=74 dBuV/m

Average Limit=54 dBuV/m

Spurious Radiated Emissions are permitted in any of the frequency bands listed below:

MHz	MHz	MHz	GHz
0.090 - 0.110	16.42 - 16.423	399.9 - 410	4.5 - 5.15
¹ 0.495 - 0.505	16.69475 - 16.69525	608 - 614	5.35 - 5.46
2.1735 - 2.1905	16.80425 - 16.80475	960 - 1240	7.25 - 7.75
4.125 - 4.128	25.5 - 25.67	1300 - 1427	8.025 - 8.5
4.17725 - 4.17775	37.5 - 38.25	1435 - 1626.5	9.0 - 9.2
4.20725 - 4.20775	73 - 74.6	1645.5 - 1646.5	9.3 - 9.5
6.215 - 6.218	74.8 - 75.2	1660 - 1710	10.6 - 12.7
6.26775 - 6.26825	108 - 121.94	1718.8 - 1722.2	13.25 - 13.4
6.31175 - 6.31225	123 - 138	2200 - 2300	14.47 - 14.5
8.291 - 8.294	149.9 - 150.05	2310 - 2390	15.35 - 16.2
8.362 - 8.366	156.52475 - 156.52525	2483.5 - 2500	17.7 - 21.4
8.37625 - 8.38675	156.7 - 156.9	2690 - 2900	22.01 - 23.12
8.41425 - 8.41475	162.0125 - 167.17	3260 - 3267	23.6 - 24.0
12.29 - 12.293	167.72 - 173.2	3332 - 3339	31.2 - 31.8
12.51975 - 12.52025	240 - 285	3345.8 - 3358	36.43 - 36.5
12.57675 - 12.57725	322 - 335.4	3600 - 4400	(²)
13.36 - 13.41			

**Measurement Uncertainty**

The assessed measurement uncertainty to ensure 95% confidence level for the normal distribution is with the coverage factor $k = 1.96$.

Frequency	Uncertainty
9KHz-30MHz	3.55 dB
30MHz-200MHz	4.17 dB
200MHz-1GHz	4.84 dB
1-18GHz	4.35 dB
18-26.5GHz	5.90 dB
26.5GHz~40GHz	5.92 dB



Test Results:

A font (dB μ V/m)in the test plot =(dB μ V/m)

A font (dB V/)in the test plot =(dB μ V/m)

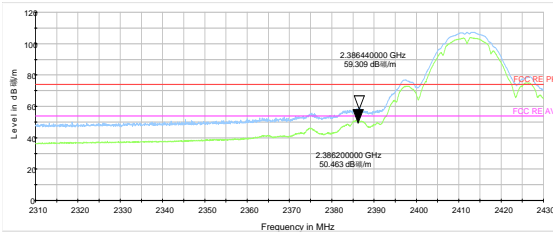

802.11b-Channel 1 Peak & Average

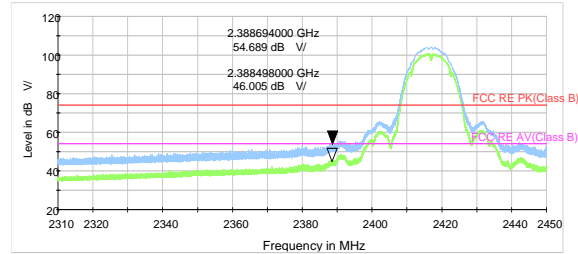

802.11b-Channel 2 Peak & Average

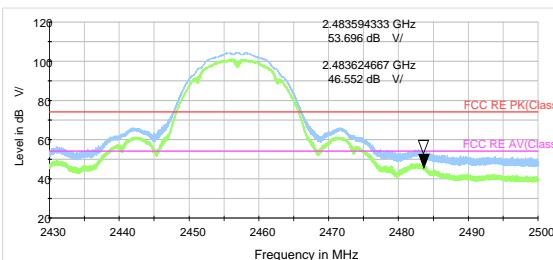

802.11b-Channel 10 Peak & Average

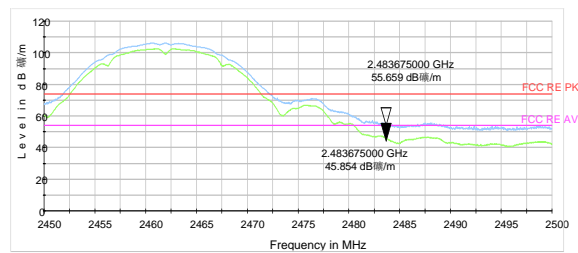

802.11b-Channel 11 Peak & Average

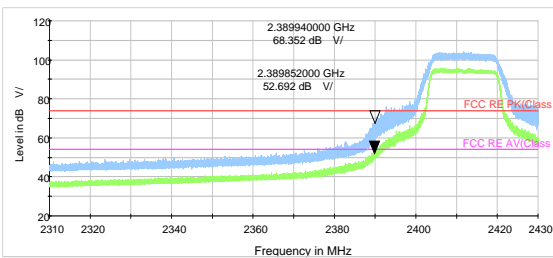

802.11g-Channel 1 Peak & Average

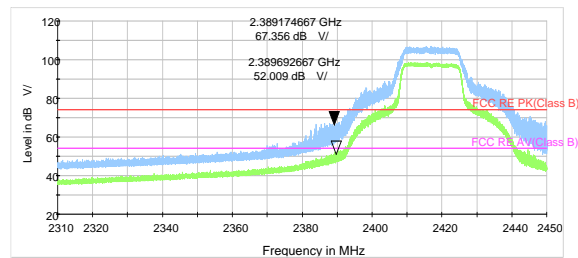

802.11g-Channel 2 Peak & Average

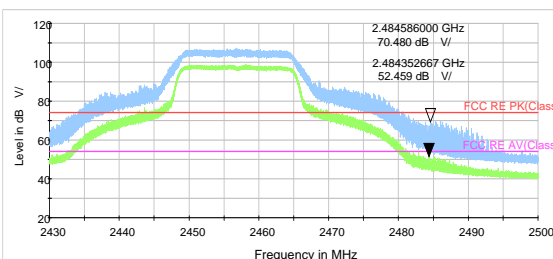

802.11g-Channel 10 Peak & Average

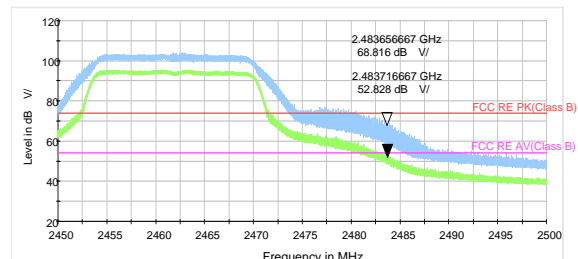

802.11g-Channel 11 Peak & Average

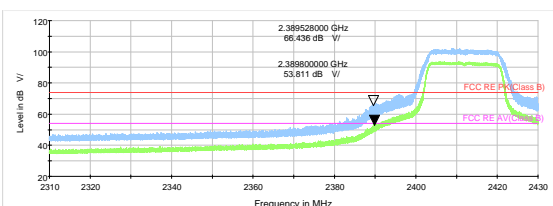

802.11n HT20 -Channel 1 Peak & Average

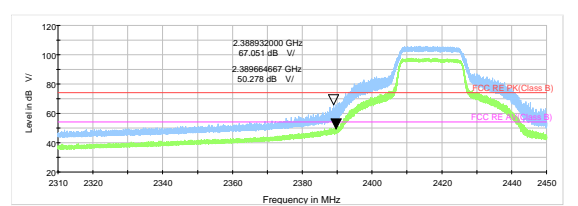

802.11n HT20 -Channel 2 Peak & Average

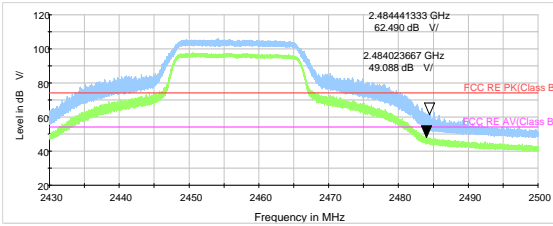

802.11n HT20 -Channel 10 Peak & Average

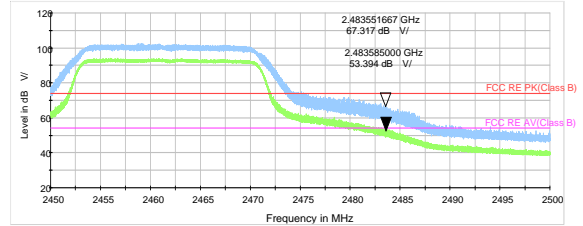

802.11n HT20 -Channel 11 Peak & Average

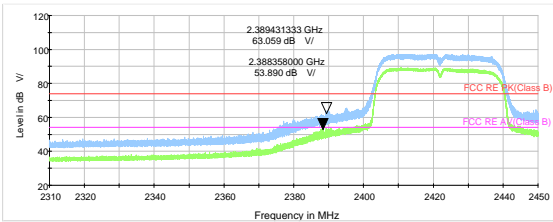

802.11n HT40 -Channel 3 Peak & Average

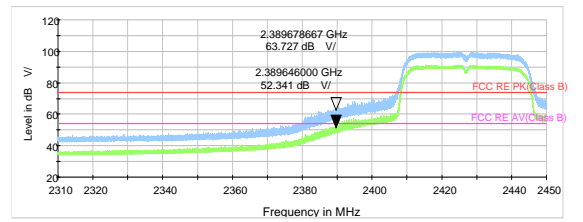

802.11n HT40 -Channel 4 Peak & Average

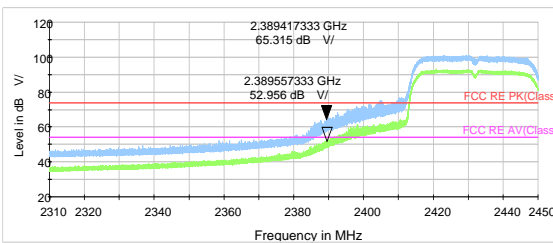

802.11n HT40 -Channel 5 Peak & Average

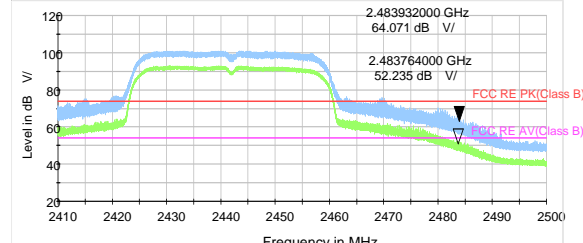

802.11n HT40 -Channel 7 Peak & Average

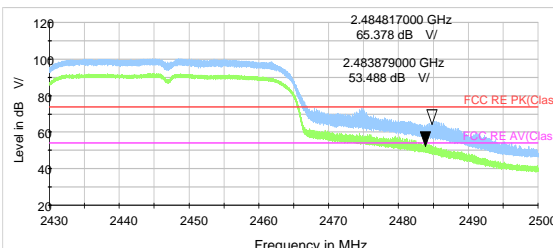

802.11n HT40 -Channel 8 Peak & Average

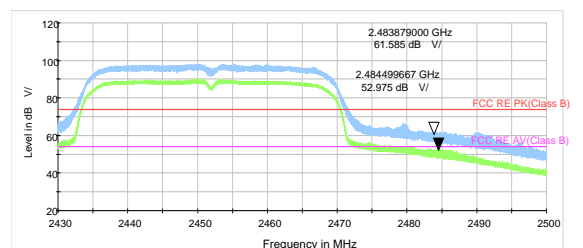

802.11n HT40 -Channel 9 Peak & Average



During the test, the preliminary test was performed in both data rate for BLE, 1Mbps was selected as the worst case. The test data of the worst-case condition was recorded in this report

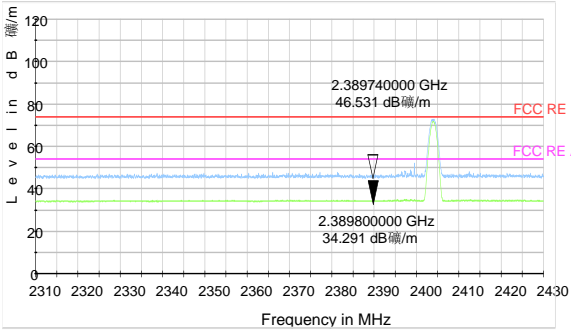

Bluetooth LE Channel 0 Peak & Average

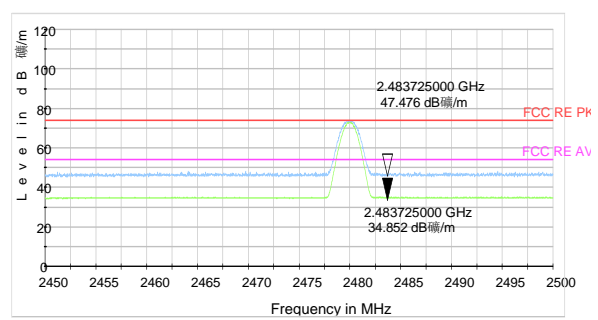

Bluetooth LE Channel 39 Peak & Average



Result of RE

Test result

Sweep the whole frequency band through the range from 9kHz to the 10th harmonic of the carrier, the Emissions in the frequency band 9kHz-30MHz are more than 20dB below the limit are not reported.

The following graphs display the maximum values of horizontal and vertical by software. For above 1GHz, Blue trace uses the peak detection, Green trace uses the average detection.

During the test, the Radiates Emission from 30MHz to 1GHz was performed in all modes with all channels, 802.11n (HT40) CH3 are selected as the worst condition. The test data of the worst-case condition was recorded in this report.

Continuous TX mode:

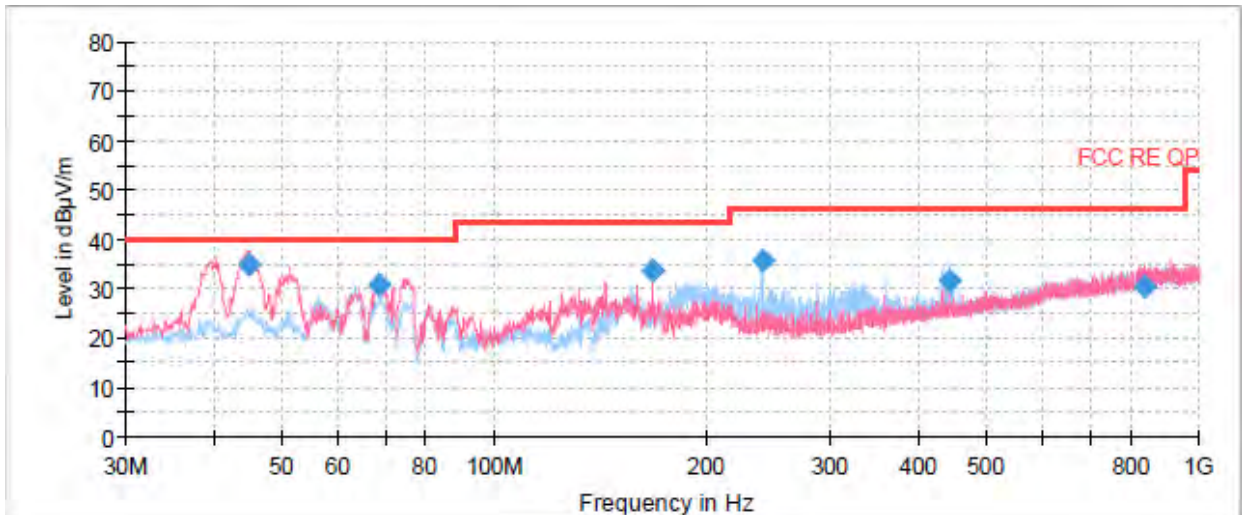

Radiates Emission from 30MHz to 1GHz

Frequency (MHz)	Quasi-Peak (dBuV/m)	Height (cm)	Polarization	Azimuth (deg)	Correct Factor (dB)	Margin (dB)	Limit (dBuV/m)
44.913750	34.81	100.0	V	90.0	14.1	5.19	40.00
68.921250	30.97	100.0	V	268.0	10.6	9.03	40.00
167.982500	33.55	100.0	V	198.0	10.0	9.95	43.50
240.005000	35.77	105.0	H	180.0	13.7	10.23	46.00
444.068750	31.74	100.0	H	26.0	18.4	14.26	46.00
839.828750	30.23	225.0	H	232.0	24.1	15.77	46.00

Remark: 1. Correction Factor = Antenna factor+ Insertion loss(cable loss+amplifier gain)
2. Margin = Limit – Quasi-Peak

802.11b CH1

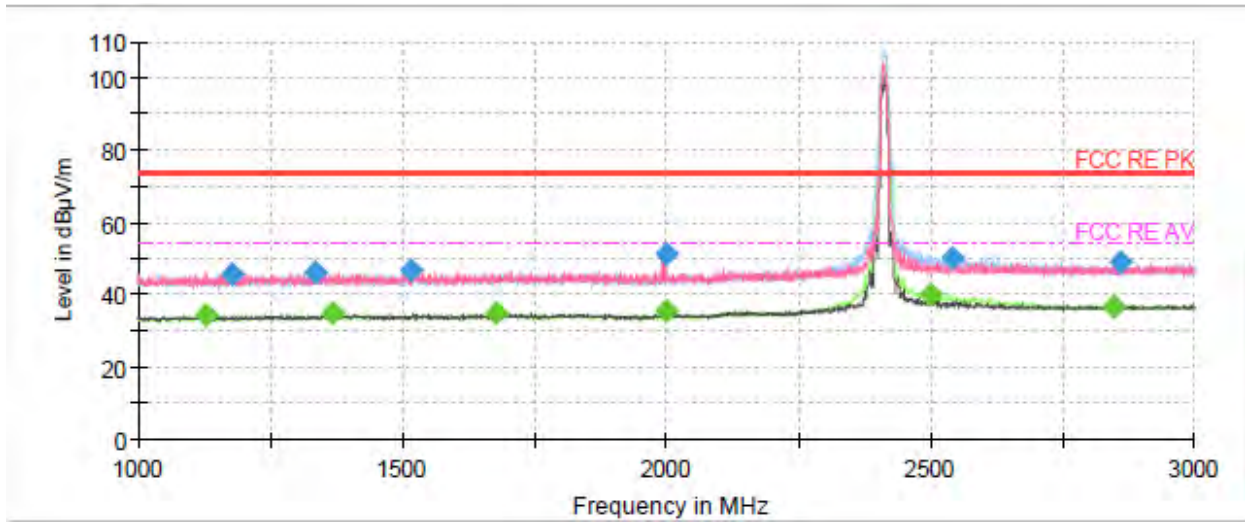

Note: The signal beyond the limit is carrier.

Radiates Emission from 1GHz to 3GHz

Frequency (MHz)	MaxPeak (dB µ V/m)	Average (dB µ V/m)	Limit (dB µ V/m)	Margin (dB)	Height (cm)	Pol	Azimuth (deg)	Corr. (dB/m)
1128.500000	---	34.28	54.00	19.72	200.0	V	12.0	-10.5
1176.500000	45.69	---	74.00	28.31	200.0	V	17.0	-10.4
1334.500000	46.32	---	74.00	27.68	200.0	V	70.0	-9.7
1369.500000	---	34.78	54.00	19.22	100.0	V	357.0	-9.6
1515.250000	46.54	---	74.00	27.46	200.0	H	241.0	-9.1
1676.250000	---	35.17	54.00	18.83	200.0	V	62.0	-8.7
1998.250000	---	35.57	54.00	18.43	200.0	V	207.0	-8.2
1998.250000	51.39	---	74.00	22.61	200.0	V	207.0	-8.2
2499.500000	---	40.18	54.00	13.82	100.0	H	14.0	-6.3
2539.750000	50.34	---	74.00	23.66	100.0	H	2.0	-6.2
2848.000000	---	36.82	54.00	17.18	100.0	H	67.0	-6.1
2859.500000	48.85	---	74.00	25.15	200.0	V	29.0	-6.0

Remark: 1. Correction Factor = Antenna factor+ Insertion loss (cable loss + amplifier gain)

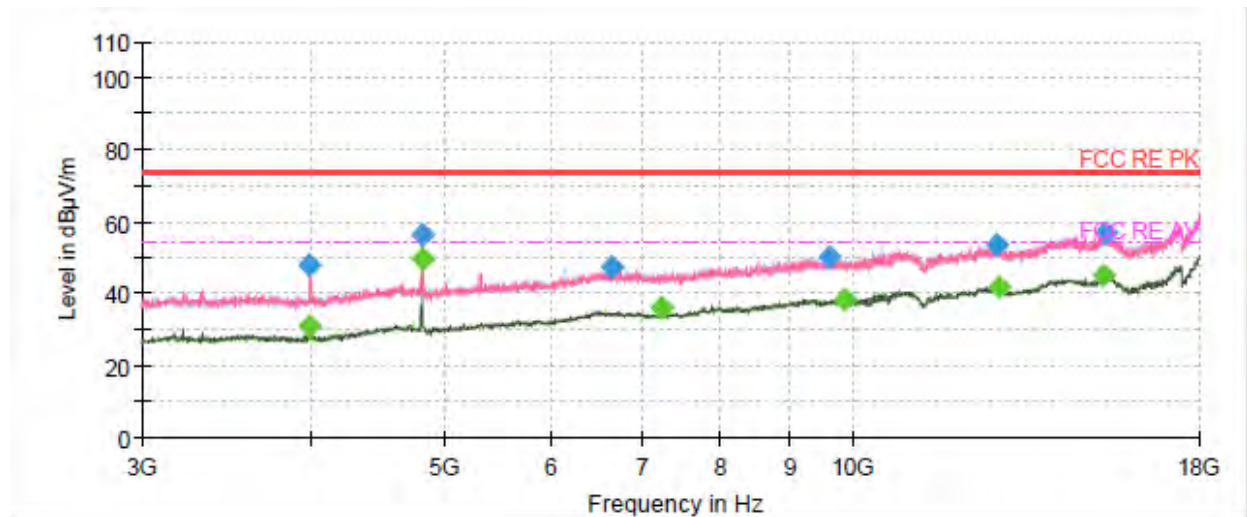

Radiates Emission from 3GHz to 18GHz

Frequency (MHz)	MaxPeak (dB μ V/m)	Average (dB μ V/m)	Limit (dB μ V/m)	Margin (dB)	Height (cm)	Pol	Azimuth (deg)	Corr. (dB/m)
3990.000000	48.05	---	74.00	25.95	100.0	H	227.0	-13.4
3991.875000	---	30.76	54.00	23.24	200.0	V	15.0	-13.3
4822.500000	56.13	---	74.00	17.87	200.0	V	354.0	-10.7
4822.500000	---	49.61	54.00	4.39	200.0	V	354.0	-10.7
6663.750000	47.26	---	74.00	26.74	100.0	V	250.0	-3.5
7233.750000	---	36.33	54.00	17.67	200.0	V	36.0	-4.6
9609.375000	49.94	---	74.00	24.06	200.0	V	92.0	-2.3
9853.125000	---	38.57	54.00	15.43	100.0	H	9.0	-1.8
12791.250000	53.31	---	74.00	20.69	200.0	H	226.0	2.1
12808.125000	---	41.55	54.00	12.45	100.0	H	150.0	2.1
15305.625000	---	44.93	54.00	9.07	100.0	H	13.0	5.7
15352.500000	57.08	---	74.00	16.92	200.0	H	150.0	5.8

Remark: 1. Correction Factor = Antenna factor+ Insertion loss (cable loss + amplifier gain)

802.11b CH2

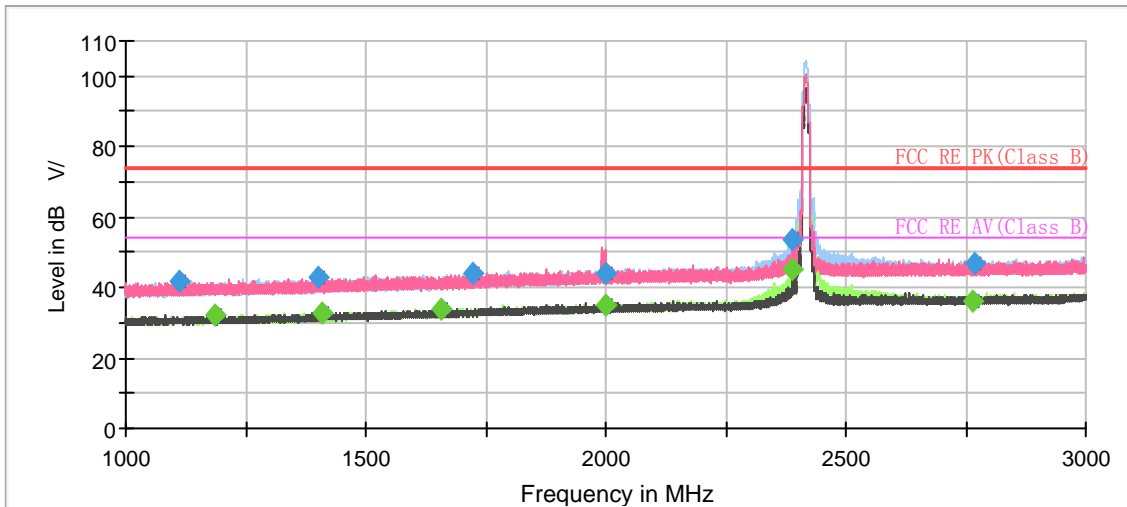

Note: The signal beyond the limit is carrier.
Radiates Emission from 1GHz to 3GHz

Frequency (MHz)	MaxPeak (dB μ V/m)	Average (dB μ V/m)	Limit (dB μ V/m)	Margin (dB)	Height (cm)	Pol	Azimuth (deg)	Corr. (dB/m)
1110.666667	41.82	---	74.00	32.18	100.0	V	168.0	-7.7
1186.000000	---	32.09	54.00	21.91	200.0	V	181.0	-7.4
1400.933333	42.75	---	74.00	31.25	100.0	V	333.0	-6.2
1410.400000	---	32.70	54.00	21.30	200.0	H	31.0	-6.1
1658.000000	---	33.97	54.00	20.03	200.0	H	292.0	-4.7
1724.133333	44.20	---	74.00	29.80	100.0	V	233.0	-4.3
1998.800000	---	34.95	54.00	19.05	200.0	H	268.0	-2.7
2000.866667	43.87	---	74.00	30.13	200.0	H	39.0	-2.6
2388.800000	---	45.17	54.00	8.83	200.0	H	180.0	-1.2
2389.333333	53.41	---	74.00	20.59	200.0	H	180.0	-1.2
2762.666667	---	36.15	54.00	17.85	200.0	H	348.0	0.8
2767.066667	46.76	---	74.00	27.24	200.0	H	0.0	0.8

Remark: 1. Correction Factor = Antenna factor+ Insertion loss (cable loss + amplifier gain)

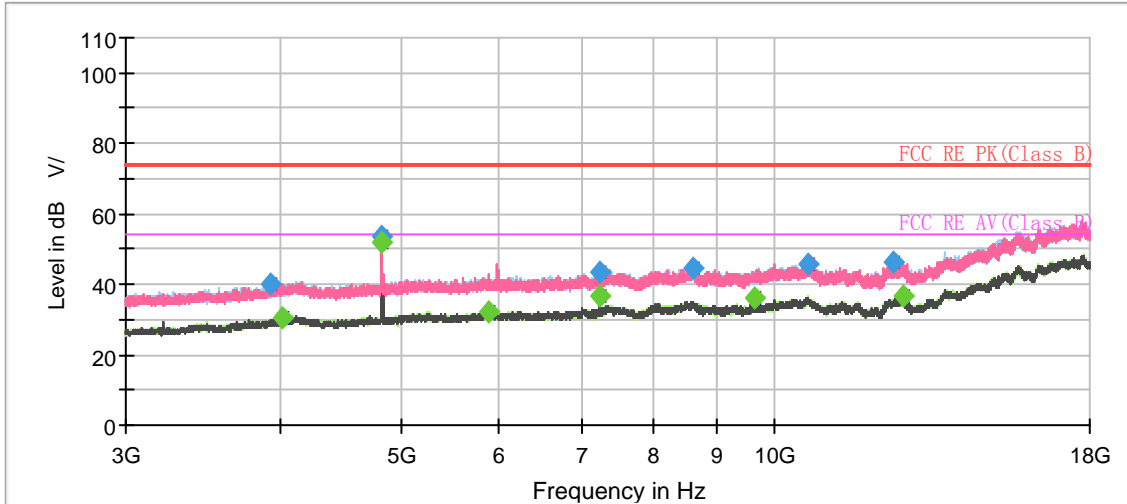

Radiates Emission from 3GHz to 18GHz

Frequency (MHz)	MaxPeak (dB μ V/m)	Average (dB μ V/m)	Limit (dB μ V/m)	Margin (dB)	Height (cm)	Pol	Azimuth (deg)	Corr. (dB/m)
3924.500000	40.30	---	74.00	33.70	100.0	V	0.0	-4.4
4021.000000	---	30.19	54.00	23.81	200.0	H	7.0	-3.7
4833.500000	---	51.84	54.00	2.16	200.0	V	153.0	-2.3
4834.000000	53.43	---	74.00	20.57	200.0	V	153.0	-2.3
5893.500000	---	32.18	54.00	21.82	100.0	V	32.0	-0.3
7250.500000	---	36.52	54.00	17.48	100.0	H	291.0	1.3
7251.500000	43.71	---	74.00	30.29	100.0	H	0.0	1.3
8616.500000	44.71	---	74.00	29.29	100.0	H	299.0	3.9
9668.000000	---	36.19	54.00	17.81	200.0	V	259.0	4.0
10655.000000	45.57	---	74.00	28.43	100.0	V	131.0	5.4
12484.500000	46.24	---	74.00	27.76	100.0	V	58.0	7.0
12715.500000	---	36.79	54.00	17.21	100.0	V	318.0	7.5

Remark: 1. Correction Factor = Antenna factor+ Insertion loss (cable loss + amplifier gain)

802.11b CH6

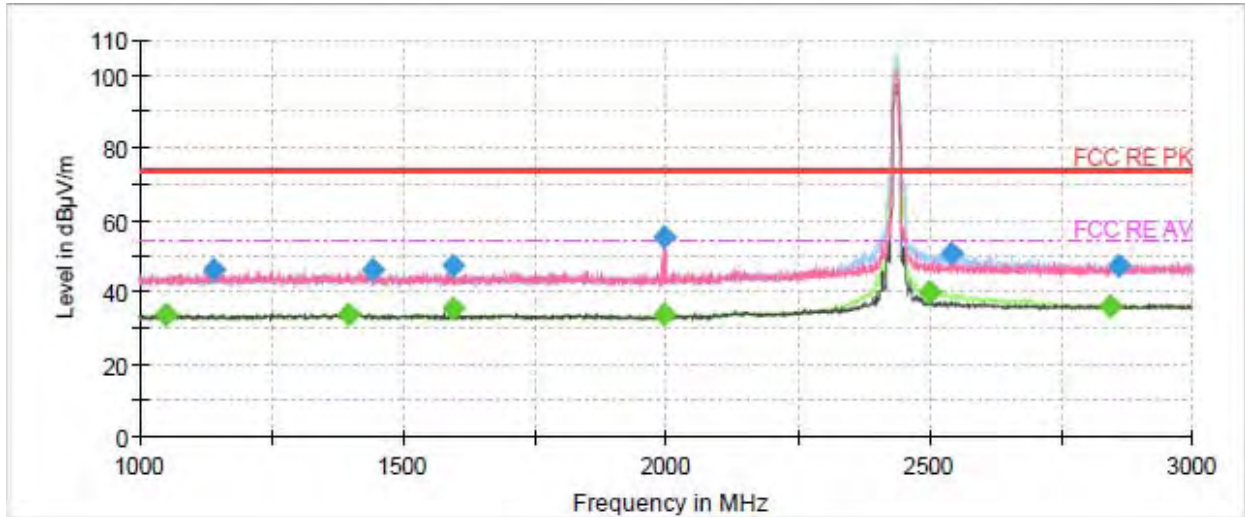

Note: The signal beyond the limit is carrier.
Radiates Emission from 1GHz to 3GHz

Frequency (MHz)	MaxPeak (dB µ V/m)	Average (dB µ V/m)	Limit (dB µ V/m)	Margin (dB)	Height (cm)	Pol	Azimuth (deg)	Corr. (dB/m)
1049.000000	---	33.96	54.00	20.04	200.0	V	9.0	-11.0
1140.750000	46.39	---	74.00	27.61	200.0	V	164.0	-10.5
1394.750000	---	33.94	54.00	20.06	100.0	V	356.0	-9.6
1440.750000	46.03	---	74.00	27.97	200.0	H	307.0	-9.3
1595.750000	---	35.57	54.00	18.43	200.0	V	3.0	-8.9
1595.750000	47.57	---	74.00	26.43	200.0	V	3.0	-8.9
1997.250000	---	33.94	54.00	20.06	200.0	V	267.0	-8.2
1997.250000	55.44	---	74.00	18.56	200.0	V	267.0	-8.2
2498.250000	---	40.30	54.00	13.70	200.0	H	0.0	-6.3
2539.500000	50.70	---	74.00	23.30	200.0	H	355.0	-6.2
2842.000000	---	35.99	54.00	18.01	200.0	H	237.0	-6.1
2860.500000	47.44	---	74.00	26.56	100.0	H	0.0	-6.0

Remark: 1. Correction Factor = Antenna factor+ Insertion loss (cable loss + amplifier gain)

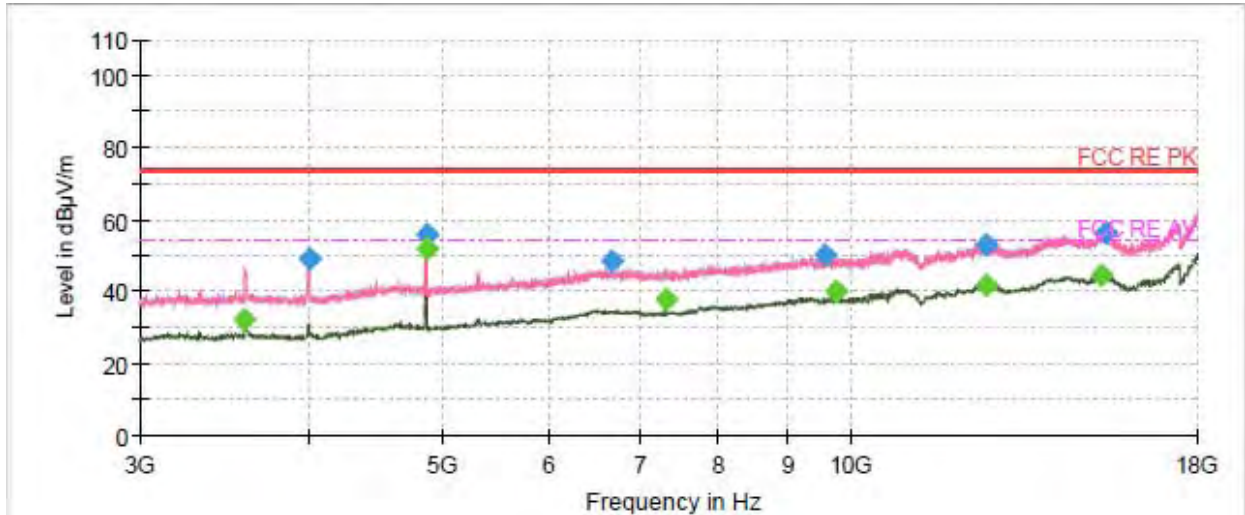

Radiates Emission from 3GHz to 18GHz

Frequency (MHz)	MaxPeak (dB µ V/m)	Average (dB µ V/m)	Limit (dB µ V/m)	Margin (dB)	Height (cm)	Pol	Azimuth (deg)	Corr. (dB/m)
3586.875000	---	31.89	54.00	22.11	100.0	V	264.0	-14.4
3993.750000	49.01	---	74.00	24.99	100.0	V	312.0	-13.3
4873.125000	55.86	---	74.00	18.14	200.0	V	346.0	-10.7
4873.125000	---	52.05	54.00	1.95	200.0	V	346.0	-10.7
6673.125000	48.31	---	74.00	25.69	100.0	V	303.0	-3.5
7308.750000	---	37.92	54.00	16.08	100.0	H	230.0	-4.4
9585.000000	50.01	---	74.00	23.99	100.0	V	358.0	-2.4
9748.125000	---	39.80	54.00	14.20	100.0	V	274.0	-2.4
12571.875000	53.22	---	74.00	20.78	100.0	V	178.0	2.1
12573.750000	---	41.98	54.00	12.02	200.0	H	358.0	2.1
15328.125000	---	44.71	54.00	9.29	200.0	V	12.0	5.7
15401.250000	56.67	---	74.00	17.33	200.0	V	161.0	5.6

Remark: 1. Correction Factor = Antenna factor+ Insertion loss (cable loss + amplifier gain)

802.11b CH10

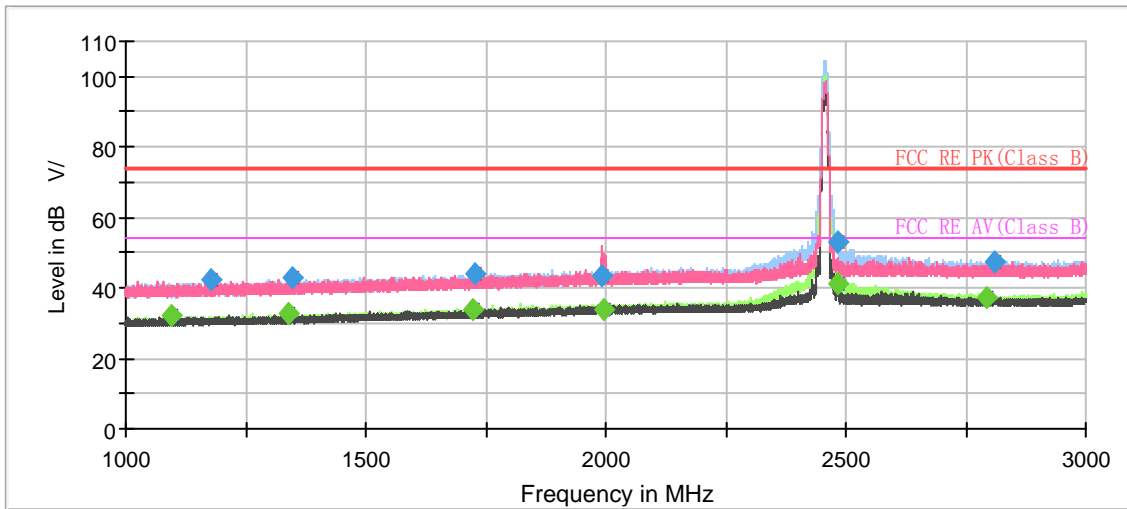

Note: The signal beyond the limit is carrier.

Radiates Emission from 1GHz to 3GHz

Frequency (MHz)	MaxPeak (dB μ V/m)	Average (dB μ V/m)	Limit (dB μ V/m)	Margin (dB)	Height (cm)	Pol	Azimuth (deg)	Corr. (dB/m)
1093.533333	---	32.26	54.00	21.74	100.0	H	141.0	-7.8
1176.533333	42.09	---	74.00	31.91	100.0	H	53.0	-7.4
1339.666667	---	32.61	54.00	21.39	100.0	H	214.0	-6.6
1346.000000	42.78	---	74.00	31.22	200.0	H	294.0	-6.5
1722.333333	---	33.82	54.00	20.18	200.0	H	254.0	-4.3
1726.800000	44.03	---	74.00	29.97	100.0	H	117.0	-4.3
1993.533333	43.45	---	74.00	30.55	200.0	H	0.0	-2.7
1997.000000	---	34.12	54.00	19.88	200.0	H	317.0	-2.7
2483.866667	---	41.34	54.00	12.66	100.0	V	122.0	-0.7
2484.000000	52.96	---	74.00	21.04	100.0	H	173.0	-0.7
2792.800000	---	37.40	54.00	16.60	100.0	H	149.0	0.9
2810.400000	47.52	---	74.00	26.48	100.0	H	0.0	1.0

Remark: 1. Correction Factor = Antenna factor+ Insertion loss (cable loss + amplifier gain)

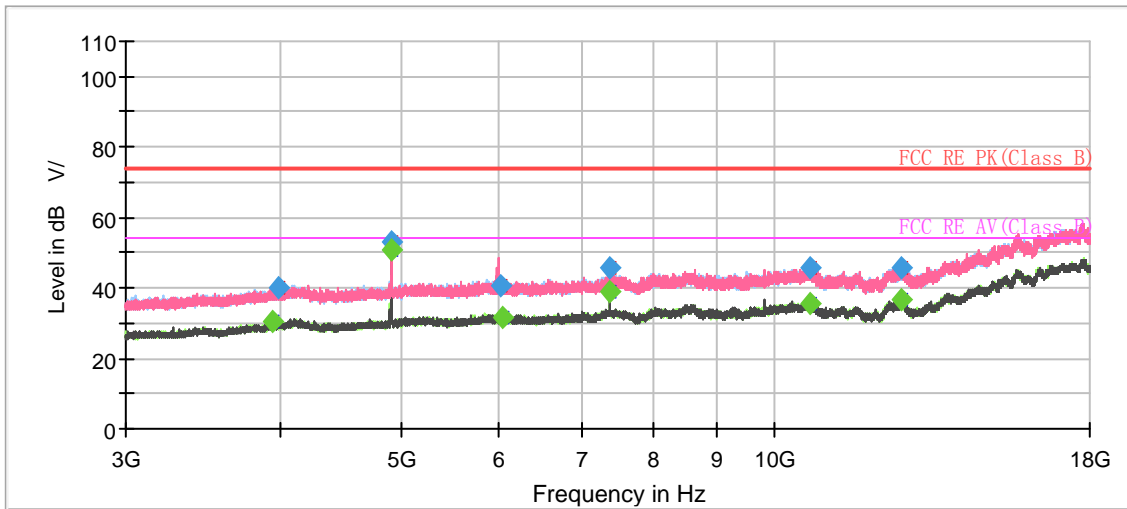

Radiates Emission from 3GHz to 18GHz

Frequency (MHz)	MaxPeak (dB μ V/m)	Average (dB μ V/m)	Limit (dB μ V/m)	Margin (dB)	Height (cm)	Pol	Azimuth (deg)	Corr. (dB/m)
3938.500000	---	30.20	54.00	23.80	200.0	V	33.0	-4.3
3986.500000	39.83	---	74.00	34.17	200.0	V	0.0	-3.9
4913.500000	52.77	---	74.00	21.23	100.0	H	33.0	-1.8
4913.500000	---	50.74	54.00	3.26	100.0	H	33.0	-1.8
6022.000000	40.75	---	74.00	33.25	100.0	H	211.0	-0.3
6035.500000	---	31.73	54.00	22.27	200.0	H	61.0	-0.4
7370.000000	---	38.80	54.00	15.20	100.0	H	0.0	1.5
7370.000000	45.71	---	74.00	28.29	100.0	H	0.0	1.5
10702.000000	45.42	---	74.00	28.58	100.0	V	36.0	5.3
10706.000000	---	35.66	54.00	18.34	200.0	V	203.0	5.3
12685.500000	45.69	---	74.00	28.31	100.0	H	0.0	7.5
12698.000000	---	36.49	54.00	17.51	200.0	V	87.0	7.5

Remark: 1. Correction Factor = Antenna factor+ Insertion loss (cable loss + amplifier gain)

802.11b CH11

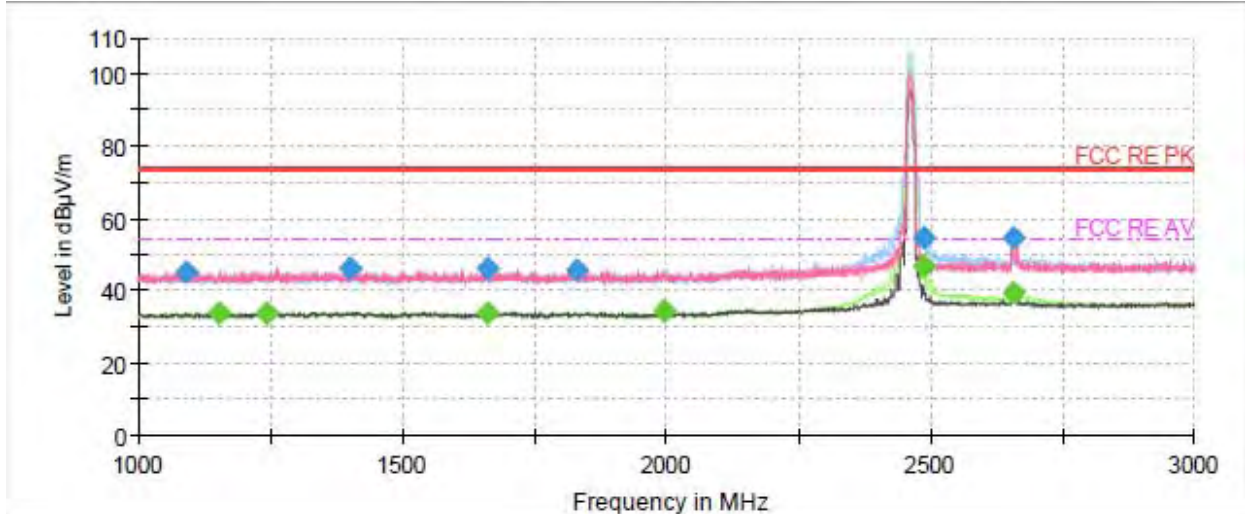

Note: The signal beyond the limit is carrier.
Radiates Emission from 1GHz to 3GHz

Frequency (MHz)	MaxPeak (dB µ V/m)	Average (dB µ V/m)	Limit (dB µ V/m)	Margin (dB)	Height (cm)	Pol	Azimuth (deg)	Corr. (dB/m)
1090.000000	45.08	---	74.00	28.92	200.0	V	0.0	-10.7
1153.250000	---	33.89	54.00	20.11	200.0	V	2.0	-10.4
1244.500000	---	34.03	54.00	19.97	100.0	V	230.0	-10.0
1402.000000	46.20	---	74.00	27.80	100.0	V	255.0	-9.5
1659.250000	---	34.11	54.00	19.89	100.0	H	273.0	-8.8
1660.500000	46.48	---	74.00	27.52	200.0	V	33.0	-8.8
1831.250000	45.93	---	74.00	28.07	200.0	H	277.0	-8.5
1995.500000	---	34.18	54.00	19.82	100.0	V	332.0	-8.2
2487.750000	54.69	---	74.00	19.31	200.0	H	14.0	-6.3
2488.000000	---	47.04	54.00	6.96	200.0	H	6.0	-6.3
2655.500000	---	39.36	54.00	14.64	200.0	V	180.0	-6.1
2655.750000	54.74	---	74.00	19.26	100.0	V	297.0	-6.1

Remark: 1. Correction Factor = Antenna factor+ Insertion loss (cable loss + amplifier gain)

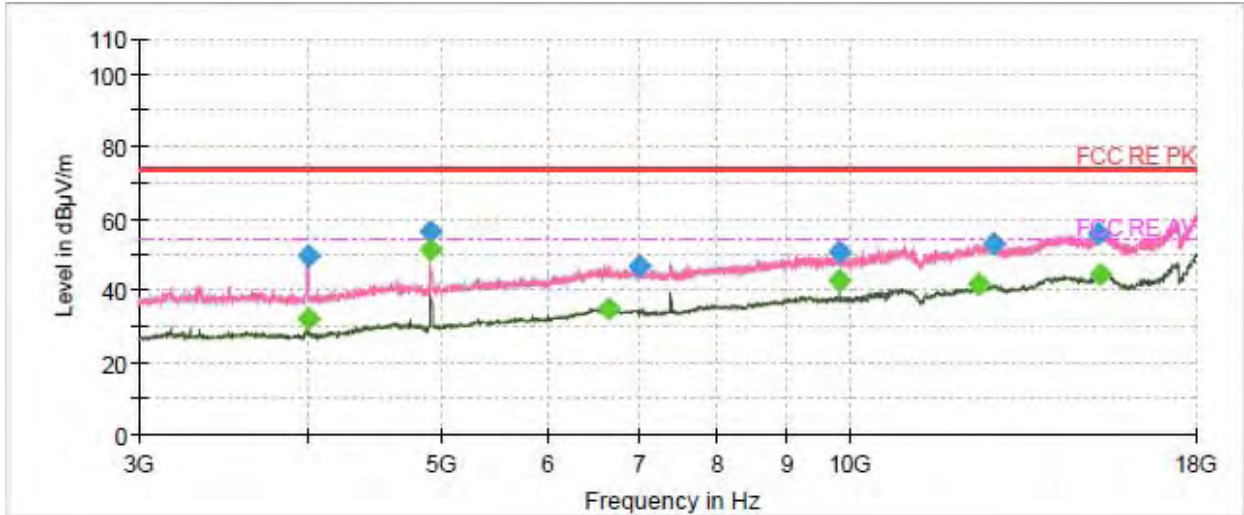

Radiates Emission from 3GHz to 18GHz

Frequency (MHz)	MaxPeak (dB µ V/m)	Average (dB µ V/m)	Limit (dB µ V/m)	Margin (dB)	Height (cm)	Pol	Azimuth (deg)	Corr. (dB/m)
3995.625000	49.60	---	74.00	24.40	100.0	H	237.0	-13.3
3997.500000	---	32.26	54.00	21.74	100.0	V	71.0	-13.3
4923.750000	56.68	---	74.00	17.32	200.0	V	22.0	-10.6
4923.750000	---	51.37	54.00	2.63	200.0	V	22.0	-10.6
6654.375000	---	35.08	54.00	18.92	100.0	V	71.0	-3.5
7006.875000	46.83	---	74.00	27.17	100.0	V	258.0	-3.9
9847.500000	---	42.98	54.00	11.02	200.0	V	86.0	-1.8
9847.500000	50.56	---	74.00	23.44	100.0	V	81.0	-1.8
12431.250000	---	41.79	54.00	12.21	100.0	H	159.0	1.6
12776.250000	53.08	---	74.00	20.92	100.0	V	186.0	2.2
15228.750000	55.84	---	74.00	18.16	200.0	H	110.0	5.4
15328.125000	---	44.77	54.00	9.23	200.0	H	178.0	5.7

Remark: 1. Correction Factor = Antenna factor+ Insertion loss (cable loss + amplifier gain)



802.11g CH1

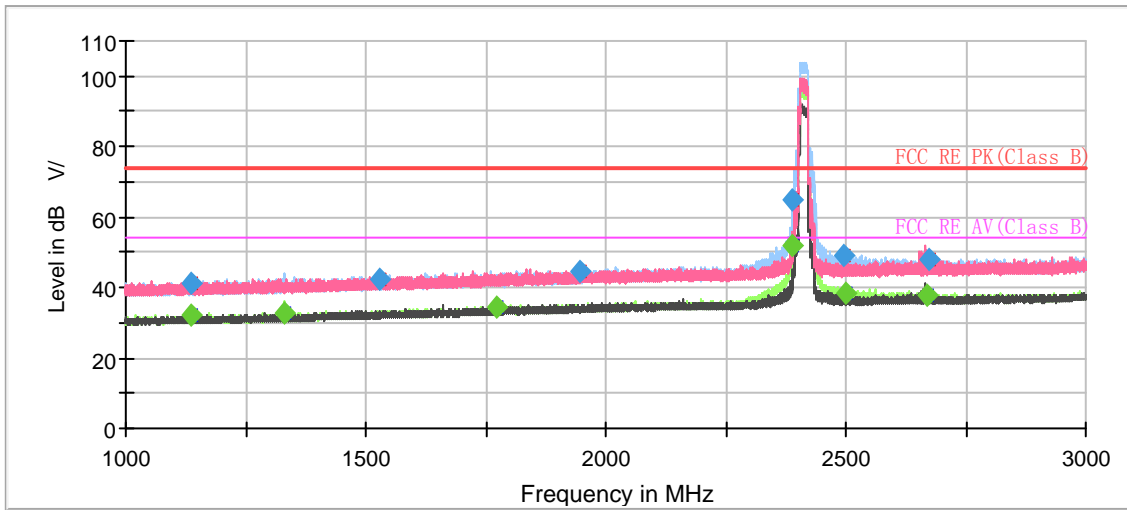

Note: The signal beyond the limit is carrier.

Radiates Emission from 1GHz to 3GHz

Frequency (MHz)	MaxPeak (dB μ V/m)	Average (dB μ V/m)	Limit (dB μ V/m)	Margin (dB)	Height (cm)	Pol	Azimuth (deg)	Corr. (dB/m)
1137.133333	---	32.04	54.00	21.96	200.0	H	27.0	-7.6
1137.266667	41.31	---	74.00	32.69	200.0	V	357.0	-7.6
1330.666667	---	32.50	54.00	21.50	200.0	H	91.0	-6.6
1529.066667	42.36	---	74.00	31.64	100.0	H	298.0	-5.4
1774.066667	---	34.54	54.00	19.46	100.0	V	148.0	-4.0
1947.400000	44.47	---	74.00	29.53	200.0	H	83.0	-3.0
2389.000000	---	51.72	54.00	2.28	200.0	H	298.0	-1.2
2389.000000	64.81	---	74.00	9.19	200.0	H	298.0	-1.2
2494.533333	48.99	---	74.00	25.01	200.0	H	159.0	-0.7
2500.933333	---	38.56	54.00	15.44	100.0	H	290.0	-0.6
2668.533333	---	37.57	54.00	16.43	100.0	H	0.0	0.4
2674.466667	47.73	---	74.00	26.27	100.0	H	71.0	0.5

Remark: 1. Correction Factor = Antenna factor+ Insertion loss (cable loss + amplifier gain)

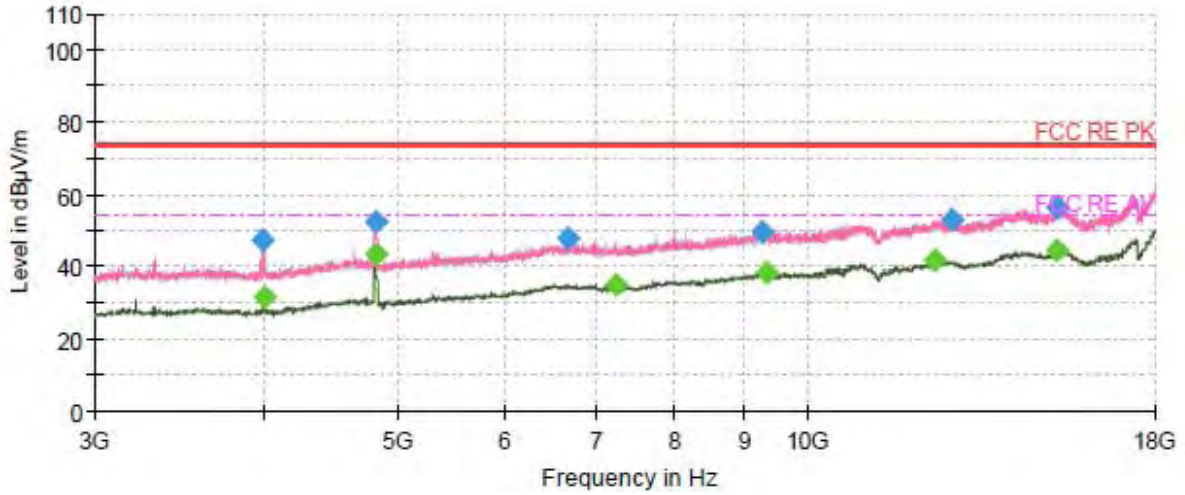

Radiates Emission from 3GHz to 18GHz

Frequency (MHz)	MaxPeak (dB µ V/m)	Average (dB µ V/m)	Limit (dB µ V/m)	Margin (dB)	Height (cm)	Pol	Azimuth (deg)	Corr. (dB/m)
3990.000000	47.15	---	74.00	26.85	100.0	V	53.0	-13.4
3999.375000	---	31.49	54.00	22.51	100.0	V	198.0	-13.3
4818.750000	---	43.63	54.00	10.37	200.0	V	354.0	-10.7
4828.125000	52.47	---	74.00	21.53	200.0	V	345.0	-10.7
6665.625000	47.68	---	74.00	26.32	100.0	V	63.0	-3.5
7231.875000	---	35.19	54.00	18.81	200.0	H	354.0	-4.6
9283.125000	49.79	---	74.00	24.21	200.0	V	153.0	-2.9
9350.625000	---	38.50	54.00	15.50	200.0	V	16.0	-2.7
12414.375000	---	41.73	54.00	12.27	200.0	V	238.0	1.6
12795.000000	53.22	---	74.00	20.78	100.0	V	237.0	2.1
15236.250000	56.50	---	74.00	17.50	100.0	H	306.0	5.4
15241.875000	---	44.80	54.00	9.20	100.0	V	139.0	5.4

Remark: 1. Correction Factor = Antenna factor+ Insertion loss (cable loss + amplifier gain)



802.11g CH2

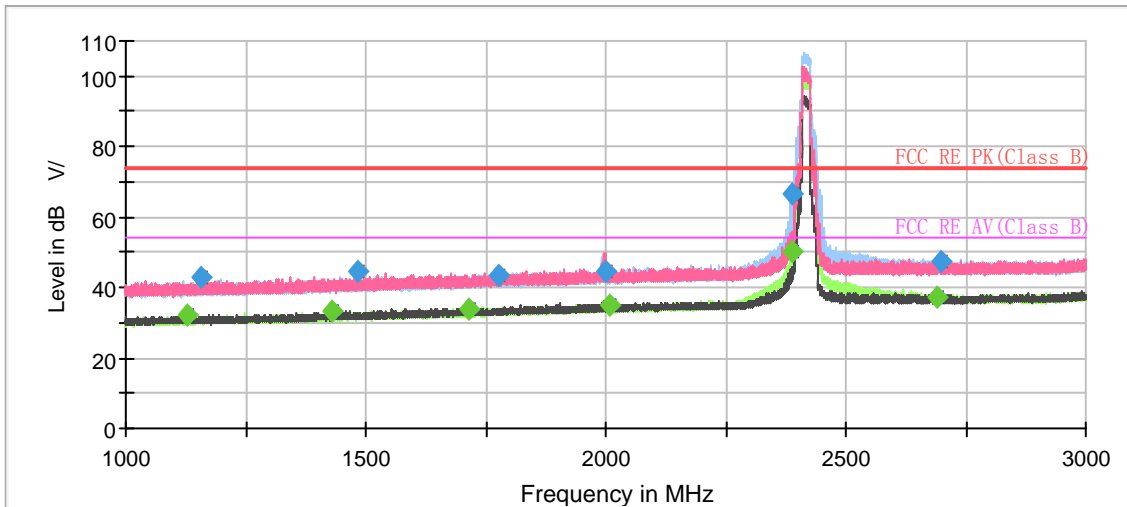

Note: The signal beyond the limit is carrier.

Radiates Emission from 1GHz to 3GHz

Frequency (MHz)	MaxPeak (dB μ V/m)	Average (dB μ V/m)	Limit (dB μ V/m)	Margin (dB)	Height (cm)	Pol	Azimuth (deg)	Corr. (dB/m)
1128.800000	---	32.38	54.00	21.62	100.0	V	0.0	-7.6
1157.733333	42.73	---	74.00	31.27	200.0	V	245.0	-7.5
1430.600000	---	33.50	54.00	20.50	100.0	V	238.0	-6.0
1482.266667	44.62	---	74.00	29.38	200.0	H	320.0	-5.7
1713.533333	---	34.13	54.00	19.87	100.0	V	205.0	-4.4
1778.133333	43.47	---	74.00	30.53	200.0	V	212.0	-4.0
2000.800000	44.63	---	74.00	29.37	200.0	H	50.0	-2.6
2007.400000	---	34.91	54.00	19.09	200.0	V	122.0	-2.6
2389.466667	---	50.04	54.00	3.96	200.0	H	184.0	-1.2
2389.800000	66.46	---	74.00	7.54	200.0	H	89.0	-1.2
2691.000000	---	37.37	54.00	16.63	100.0	H	294.0	0.5
2696.600000	47.13	---	74.00	26.87	200.0	H	192.0	0.5

Remark: 1. Correction Factor = Antenna factor+ Insertion loss (cable loss + amplifier gain)

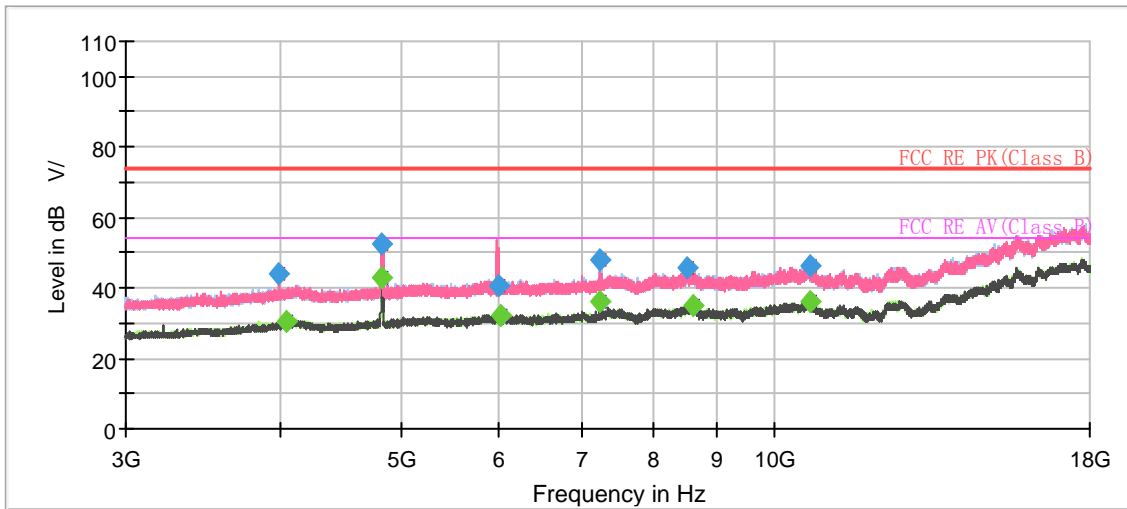

Radiates Emission from 3GHz to 18GHz

Frequency (MHz)	MaxPeak (dB μ V/m)	Average (dB μ V/m)	Limit (dB μ V/m)	Margin (dB)	Height (cm)	Pol	Azimuth (deg)	Corr. (dB/m)
3992.000000	44.11	---	74.00	29.89	100.0	V	89.0	-3.9
4038.500000	---	30.50	54.00	23.50	200.0	V	264.0	-3.6
4833.000000	---	42.93	54.00	11.07	200.0	V	158.0	-2.3
4835.500000	52.47	---	74.00	21.53	200.0	V	158.0	-2.3
6004.500000	40.64	---	74.00	33.36	200.0	H	8.0	-0.3
6030.000000	---	32.35	54.00	21.65	200.0	H	121.0	-0.4
7252.000000	---	36.15	54.00	17.85	100.0	H	0.0	1.3
7252.000000	47.82	---	74.00	26.18	100.0	H	0.0	1.3
8513.000000	45.72	---	74.00	28.28	100.0	H	12.0	3.9
8626.500000	---	35.20	54.00	18.80	100.0	H	88.0	3.8
10684.000000	46.02	---	74.00	27.98	100.0	H	238.0	5.3
10703.000000	---	36.27	54.00	17.73	100.0	H	325.0	5.3

Remark: 1. Correction Factor = Antenna factor+ Insertion loss (cable loss + amplifier gain)



802.11g CH6

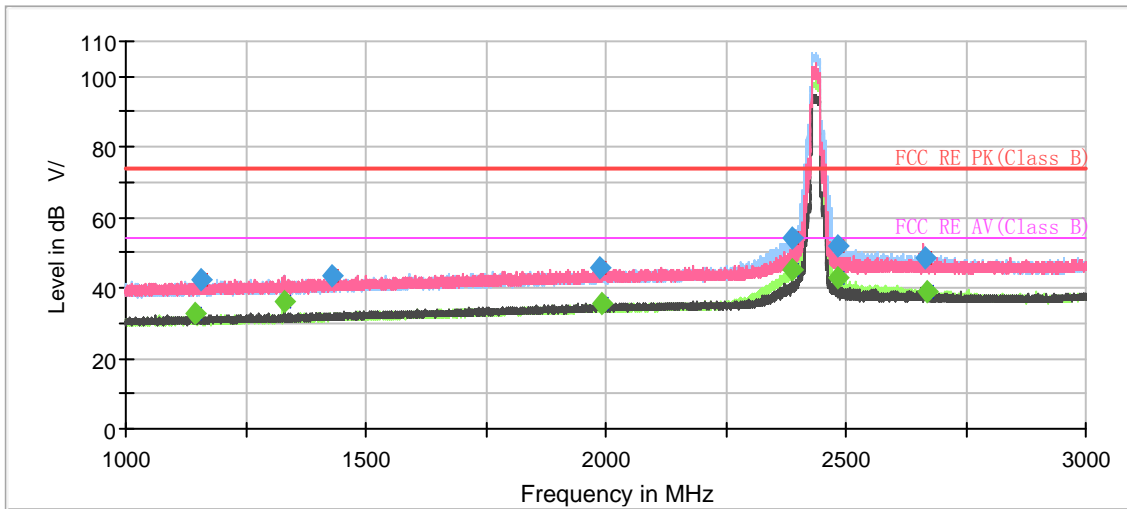

Note: The signal beyond the limit is carrier.

Radiates Emission from 1GHz to 3GHz

Frequency (MHz)	MaxPeak (dB μ V/m)	Average (dB μ V/m)	Limit (dB μ V/m)	Margin (dB)	Height (cm)	Pol	Azimuth (deg)	Corr. (dB/m)
1146.400000	---	32.44	54.00	21.56	100.0	V	284.0	-7.6
1158.666667	42.38	---	74.00	31.62	200.0	V	274.0	-7.5
1332.200000	---	35.88	54.00	18.12	200.0	H	229.0	-6.6
1431.466667	43.64	---	74.00	30.36	200.0	V	80.0	-6.0
1985.733333	45.78	---	74.00	28.22	100.0	V	193.0	-2.7
1989.800000	---	35.57	54.00	18.43	200.0	V	218.0	-2.7
2388.800000	54.31	---	74.00	19.69	100.0	H	0.0	-1.2
2389.000000	---	44.86	54.00	9.14	200.0	H	122.0	-1.2
2485.200000	52.01	---	74.00	21.99	200.0	H	357.0	-0.7
2485.533333	---	42.65	54.00	11.35	100.0	H	0.0	-0.7
2665.133333	48.37	---	74.00	25.63	100.0	V	169.0	0.4
2670.533333	---	38.65	54.00	15.35	100.0	H	304.0	0.4

Remark: 1. Correction Factor = Antenna factor+ Insertion loss (cable loss + amplifier gain)

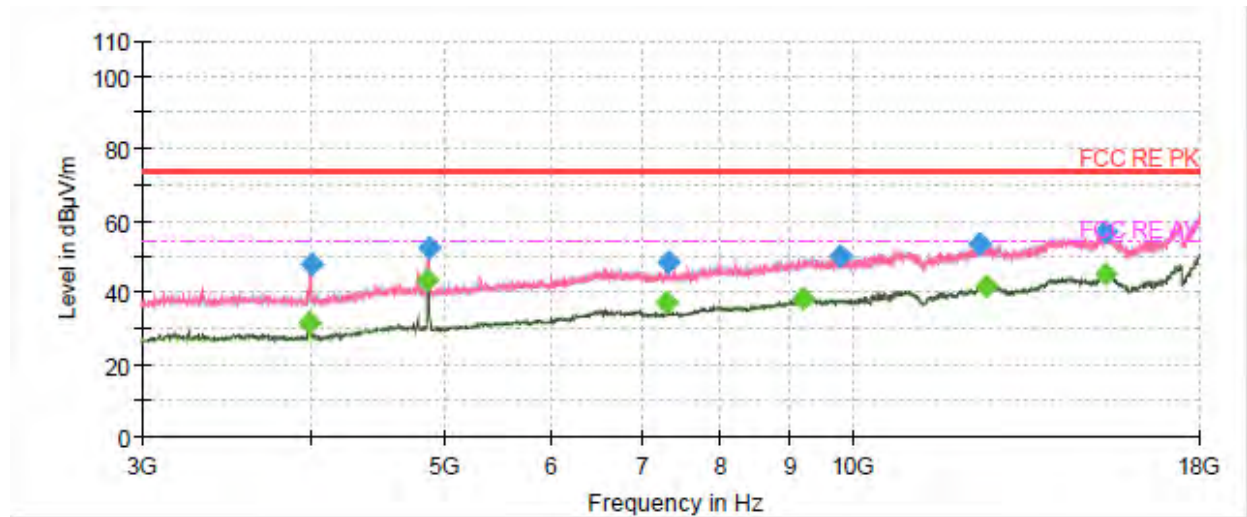

Radiates Emission from 3GHz to 18GHz

Frequency (MHz)	MaxPeak (dB μ V/m)	Average (dB μ V/m)	Limit (dB μ V/m)	Margin (dB)	Height (cm)	Pol	Azimuth (deg)	Corr. (dB/m)
3984.375000	---	31.44	54.00	22.56	100.0	V	71.0	-13.4
3997.500000	48.12	---	74.00	25.88	100.0	V	71.0	-13.3
4871.250000	---	43.37	54.00	10.63	200.0	V	346.0	-10.7
4875.000000	52.53	---	74.00	21.47	200.0	V	346.0	-10.7
7306.875000	---	37.23	54.00	16.77	200.0	H	350.0	-4.4
7308.750000	48.29	---	74.00	25.71	200.0	H	350.0	-4.4
9215.625000	---	38.51	54.00	15.49	100.0	H	9.0	-2.8
9789.375000	50.08	---	74.00	23.92	100.0	V	356.0	-2.1
12420.000000	53.35	---	74.00	20.65	100.0	H	4.0	1.6
12541.875000	---	41.61	54.00	12.39	100.0	H	107.0	2.0
15343.125000	57.20	---	74.00	16.80	100.0	V	356.0	5.8
15376.875000	---	45.02	54.00	8.98	100.0	V	185.0	5.7

Remark: 1. Correction Factor = Antenna factor+ Insertion loss (cable loss + amplifier gain)



802.11g CH10

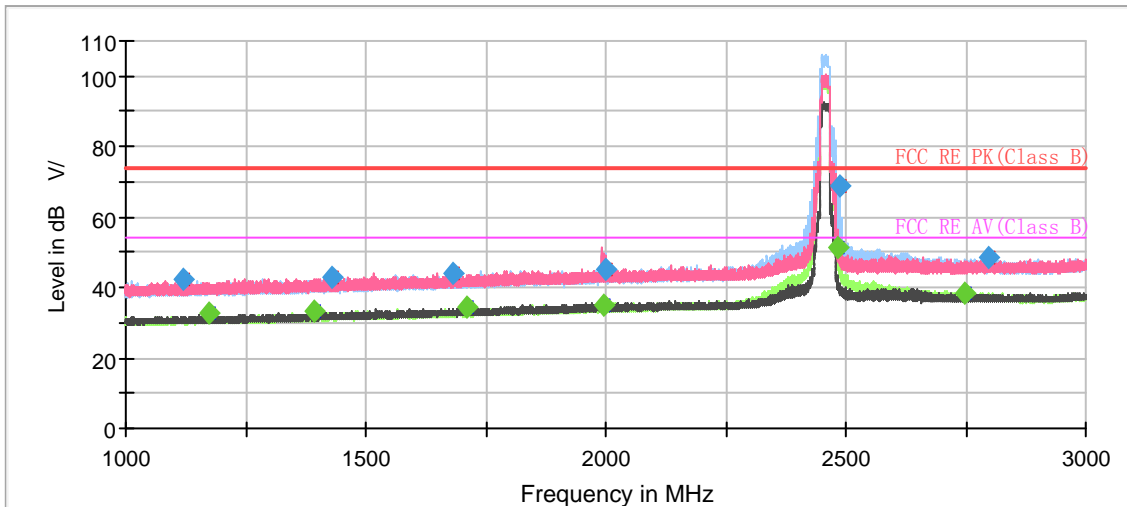

Note: The signal beyond the limit is carrier.
Radiates Emission from 1GHz to 3GHz

Frequency (MHz)	MaxPeak (dB μ V/m)	Average (dB μ V/m)	Limit (dB μ V/m)	Margin (dB)	Height (cm)	Pol	Azimuth (deg)	Corr. (dB/m)
1118.200000	42.12	---	74.00	31.88	200.0	H	320.0	-7.7
1173.066667	---	32.49	54.00	21.51	100.0	H	346.0	-7.4
1391.866667	---	33.10	54.00	20.90	100.0	H	314.0	-6.2
1430.866667	42.62	---	74.00	31.38	100.0	H	314.0	-6.0
1681.133333	44.26	---	74.00	29.74	200.0	V	250.0	-4.6
1710.933333	---	34.19	54.00	19.81	200.0	V	242.0	-4.4
1996.600000	---	34.82	54.00	19.18	100.0	H	305.0	-2.7
1999.133333	44.93	---	74.00	29.07	100.0	H	23.0	-2.7
2484.866667	---	51.18	54.00	2.82	100.0	H	186.0	-0.7
2486.533333	68.91	---	74.00	5.09	100.0	H	186.0	-0.7
2748.266667	---	38.52	54.00	15.48	200.0	H	0.0	0.7
2798.200000	48.46	---	74.00	25.54	100.0	H	353.0	0.9

Remark: 1. Correction Factor = Antenna factor+ Insertion loss (cable loss + amplifier gain)

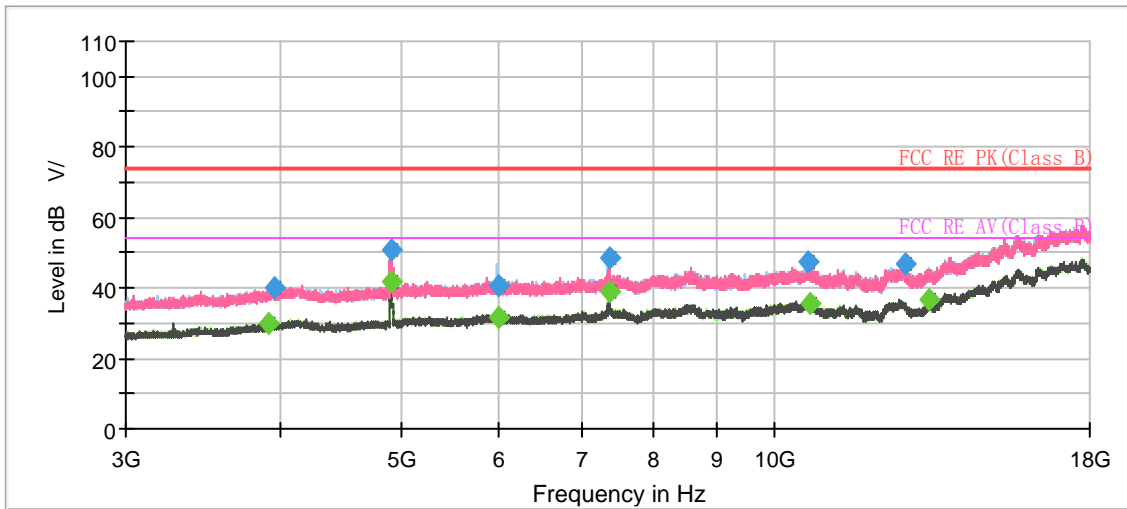

Radiates Emission from 3GHz to 18GHz

Frequency (MHz)	MaxPeak (dB μ V/m)	Average (dB μ V/m)	Limit (dB μ V/m)	Margin (dB)	Height (cm)	Pol	Azimuth (deg)	Corr. (dB/m)
3910.500000	---	30.17	54.00	23.83	100.0	H	310.0	-4.5
3955.500000	39.84	---	74.00	34.16	200.0	H	78.0	-4.2
4913.500000	---	41.68	54.00	12.32	100.0	V	64.0	-1.8
4914.500000	50.75	---	74.00	23.25	100.0	H	35.0	-1.8
6000.500000	---	31.71	54.00	22.29	200.0	V	183.0	-0.3
6004.000000	40.77	---	74.00	33.23	100.0	V	100.0	-0.3
7370.500000	48.31	---	74.00	25.69	200.0	H	0.0	1.5
7372.000000	---	38.74	54.00	15.26	100.0	H	0.0	1.5
10654.500000	47.20	---	74.00	26.80	200.0	V	322.0	5.4
10692.000000	---	35.69	54.00	18.31	100.0	H	89.0	5.3
12777.500000	46.97	---	74.00	27.03	100.0	V	126.0	7.6
13334.500000	---	36.41	54.00	17.59	100.0	H	345.0	8.7

Remark: 1. Correction Factor = Antenna factor+ Insertion loss (cable loss + amplifier gain)



802.11g CH11

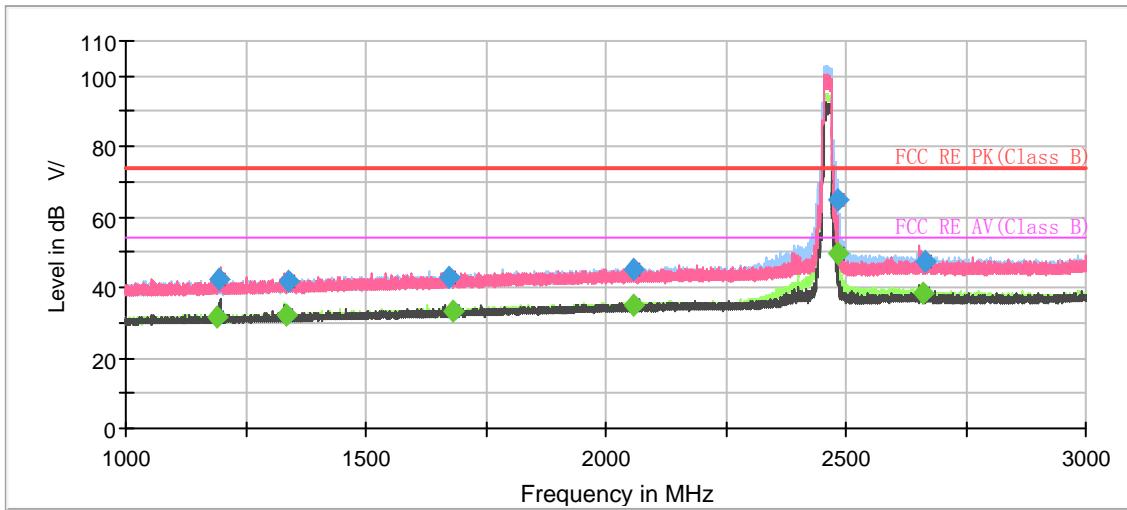

Note: The signal beyond the limit is carrier.

Radiates Emission from 1GHz to 3GHz

Frequency (MHz)	MaxPeak (dB μ V/m)	Average (dB μ V/m)	Limit (dB μ V/m)	Margin (dB)	Height (cm)	Pol	Azimuth (deg)	Corr. (dB/m)
1190.733333	---	31.44	54.00	22.56	100.0	H	179.0	-7.3
1193.866667	42.20	---	74.00	31.80	100.0	V	0.0	-7.3
1336.066667	---	31.94	54.00	22.06	100.0	H	298.0	-6.6
1340.400000	41.50	---	74.00	32.50	100.0	H	218.0	-6.6
1674.800000	42.64	---	74.00	31.36	200.0	H	67.0	-4.6
1681.466667	---	33.47	54.00	20.53	100.0	H	187.0	-4.6
2057.400000	---	35.18	54.00	18.82	100.0	V	66.0	-2.4
2059.000000	45.12	---	74.00	28.88	200.0	H	221.0	-2.4
2484.133333	---	49.67	54.00	4.33	100.0	H	354.0	-0.7
2484.733333	64.95	---	74.00	9.05	200.0	H	0.0	-0.7
2659.800000	---	38.37	54.00	15.63	100.0	H	147.0	0.4
2665.800000	47.54	---	74.00	26.46	200.0	H	312.0	0.4

Remark: 1. Correction Factor = Antenna factor+ Insertion loss (cable loss + amplifier gain)

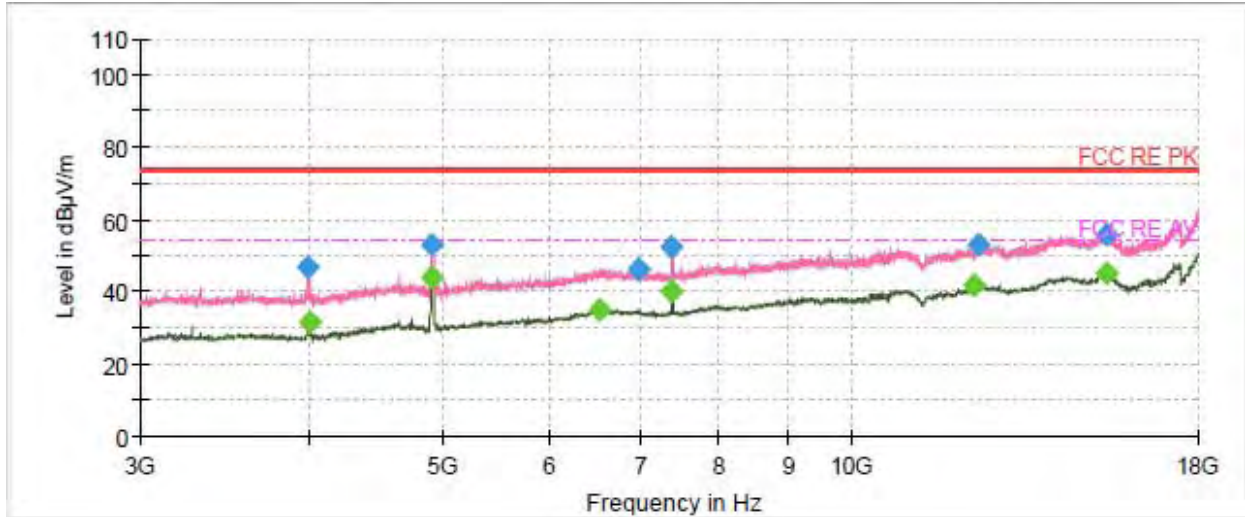

Radiates Emission from 3GHz to 18GHz

Frequency (MHz)	MaxPeak (dB µ V/m)	Average (dB µ V/m)	Limit (dB µ V/m)	Margin (dB)	Height (cm)	Pol	Azimuth (deg)	Corr. (dB/m)
3990.000000	47.00	---	74.00	27.00	100.0	H	354.0	-13.4
3993.750000	---	31.51	54.00	22.49	200.0	V	6.0	-13.3
4916.250000	53.01	---	74.00	20.99	200.0	V	2.0	-10.6
4923.750000	---	43.93	54.00	10.07	200.0	V	20.0	-10.6
6541.875000	---	34.98	54.00	19.02	100.0	V	133.0	-3.7
6976.875000	46.41	---	74.00	27.59	200.0	H	209.0	-3.8
7383.750000	---	39.90	54.00	14.10	100.0	H	178.0	-4.3
7383.750000	52.38	---	74.00	21.62	100.0	H	178.0	-4.3
12309.375000	---	41.87	54.00	12.13	100.0	H	1.0	1.4
12393.750000	52.92	---	74.00	21.08	100.0	V	278.0	1.5
15395.625000	---	45.00	54.00	9.00	100.0	H	4.0	5.6
15410.625000	55.63	---	74.00	18.37	100.0	H	44.0	5.6

Remark: 1. Correction Factor = Antenna factor+ Insertion loss (cable loss + amplifier gain)



802.11n (HT20) CH1

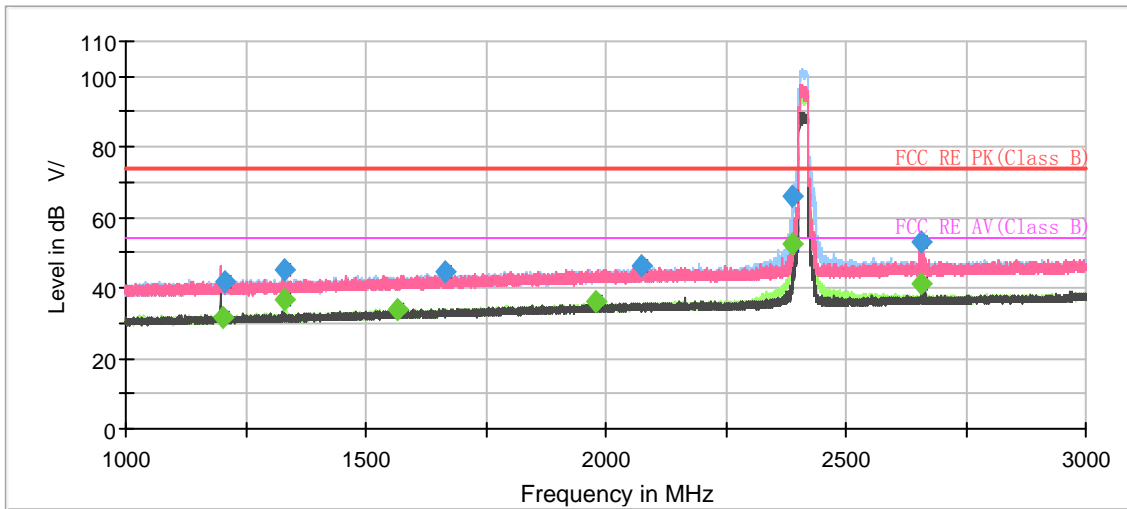

Note: The signal beyond the limit is carrier.
Radiates Emission from 1GHz to 3GHz

Frequency (MHz)	MaxPeak (dB μ V/m)	Average (dB μ V/m)	Limit (dB μ V/m)	Margin (dB)	Height (cm)	Pol	Azimuth (deg)	Corr. (dB/m)
1202.866667	---	31.85	54.00	22.15	100.0	V	9.0	-7.3
1208.066667	41.58	---	74.00	32.42	200.0	H	0.0	-7.3
1332.000000	45.03	---	74.00	28.97	100.0	H	124.0	-6.6
1332.000000	---	36.40	54.00	17.60	100.0	H	124.0	-6.6
1565.000000	---	34.12	54.00	19.88	100.0	V	49.0	-5.2
1666.733333	44.46	---	74.00	29.54	200.0	V	168.0	-4.7
1978.733333	---	35.88	54.00	18.12	100.0	V	57.0	-2.8
2073.600000	46.21	---	74.00	27.79	200.0	H	244.0	-2.4
2389.400000	---	52.59	54.00	1.41	100.0	H	0.0	-1.2
2389.533333	66.09	---	74.00	7.91	100.0	H	356.0	-1.2
2655.333333	---	41.44	54.00	12.56	100.0	V	173.0	0.4
2656.000000	52.78	---	74.00	21.22	100.0	V	173.0	0.4

Remark: 1. Correction Factor = Antenna factor+ Insertion loss (cable loss + amplifier gain)

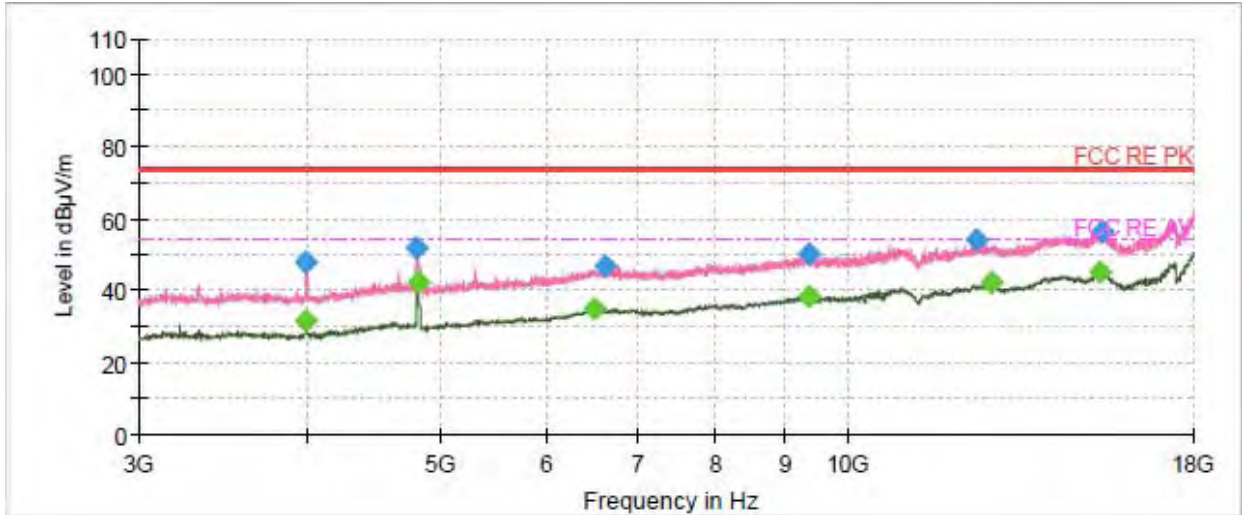

Radiates Emission from 3GHz to 18GHz

Frequency (MHz)	MaxPeak (dB µ V/m)	Average (dB µ V/m)	Limit (dB µ V/m)	Margin (dB)	Height (cm)	Pol	Azimuth (deg)	Corr. (dB/m)
3984.375000	47.75	---	74.00	26.25	100.0	H	239.0	-13.4
3990.000000	---	31.45	54.00	22.55	100.0	V	198.0	-13.4
4811.250000	51.88	---	74.00	22.12	200.0	V	353.0	-10.6
4824.375000	---	42.15	54.00	11.85	200.0	V	353.0	-10.7
6510.000000	---	35.07	54.00	18.93	100.0	H	57.0	-3.7
6639.375000	46.88	---	74.00	27.12	100.0	H	181.0	-3.5
9367.500000	---	38.61	54.00	15.39	100.0	V	293.0	-2.7
9373.125000	50.03	---	74.00	23.97	200.0	V	8.0	-2.7
12444.375000	53.91	---	74.00	20.09	200.0	H	225.0	1.7
12795.000000	---	42.13	54.00	11.87	200.0	H	359.0	2.1
15352.500000	---	45.02	54.00	8.98	100.0	H	307.0	5.8
15391.875000	56.60	---	74.00	17.40	100.0	H	7.0	5.7

Remark: 1. Correction Factor = Antenna factor+ Insertion loss (cable loss + amplifier gain)



802.11n (HT20) CH2

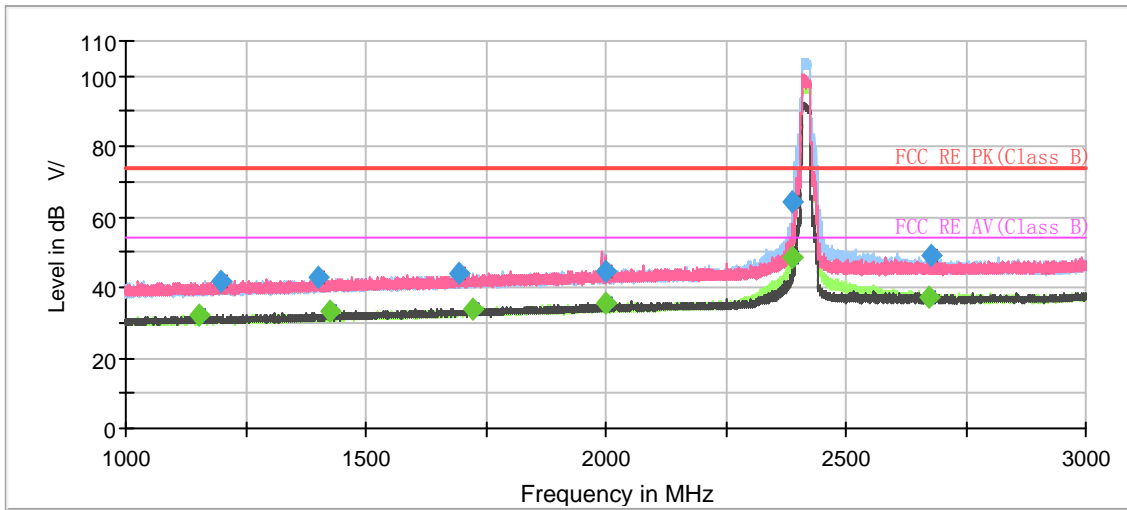

Note: The signal beyond the limit is carrier.

Radiates Emission from 1GHz to 3GHz

Frequency (MHz)	MaxPeak (dB μ V/m)	Average (dB μ V/m)	Limit (dB μ V/m)	Margin (dB)	Height (cm)	Pol	Azimuth (deg)	Corr. (dB/m)
1151.600000	---	32.00	54.00	22.00	200.0	V	104.0	-7.5
1196.866667	41.94	---	74.00	32.06	100.0	H	248.0	-7.3
1402.533333	43.00	---	74.00	31.00	200.0	V	321.0	-6.1
1427.133333	---	33.04	54.00	20.96	200.0	V	281.0	-6.0
1695.200000	44.16	---	74.00	29.84	200.0	V	191.0	-4.5
1724.400000	---	34.02	54.00	19.98	200.0	V	176.0	-4.3
1999.133333	44.50	---	74.00	29.50	100.0	V	9.0	-2.7
2000.133333	---	35.32	54.00	18.68	100.0	V	357.0	-2.7
2388.533333	---	48.52	54.00	5.48	200.0	H	186.0	-1.2
2389.133333	64.40	---	74.00	9.60	100.0	H	87.0	-1.2
2672.133333	---	37.27	54.00	16.73	100.0	H	167.0	0.4
2676.400000	48.83	---	74.00	25.17	200.0	H	82.0	0.5

Remark: 1. Correction Factor = Antenna factor+ Insertion loss (cable loss + amplifier gain)

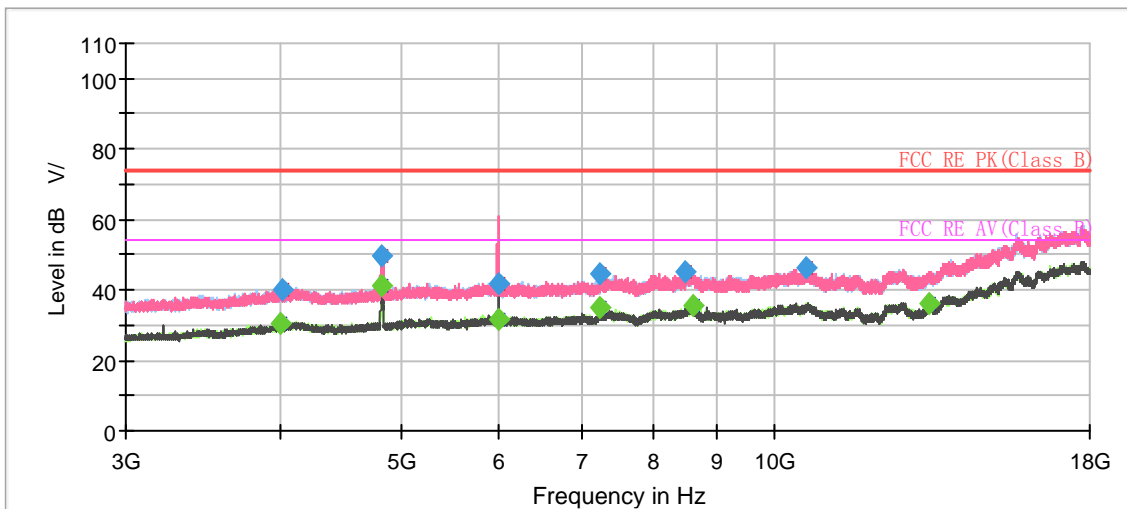

Radiates Emission from 3GHz to 18GHz

Frequency (MHz)	MaxPeak (dB μ V/m)	Average (dB μ V/m)	Limit (dB μ V/m)	Margin (dB)	Height (cm)	Pol	Azimuth (deg)	Corr. (dB/m)
3996.000000	---	30.54	54.00	23.46	200.0	H	282.0	-3.9
4010.500000	40.30	---	74.00	33.70	100.0	V	35.0	-3.8
4825.500000	49.59	---	74.00	24.41	200.0	V	159.0	-2.4
4833.500000	---	41.26	54.00	12.74	200.0	V	147.0	-2.3
6008.000000	41.59	---	74.00	32.41	200.0	H	43.0	-0.3
6009.000000	---	31.72	54.00	22.28	200.0	H	0.0	-0.3
7249.500000	---	34.80	54.00	19.20	100.0	H	1.0	1.3
7249.500000	44.35	---	74.00	29.65	100.0	H	1.0	1.3
8498.000000	44.99	---	74.00	29.01	100.0	V	123.0	3.8
8617.500000	---	35.72	54.00	18.28	100.0	H	282.0	3.8
10642.000000	46.41	---	74.00	27.59	200.0	H	17.0	5.4
13343.000000	---	36.22	54.00	17.78	200.0	V	320.0	8.7

Remark: 1. Correction Factor = Antenna factor+ Insertion loss (cable loss + amplifier gain)

802.11n (HT20) CH6

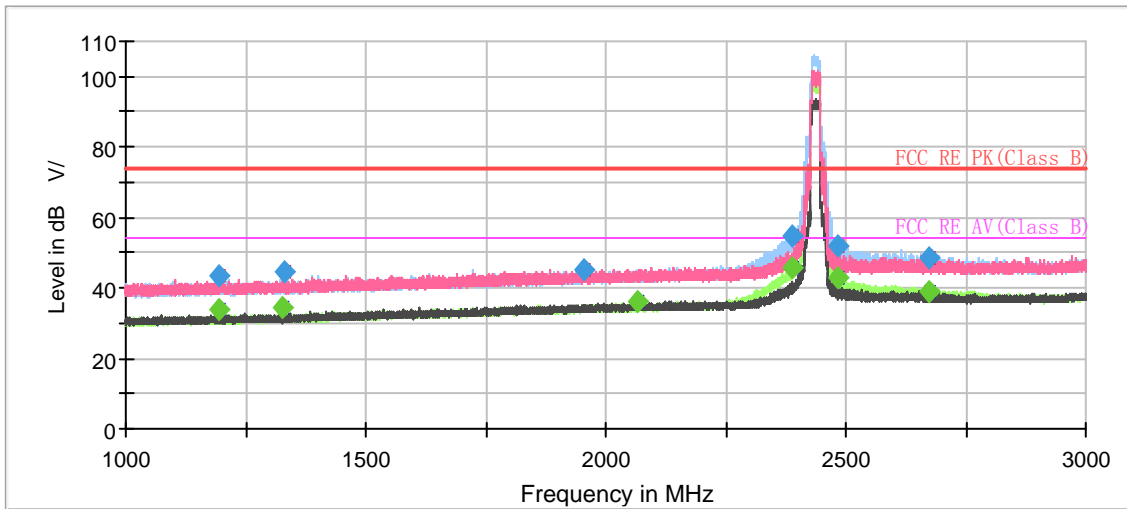

Note: The signal beyond the limit is carrier.

Radiates Emission from 1GHz to 3GHz

Frequency (MHz)	MaxPeak (dB μ V/m)	Average (dB μ V/m)	Limit (dB μ V/m)	Margin (dB)	Height (cm)	Pol	Azimuth (deg)	Corr. (dB/m)
1194.800000	---	33.95	54.00	20.05	200.0	V	7.0	-7.3
1195.000000	43.18	---	74.00	30.82	200.0	V	7.0	-7.3
1328.133333	---	34.54	54.00	19.46	100.0	V	337.0	-6.6
1328.533333	44.47	---	74.00	29.53	200.0	H	237.0	-6.6
1952.600000	45.37	---	74.00	28.63	200.0	H	74.0	-3.0
2065.200000	---	36.03	54.00	17.97	100.0	H	106.0	-2.4
2388.200000	---	45.87	54.00	8.13	200.0	H	138.0	-1.2
2388.200000	54.65	---	74.00	19.35	200.0	H	138.0	-1.2
2485.200000	---	42.83	54.00	11.17	200.0	H	3.0	-0.7
2485.333333	51.66	---	74.00	22.34	100.0	H	139.0	-0.7
2674.133333	48.28	---	74.00	25.72	100.0	H	196.0	0.5
2675.000000	---	39.03	54.00	14.97	100.0	H	64.0	0.5

Remark: 1. Correction Factor = Antenna factor+ Insertion loss (cable loss + amplifier gain)

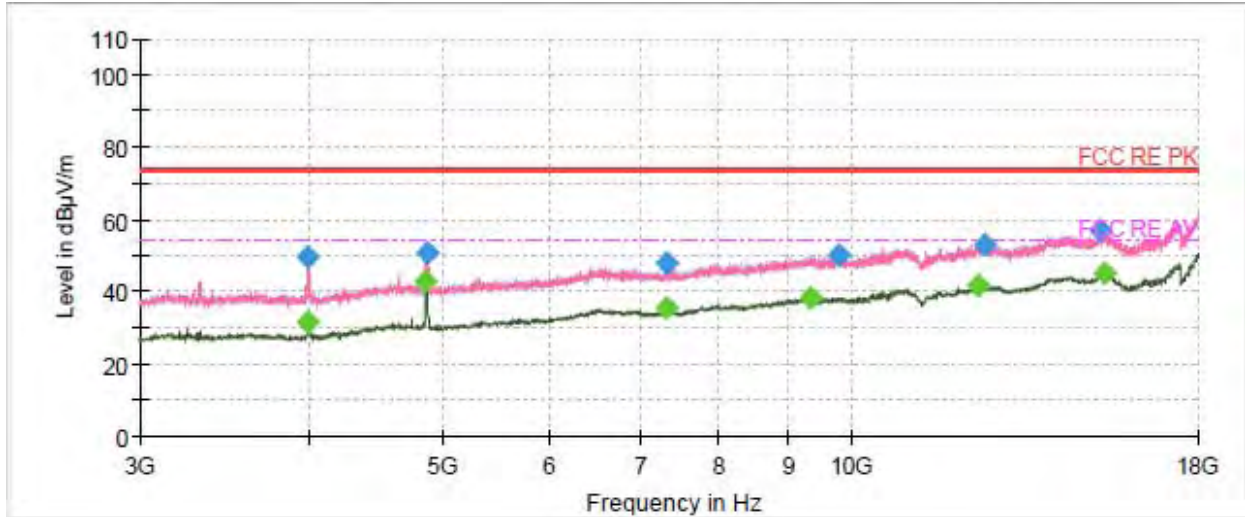

Radiates Emission from 3GHz to 18GHz

Frequency (MHz)	MaxPeak (dB µ V/m)	Average (dB µ V/m)	Limit (dB µ V/m)	Margin (dB)	Height (cm)	Pol	Azimuth (deg)	Corr. (dB/m)
3988.125000	---	31.71	54.00	22.29	100.0	V	72.0	-13.4
3990.000000	49.39	---	74.00	24.61	100.0	H	229.0	-13.4
4869.375000	---	42.95	54.00	11.05	200.0	V	354.0	-10.7
4880.625000	50.81	---	74.00	23.19	200.0	V	346.0	-10.7
7310.625000	---	35.66	54.00	18.34	100.0	H	181.0	-4.4
7316.250000	47.80	---	74.00	26.20	200.0	H	352.0	-4.4
9346.875000	---	38.57	54.00	15.43	100.0	H	190.0	-2.7
9802.500000	50.14	---	74.00	23.86	200.0	H	0.0	-2.0
12393.750000	---	41.97	54.00	12.03	100.0	V	82.0	1.5
12541.875000	53.22	---	74.00	20.78	100.0	H	28.0	2.0
15251.250000	56.70	---	74.00	17.30	100.0	H	14.0	5.5
15354.375000	---	45.03	54.00	8.97	100.0	H	14.0	5.8

Remark: 1. Correction Factor = Antenna factor+ Insertion loss (cable loss + amplifier gain)



802.11n (HT20) CH10

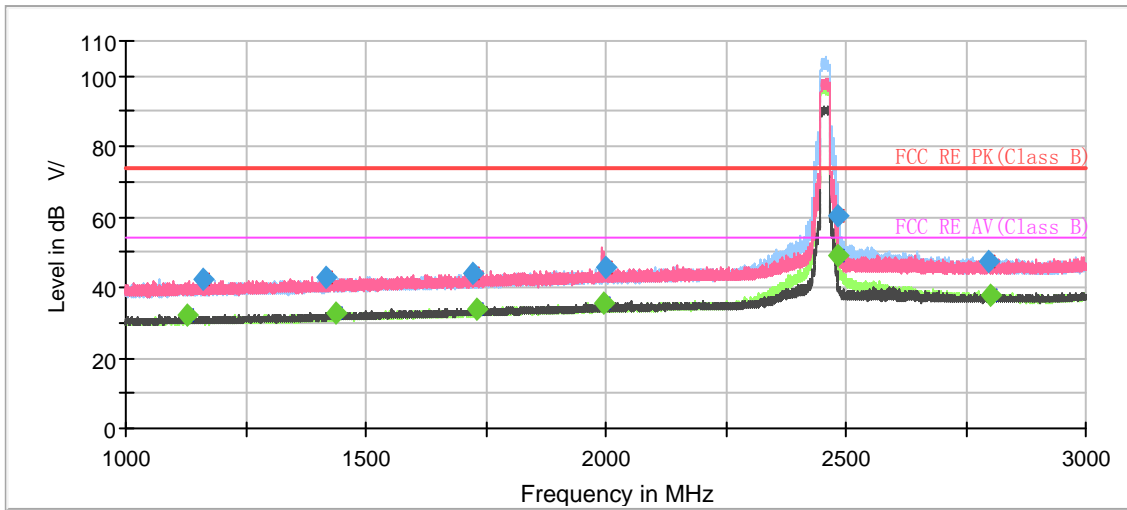

Note: The signal beyond the limit is carrier.

Radiates Emission from 1GHz to 3GHz

Frequency (MHz)	MaxPeak (dB μ V/m)	Average (dB μ V/m)	Limit (dB μ V/m)	Margin (dB)	Height (cm)	Pol	Azimuth (deg)	Corr. (dB/m)
1129.666667	---	31.90	54.00	22.10	200.0	H	313.0	-7.6
1162.200000	42.42	---	74.00	31.58	100.0	H	36.0	-7.5
1415.333333	42.96	---	74.00	31.04	100.0	V	113.0	-6.1
1437.333333	---	32.87	54.00	21.13	100.0	H	219.0	-5.9
1721.733333	43.97	---	74.00	30.03	200.0	V	18.0	-4.3
1730.600000	---	34.01	54.00	19.99	100.0	V	130.0	-4.3
1994.533333	---	35.31	54.00	18.69	200.0	H	220.0	-2.7
1999.933333	45.71	---	74.00	28.29	200.0	H	19.0	-2.7
2483.666667	---	48.82	54.00	5.18	100.0	H	168.0	-0.7
2483.733333	60.50	---	74.00	13.50	200.0	H	99.0	-0.7
2798.666667	47.14	---	74.00	26.86	200.0	H	0.0	0.9
2801.133333	---	37.96	54.00	16.04	200.0	H	0.0	0.9

Remark: 1. Correction Factor = Antenna factor+ Insertion loss (cable loss + amplifier gain)

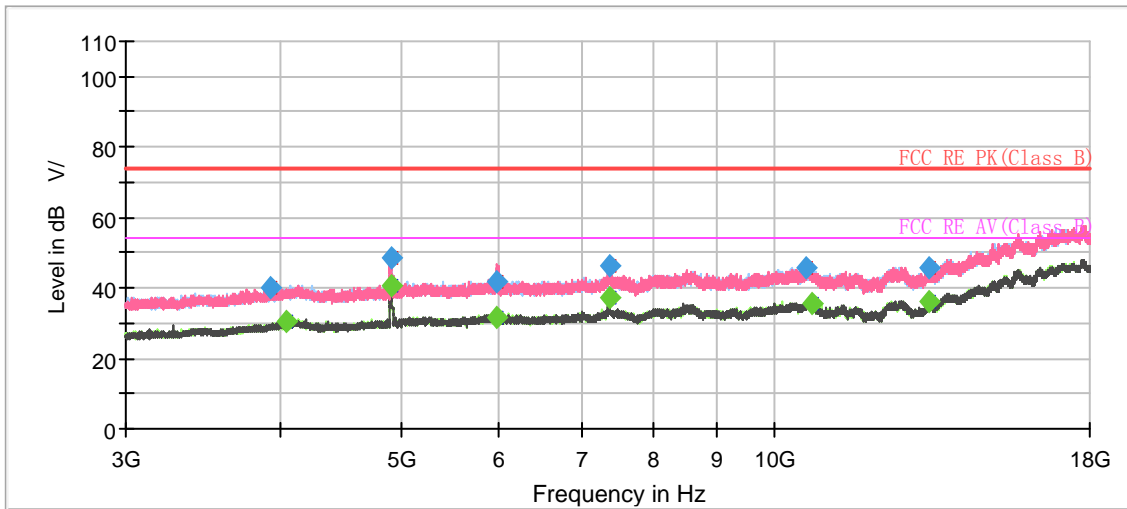

Radiates Emission from 3GHz to 18GHz

Frequency (MHz)	MaxPeak (dB μ V/m)	Average (dB μ V/m)	Limit (dB μ V/m)	Margin (dB)	Height (cm)	Pol	Azimuth (deg)	Corr. (dB/m)
3930.500000	39.92	---	74.00	34.08	100.0	H	192.0	-4.3
4041.000000	---	30.35	54.00	23.65	100.0	H	340.0	-3.6
4913.000000	---	40.58	54.00	13.42	100.0	V	209.0	-1.9
4918.500000	48.57	---	74.00	25.43	100.0	H	102.0	-1.8
5971.000000	---	31.33	54.00	22.67	200.0	H	11.0	-0.3
5985.500000	41.75	---	74.00	32.25	100.0	V	105.0	-0.3
7363.500000	---	37.38	54.00	16.62	100.0	H	357.0	1.5
7382.500000	46.31	---	74.00	27.69	100.0	H	7.0	1.5
10622.500000	45.63	---	74.00	28.37	100.0	H	67.0	5.5
10738.500000	---	35.74	54.00	18.26	200.0	H	126.0	5.2
13337.500000	---	36.35	54.00	17.65	100.0	V	62.0	8.7
13348.000000	45.94	---	74.00	28.06	200.0	V	316.0	8.7

Remark: 1. Correction Factor = Antenna factor+ Insertion loss (cable loss + amplifier gain)



802.11n (HT20) CH11

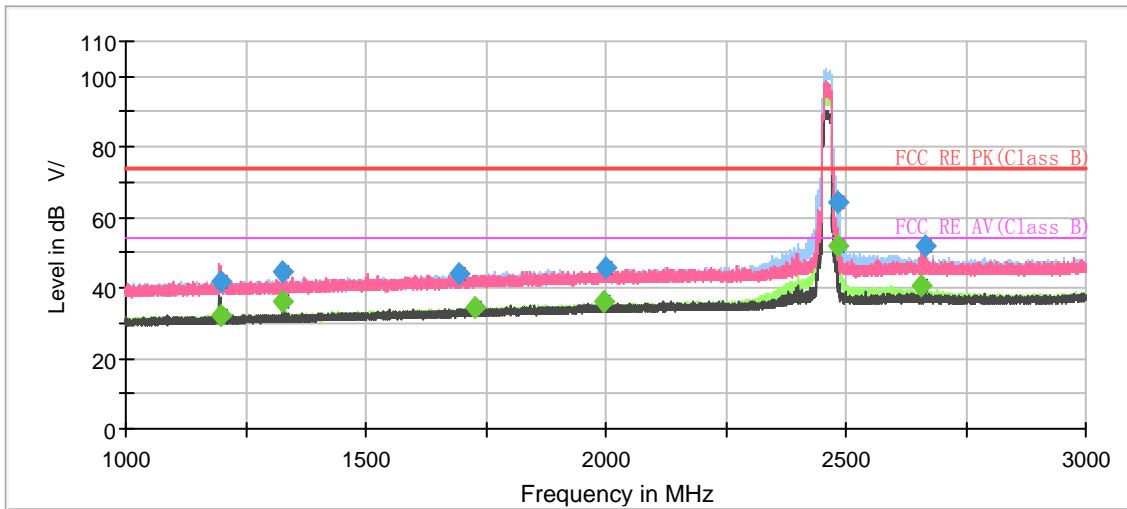

Note: The signal beyond the limit is carrier.

Radiates Emission from 1GHz to 3GHz

Frequency (MHz)	MaxPeak (dB μV/m)	Average (dB μV/m)	Limit (dB μV/m)	Margin (dB)	Height (cm)	Pol	Azimuth (deg)	Corr. (dB/m)
1200.066667	---	32.43	54.00	21.57	200.0	H	127.0	-7.3
1200.200000	41.77	---	74.00	32.23	100.0	V	0.0	-7.3
1327.933333	44.34	---	74.00	29.66	100.0	H	123.0	-6.6
1327.933333	---	36.30	54.00	17.70	100.0	H	123.0	-6.6
1693.666667	43.83	---	74.00	30.17	100.0	H	40.0	-4.5
1726.400000	---	34.23	54.00	19.77	100.0	V	49.0	-4.3
1997.466667	---	36.31	54.00	17.69	100.0	V	42.0	-2.7
1998.800000	45.90	---	74.00	28.10	100.0	V	1.0	-2.7
2483.866667	64.24	---	74.00	9.76	200.0	H	8.0	-0.7
2484.200000	---	51.83	54.00	2.17	200.0	H	0.0	-0.7
2656.866667	---	40.43	54.00	13.57	100.0	V	214.0	0.4
2665.733333	51.76	---	74.00	22.24	200.0	V	166.0	0.4

Remark: 1. Correction Factor = Antenna factor+ Insertion loss (cable loss + amplifier gain)

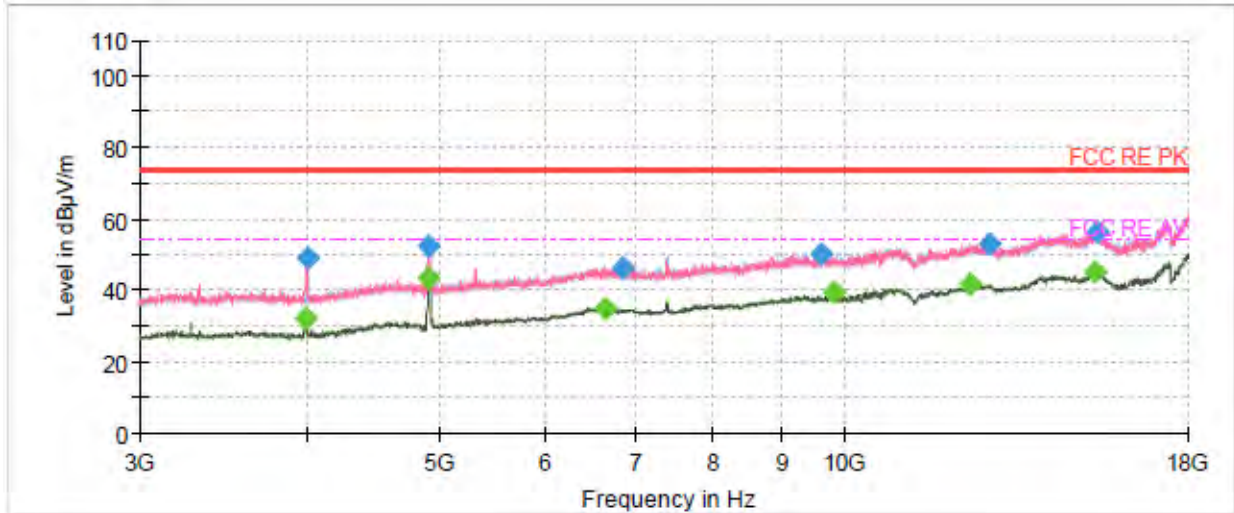

Radiates Emission from 3GHz to 18GHz

Frequency (MHz)	MaxPeak (dB μ V/m)	Average (dB μ V/m)	Limit (dB μ V/m)	Margin (dB)	Height (cm)	Pol	Azimuth (deg)	Corr. (dB/m)
3982.500000	---	31.88	54.00	22.12	100.0	V	1.0	-13.4
3993.750000	49.25	---	74.00	24.75	100.0	H	227.0	-13.3
4923.750000	52.50	---	74.00	21.50	200.0	V	24.0	-10.6
4923.750000	---	43.54	54.00	10.46	200.0	V	24.0	-10.6
6660.000000	---	35.15	54.00	18.85	100.0	V	306.0	-3.5
6862.500000	46.35	---	74.00	27.65	200.0	V	69.0	-3.8
9624.375000	50.26	---	74.00	23.74	200.0	H	273.0	-2.3
9849.375000	---	39.26	54.00	14.74	200.0	V	97.0	-1.8
12405.000000	---	41.66	54.00	12.34	200.0	V	12.0	1.6
12823.125000	53.25	---	74.00	20.75	200.0	H	292.0	2.1
15346.875000	---	44.87	54.00	9.13	200.0	H	283.0	5.8
15421.875000	56.55	---	74.00	17.45	100.0	H	84.0	5.5

Remark: 1. Correction Factor = Antenna factor+ Insertion loss (cable loss + amplifier gain)



802.11n (HT40) CH3

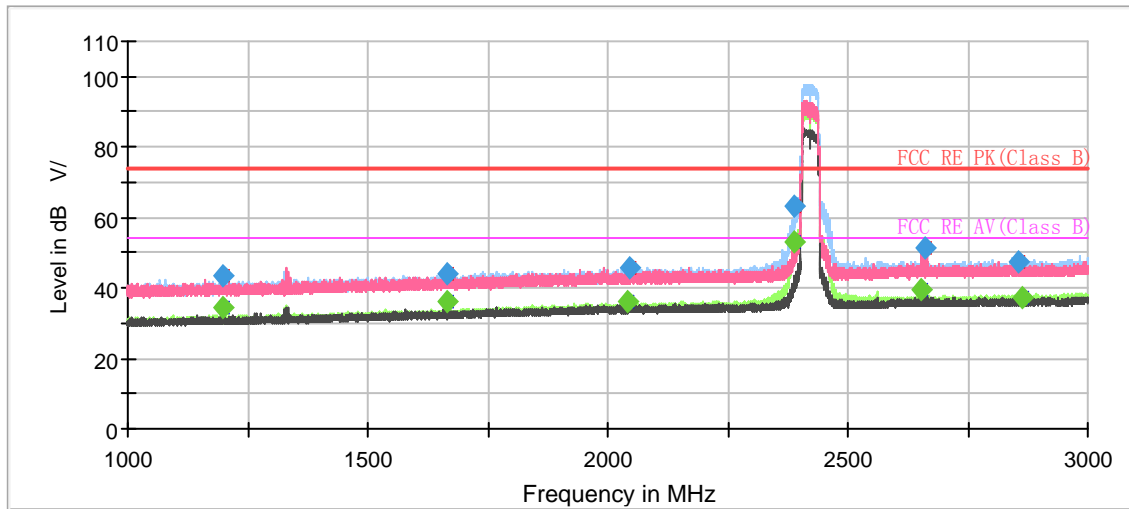

Note: The signal beyond the limit is carrier.

Radiates Emission from 1GHz to 3GHz

Frequency (MHz)	MaxPeak (dB μ V/m)	Average (dB μ V/m)	Limit (dB μ V/m)	Margin (dB)	Height (cm)	Pol	Azimuth (deg)	Corr. (dB/m)
1197.400000	43.52	---	74.00	30.48	200.0	V	7.0	-7.3
1198.400000	---	34.55	54.00	19.45	200.0	V	184.0	-7.3
1665.266667	44.15	---	74.00	29.85	100.0	V	208.0	-4.7
1665.266667	---	36.22	54.00	17.78	100.0	V	208.0	-4.7
2042.866667	---	35.84	54.00	18.16	100.0	H	121.0	-2.5
2044.333333	45.92	---	74.00	28.08	100.0	H	162.0	-2.5
2387.866667	63.24	---	74.00	10.76	100.0	H	0.0	-1.2
2388.266667	---	53.13	54.00	0.87	200.0	H	139.0	-1.2
2654.666667	---	39.24	54.00	14.76	100.0	V	175.0	0.4
2660.933333	51.33	---	74.00	22.67	200.0	V	176.0	0.4
2855.866667	47.17	---	74.00	26.83	200.0	H	313.0	1.1
2864.266667	---	37.11	54.00	16.89	200.0	H	187.0	1.1

Remark: 1. Correction Factor = Antenna factor+ Insertion loss (cable loss + amplifier gain)

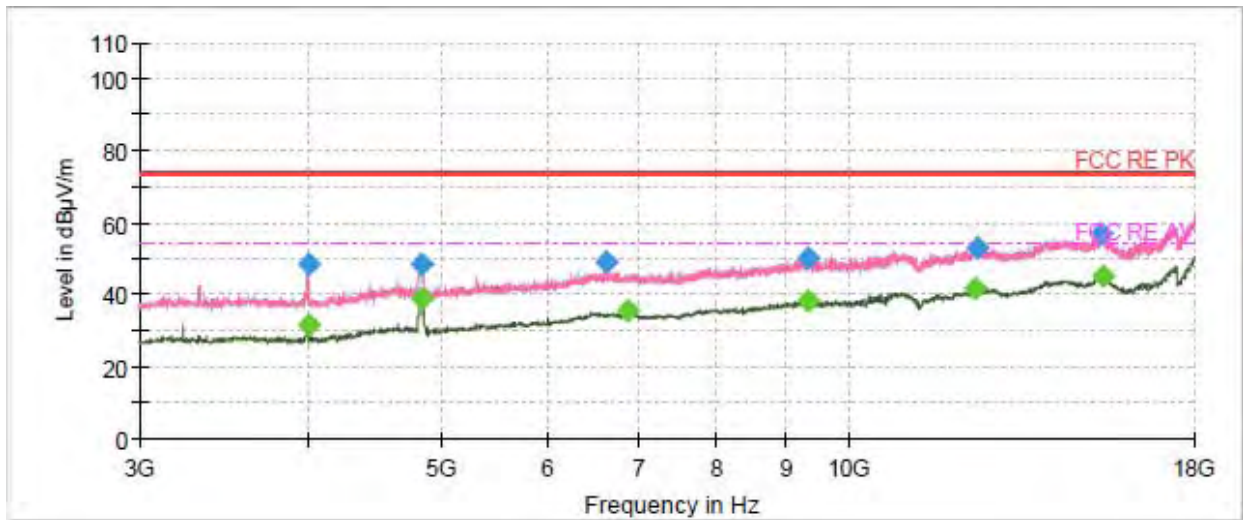

Radiates Emission from 3GHz to 18GHz

Frequency (MHz)	MaxPeak (dB µ V/m)	Average (dB µ V/m)	Limit (dB µ V/m)	Margin (dB)	Height (cm)	Pol	Azimuth (deg)	Corr. (dB/m)
3997.500000	---	31.66	54.00	22.34	100.0	V	63.0	-13.3
3999.375000	48.61	---	74.00	25.39	100.0	V	63.0	-13.3
4837.500000	---	39.12	54.00	14.88	200.0	V	5.0	-10.7
4848.750000	48.39	---	74.00	25.61	200.0	V	345.0	-10.7
6635.625000	48.93	---	74.00	25.07	200.0	V	246.0	-3.5
6886.875000	---	35.28	54.00	18.72	200.0	V	314.0	-3.8
9346.875000	---	38.55	54.00	15.45	200.0	H	167.0	-2.7
9348.750000	50.40	---	74.00	23.60	100.0	H	9.0	-2.7
12395.625000	---	41.82	54.00	12.18	100.0	V	275.0	1.5
12435.000000	53.08	---	74.00	20.92	100.0	V	358.0	1.7
15350.625000	56.73	---	74.00	17.27	100.0	H	82.0	5.8
15412.500000	---	45.08	54.00	8.92	100.0	V	275.0	5.6

Remark: 1. Correction Factor = Antenna factor+ Insertion loss (cable loss + amplifier gain)



802.11n (HT40) CH4

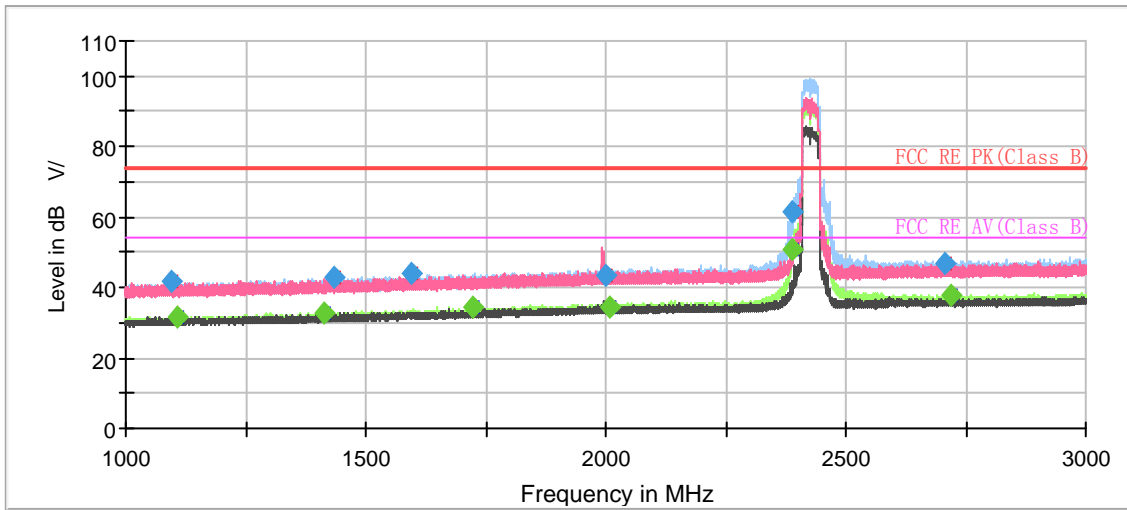

Note: The signal beyond the limit is carrier.

Radiates Emission from 1GHz to 3GHz

Frequency (MHz)	MaxPeak (dB μ V/m)	Average (dB μ V/m)	Limit (dB μ V/m)	Margin (dB)	Height (cm)	Pol	Azimuth (deg)	Corr. (dB/m)
1093.733333	41.58	---	74.00	32.42	100.0	H	36.0	-7.8
1109.333333	---	31.86	54.00	22.14	200.0	H	17.0	-7.7
1412.000000	---	32.99	54.00	21.01	200.0	H	104.0	-6.1
1433.866667	42.95	---	74.00	31.05	100.0	H	311.0	-6.0
1595.800000	43.82	---	74.00	30.18	200.0	H	119.0	-5.1
1724.133333	---	34.32	54.00	19.69	200.0	H	202.0	-4.3
1999.866667	43.62	---	74.00	30.38	100.0	H	342.0	-2.7
2009.533333	---	34.15	54.00	19.85	100.0	H	133.0	-2.6
2388.266667	61.76	---	74.00	12.24	200.0	H	88.0	-1.2
2388.333333	---	51.01	54.00	2.99	100.0	H	182.0	-1.2
2708.133333	46.93	---	74.00	27.07	200.0	H	33.0	0.6
2720.066667	---	37.61	54.00	16.39	200.0	H	119.0	0.6

Remark: 1. Correction Factor = Antenna factor+ Insertion loss (cable loss + amplifier gain)

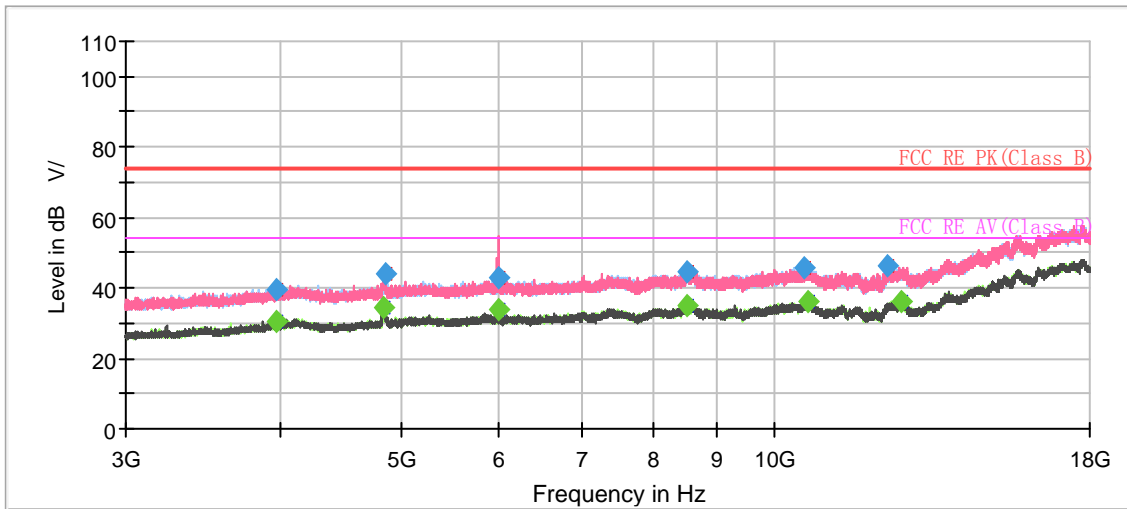

Radiates Emission from 3GHz to 18GHz

Frequency (MHz)	MaxPeak (dB μ V/m)	Average (dB μ V/m)	Limit (dB μ V/m)	Margin (dB)	Height (cm)	Pol	Azimuth (deg)	Corr. (dB/m)
3975.500000	---	30.53	54.00	23.47	200.0	V	229.0	-4.0
3977.000000	39.75	---	74.00	34.25	200.0	H	253.0	-4.0
4852.500000	---	34.67	54.00	19.33	200.0	V	159.0	-2.2
4857.500000	43.76	---	74.00	30.24	200.0	V	159.0	-2.2
5999.500000	42.62	---	74.00	31.38	100.0	H	98.0	-0.3
5999.500000	---	33.83	54.00	20.17	100.0	V	272.0	-0.3
8501.000000	44.66	---	74.00	29.34	100.0	V	25.0	3.8
8519.000000	---	35.16	54.00	18.84	100.0	V	93.0	3.9
10580.000000	45.61	---	74.00	28.39	100.0	H	336.0	5.5
10664.000000	---	36.35	54.00	17.65	100.0	V	59.0	5.4
12342.500000	46.22	---	74.00	27.78	100.0	V	272.0	6.7
12671.000000	---	35.84	54.00	18.16	200.0	H	113.0	7.4

Remark: 1. Correction Factor = Antenna factor+ Insertion loss (cable loss + amplifier gain)



802.11n (HT40) CH5

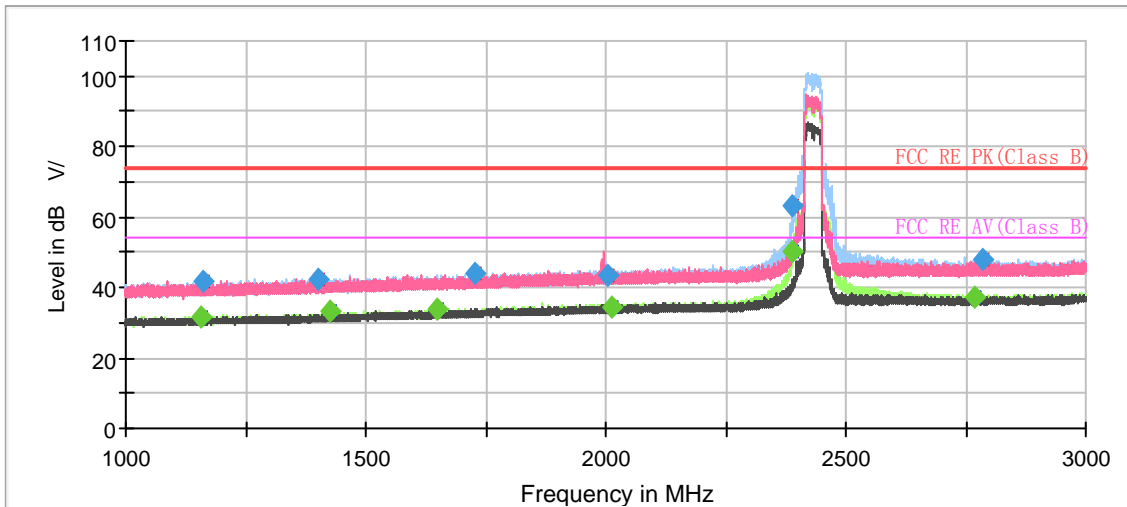

Note: The signal beyond the limit is carrier.
Radiates Emission from 1GHz to 3GHz

Frequency (MHz)	MaxPeak (dB μ V/m)	Average (dB μ V/m)	Limit (dB μ V/m)	Margin (dB)	Height (cm)	Pol	Azimuth (deg)	Corr. (dB/m)
1156.400000	---	31.83	54.00	22.17	100.0	H	0.0	-7.5
1161.666667	41.59	---	74.00	32.41	200.0	H	27.0	-7.5
1400.333333	42.53	---	74.00	31.47	200.0	H	16.0	-6.2
1425.866667	---	33.28	54.00	20.72	200.0	H	104.0	-6.0
1646.733333	---	34.11	54.00	19.89	100.0	V	21.0	-4.8
1728.066667	44.26	---	74.00	29.74	200.0	V	218.0	-4.3
2005.866667	43.62	---	74.00	30.38	200.0	H	312.0	-2.6
2014.333333	---	34.33	54.00	19.67	200.0	H	334.0	-2.6
2389.133333	63.31	---	74.00	10.69	200.0	H	89.0	-1.2
2389.933333	---	50.32	54.00	3.68	200.0	H	89.0	-1.2
2768.133333	---	37.16	54.00	16.84	200.0	H	136.0	0.8
2785.800000	48.01	---	74.00	25.99	100.0	H	268.0	0.9

Remark: 1. Correction Factor = Antenna factor+ Insertion loss (cable loss + amplifier gain)

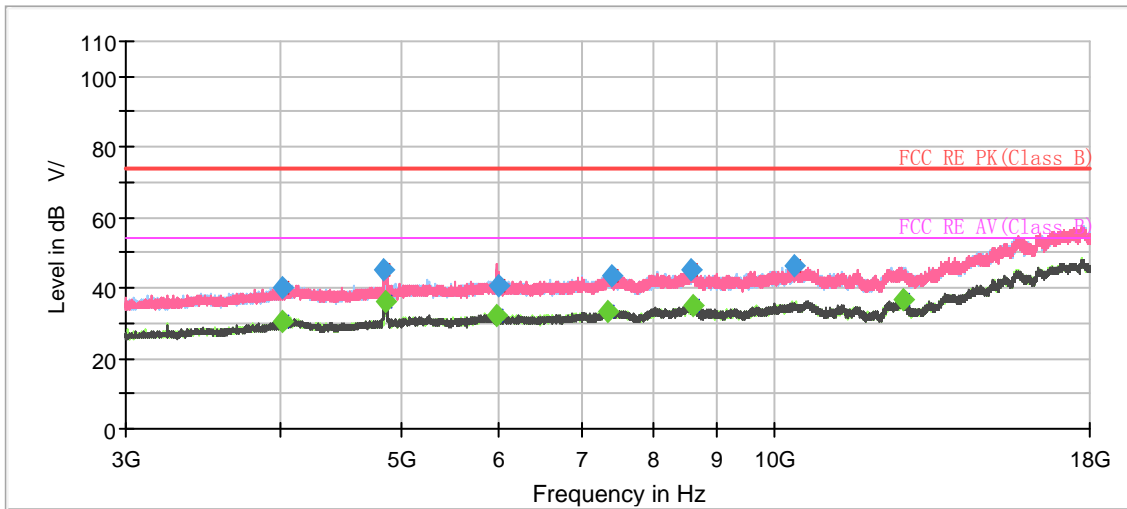

Radiates Emission from 3GHz to 18GHz

Frequency (MHz)	MaxPeak (dB μ V/m)	Average (dB μ V/m)	Limit (dB μ V/m)	Margin (dB)	Height (cm)	Pol	Azimuth (deg)	Corr. (dB/m)
4009.000000	---	30.41	54.00	23.59	200.0	V	299.0	-3.8
4018.500000	39.87	---	74.00	34.13	100.0	V	18.0	-3.7
4853.500000	45.27	---	74.00	28.73	200.0	V	157.0	-2.2
4862.000000	---	36.28	54.00	17.72	200.0	V	157.0	-2.2
5974.500000	---	32.21	54.00	21.79	200.0	H	128.0	-0.3
5999.500000	40.55	---	74.00	33.45	100.0	H	67.0	-0.3
7344.000000	---	33.35	54.00	20.65	200.0	H	49.0	1.4
7413.000000	43.57	---	74.00	30.43	100.0	V	0.0	1.5
8593.500000	44.95	---	74.00	29.05	200.0	V	122.0	3.9
8595.000000	---	34.87	54.00	19.13	200.0	V	0.0	3.9
10411.000000	46.22	---	74.00	27.78	200.0	H	163.0	5.9
12715.500000	---	36.41	54.00	17.59	200.0	V	316.0	7.5

Remark: 1. Correction Factor = Antenna factor+ Insertion loss (cable loss + amplifier gain)



802.11n (HT40) CH6

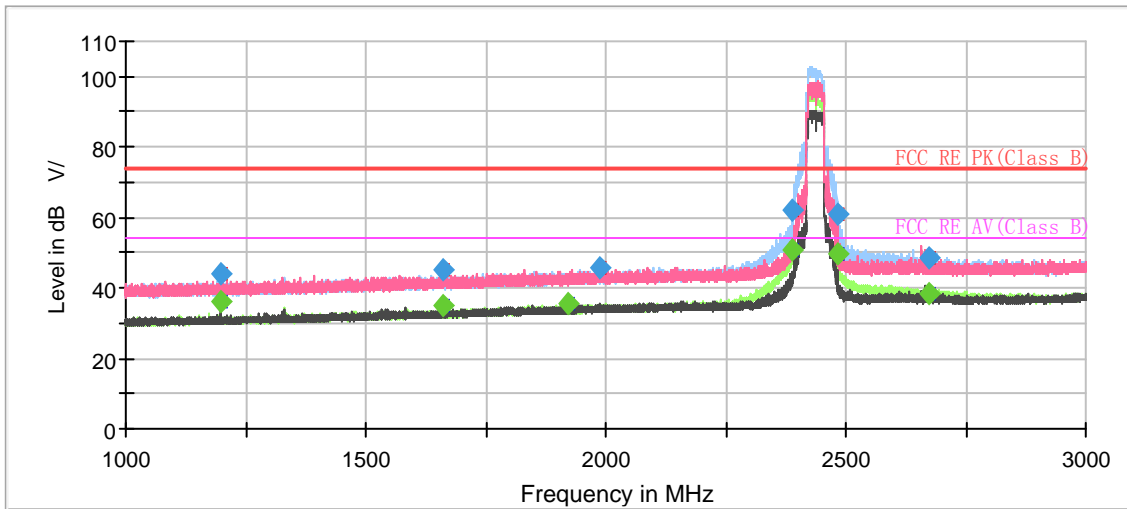

Note: The signal beyond the limit is carrier.

Radiates Emission from 1GHz to 3GHz

Frequency (MHz)	MaxPeak (dB μ V/m)	Average (dB μ V/m)	Limit (dB μ V/m)	Margin (dB)	Height (cm)	Pol	Azimuth (deg)	Corr. (dB/m)
1199.466667	---	35.91	54.00	18.09	200.0	V	357.0	-7.3
1199.733333	44.24	---	74.00	29.76	200.0	V	357.0	-7.3
1659.866667	45.04	---	74.00	28.96	100.0	V	217.0	-4.7
1662.800000	---	34.76	54.00	19.24	100.0	V	217.0	-4.7
1922.600000	---	35.43	54.00	18.57	100.0	H	194.0	-3.2
1988.800000	45.93	---	74.00	28.07	100.0	H	211.0	-2.7
2388.733333	61.78	---	74.00	12.22	100.0	H	356.0	-1.2
2389.066667	---	50.51	54.00	3.49	100.0	H	0.0	-1.2
2483.800000	---	49.63	54.00	4.37	100.0	H	0.0	-0.7
2485.266667	60.67	---	74.00	13.33	100.0	H	0.0	-0.7
2673.266667	48.47	---	74.00	25.53	200.0	H	4.0	0.4
2674.800000	---	38.33	54.00	15.67	100.0	H	56.0	0.5

Remark: 1. Correction Factor = Antenna factor+ Insertion loss (cable loss + amplifier gain)

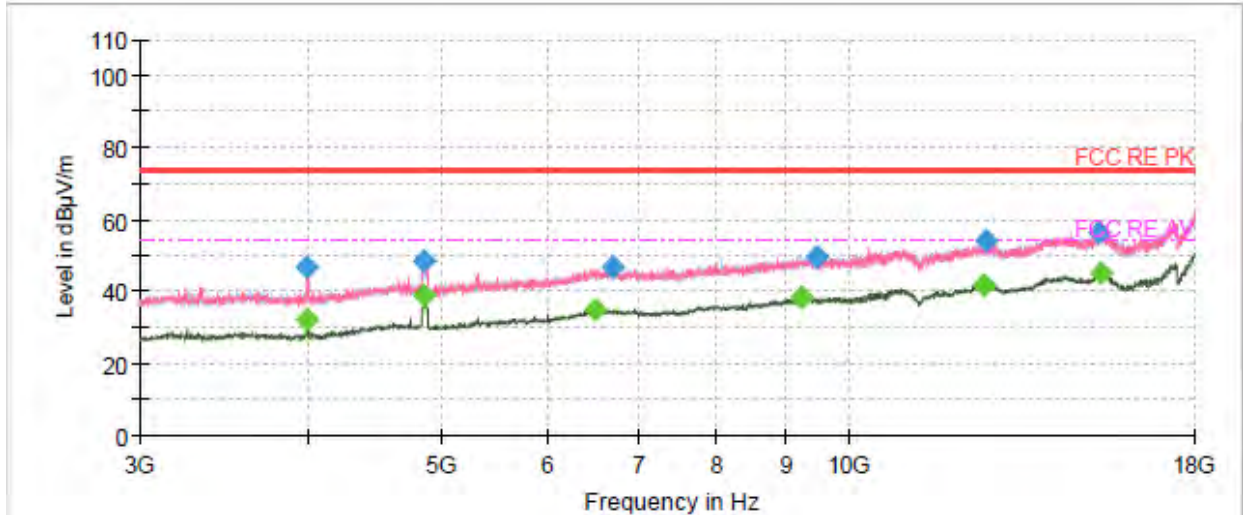

Radiates Emission from 3GHz to 18GHz

Frequency (MHz)	MaxPeak (dB µ V/m)	Average (dB µ V/m)	Limit (dB µ V/m)	Margin (dB)	Height (cm)	Pol	Azimuth (deg)	Corr. (dB/m)
3986.250000	47.10	---	74.00	26.90	200.0	V	10.0	-13.4
3986.250000	---	32.41	54.00	21.59	100.0	V	72.0	-13.4
4867.500000	48.57	---	74.00	25.43	200.0	V	346.0	-10.7
4869.375000	---	38.93	54.00	15.07	200.0	V	354.0	-10.7
6508.125000	---	35.09	54.00	18.91	200.0	V	14.0	-3.7
6695.625000	46.87	---	74.00	27.13	100.0	V	289.0	-3.5
9238.125000	---	38.51	54.00	15.49	100.0	H	15.0	-2.9
9478.125000	49.87	---	74.00	24.13	200.0	V	276.0	-2.6
12583.125000	---	41.67	54.00	12.33	200.0	V	180.0	2.2
12622.500000	54.05	---	74.00	19.95	200.0	H	83.0	2.2
15328.125000	56.33	---	74.00	17.67	100.0	H	154.0	5.7
15375.000000	---	45.09	54.00	8.91	200.0	V	0.0	5.7

Remark: 1. Correction Factor = Antenna factor+ Insertion loss (cable loss + amplifier gain)



802.11n (HT40) CH7

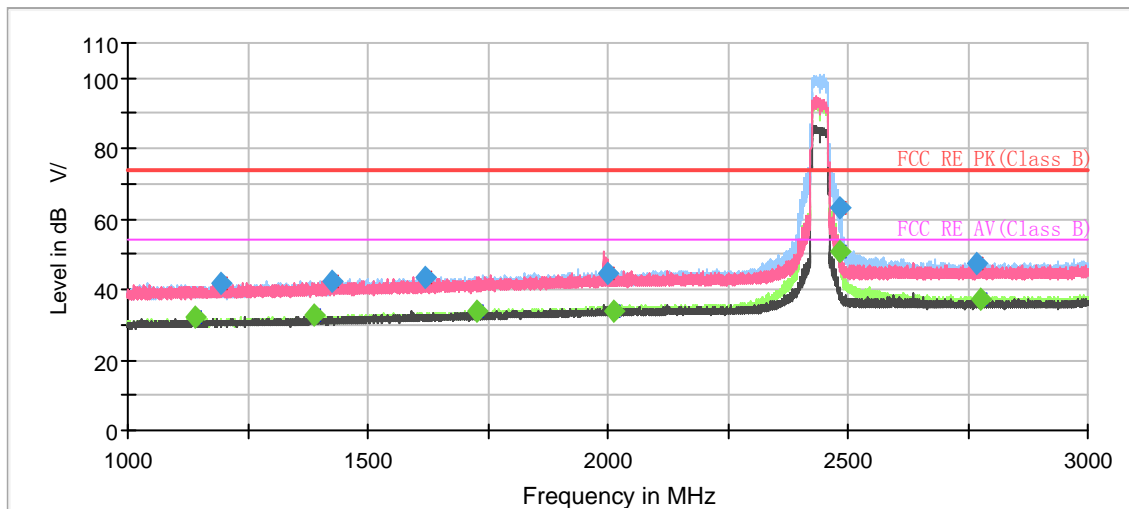

Note: The signal beyond the limit is carrier.

Radiates Emission from 1GHz to 3GHz

Frequency (MHz)	MaxPeak (dB μ V/m)	Average (dB μ V/m)	Limit (dB μ V/m)	Margin (dB)	Height (cm)	Pol	Azimuth (deg)	Corr. (dB/m)
1138.800000	---	32.09	54.00	21.91	100.0	H	316.0	-7.6
1192.200000	41.85	---	74.00	32.15	100.0	H	245.0	-7.3
1388.866667	---	32.62	54.00	21.38	200.0	H	330.0	-6.2
1426.200000	42.49	---	74.00	31.51	200.0	H	10.0	-6.0
1620.066667	43.58	---	74.00	30.42	100.0	H	22.0	-4.9
1726.333333	---	33.83	54.00	20.17	200.0	H	296.0	-4.3
2000.533333	44.77	---	74.00	29.23	100.0	H	308.0	-2.6
2013.866667	---	33.87	54.00	20.13	200.0	H	0.0	-2.6
2484.066667	---	51.02	54.00	2.98	200.0	H	88.0	-0.7
2484.466667	63.13	---	74.00	10.87	200.0	H	88.0	-0.7
2769.133333	47.48	---	74.00	26.52	200.0	H	342.0	0.8
2778.133333	---	37.21	54.00	16.79	100.0	H	268.0	0.9

Remark: 1. Correction Factor = Antenna factor+ Insertion loss (cable loss + amplifier gain)

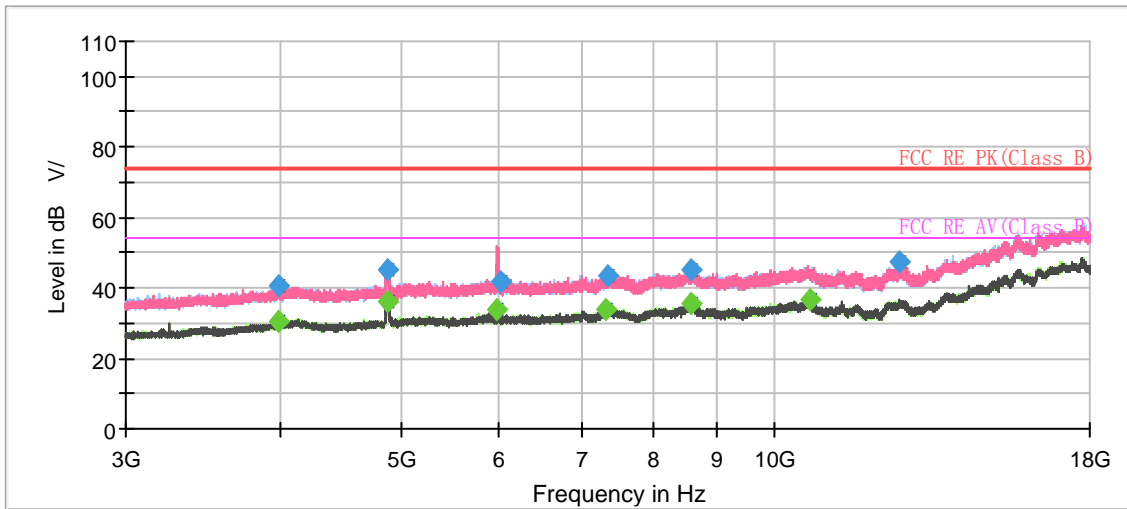

Radiates Emission from 3GHz to 18GHz

Frequency (MHz)	MaxPeak (dB μ V/m)	Average (dB μ V/m)	Limit (dB μ V/m)	Margin (dB)	Height (cm)	Pol	Azimuth (deg)	Corr. (dB/m)
3980.500000	40.51	---	74.00	33.49	200.0	V	188.0	-4.0
3991.500000	---	30.39	54.00	23.61	200.0	V	258.0	-3.9
4879.500000	44.98	---	74.00	29.02	200.0	V	160.0	-2.1
4883.000000	---	36.36	54.00	17.64	200.0	V	151.0	-2.0
5974.500000	---	34.07	54.00	19.93	100.0	V	121.0	-0.3
6021.500000	41.82	---	74.00	32.18	100.0	H	351.0	-0.3
7326.000000	---	33.75	54.00	20.25	100.0	H	3.0	1.4
7336.500000	43.55	---	74.00	30.45	100.0	V	21.0	1.4
8581.500000	44.95	---	74.00	29.05	100.0	V	121.0	4.0
8593.500000	---	35.28	54.00	18.72	200.0	H	95.0	3.9
10702.000000	---	36.91	54.00	17.09	200.0	H	318.0	5.3
12640.500000	47.31	---	74.00	26.69	100.0	V	190.0	7.4

Remark: 1. Correction Factor = Antenna factor+ Insertion loss (cable loss + amplifier gain)



802.11n (HT40) CH8

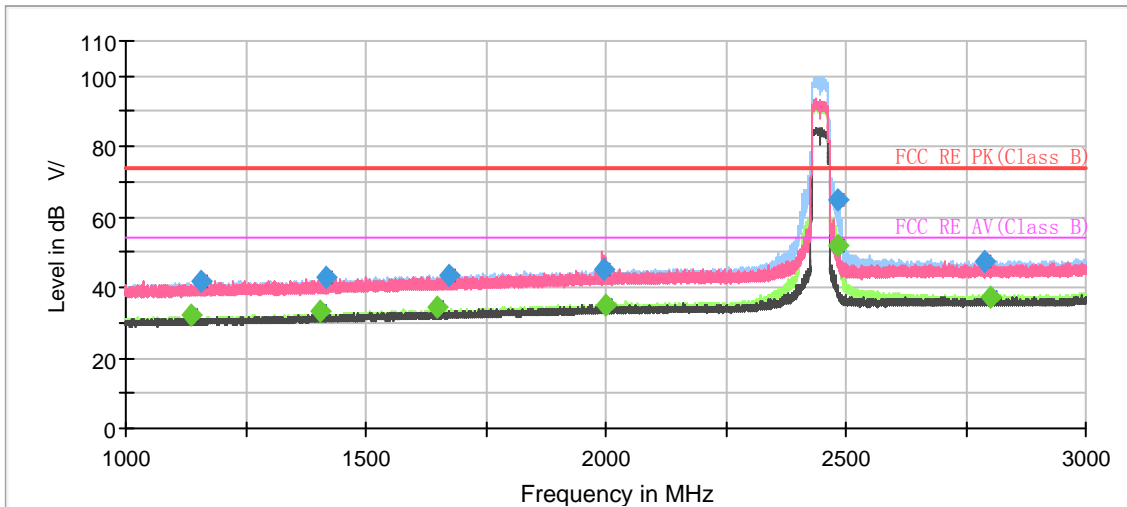

Note: The signal beyond the limit is carrier.

Radiates Emission from 1GHz to 3GHz

Frequency (MHz)	MaxPeak (dB μ V/m)	Average (dB μ V/m)	Limit (dB μ V/m)	Margin (dB)	Height (cm)	Pol	Azimuth (deg)	Corr. (dB/m)
1134.866667	---	32.14	54.00	21.86	200.0	V	204.0	-7.6
1158.866667	41.82	---	74.00	32.18	200.0	H	39.0	-7.5
1404.933333	---	33.44	54.00	20.56	100.0	H	297.0	-6.1
1417.600000	42.62	---	74.00	31.38	200.0	V	276.0	-6.1
1650.600000	---	34.27	54.00	19.73	200.0	H	15.0	-4.8
1675.533333	43.65	---	74.00	30.35	100.0	H	289.0	-4.6
1996.400000	45.26	---	74.00	28.74	100.0	H	344.0	-2.7
1998.866667	---	34.90	54.00	19.10	100.0	H	281.0	-2.7
2484.666667	---	51.74	54.00	2.26	100.0	H	184.0	-0.7
2484.866667	64.74	---	74.00	9.26	100.0	H	176.0	-0.7
2790.800000	47.11	---	74.00	26.89	100.0	H	313.0	0.9
2801.400000	---	37.20	54.00	16.80	200.0	H	62.0	0.9

Remark: 1. Correction Factor = Antenna factor+ Insertion loss (cable loss + amplifier gain)

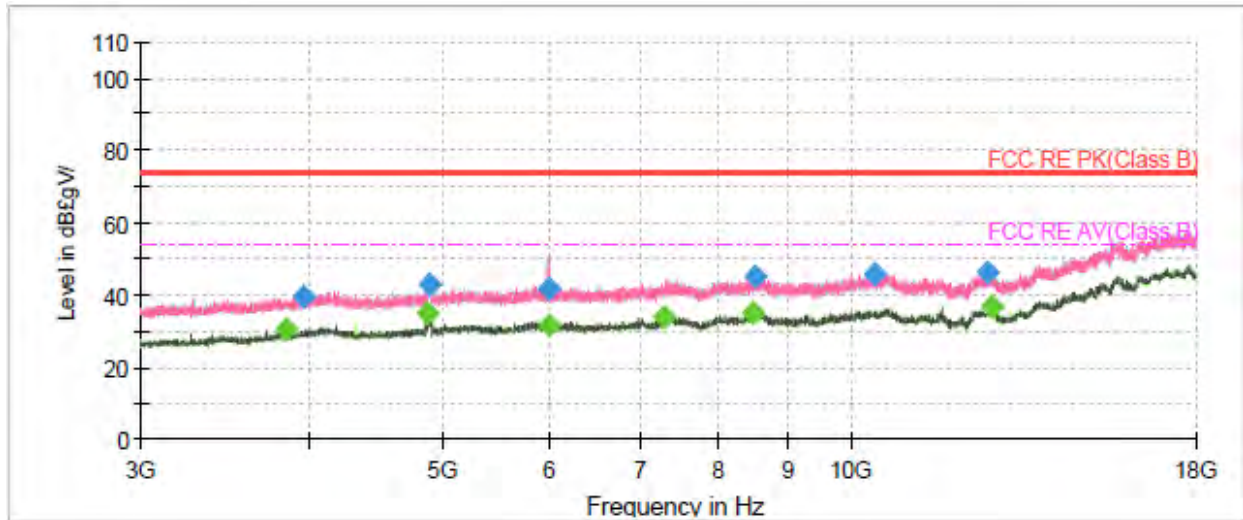

Radiates Emission from 3GHz to 18GHz

Frequency (MHz)	MaxPeak (dB µ V/m)	Average (dB µ V/m)	Limit (dB µ V/m)	Margin (dB)	Height (cm)	Pol	Azimuth (deg)	Corr. (dB/m)
3843.000000	---	30.41	54.00	23.59	100.0	V	166.0	-4.8
3961.000000	39.72	---	74.00	34.28	200.0	H	246.0	-4.1
4885.000000	---	35.15	54.00	18.85	200.0	V	159.0	-2.0
4900.000000	42.78	---	74.00	31.22	100.0	V	202.0	-1.9
5991.000000	---	31.81	54.00	22.19	100.0	H	339.0	-0.3
6006.500000	41.61	---	74.00	32.39	100.0	V	318.0	-0.3
7284.500000	---	33.61	54.00	20.39	100.0	V	4.0	1.3
8498.000000	---	34.96	54.00	19.04	100.0	H	200.0	3.8
8509.000000	45.14	---	74.00	28.86	100.0	V	84.0	3.9
10433.000000	45.57	---	74.00	28.43	100.0	V	255.0	5.9
12649.000000	46.11	---	74.00	27.89	200.0	H	0.0	7.4
12739.000000	---	36.41	54.00	17.59	200.0	V	186.0	7.5

Remark: 1. Correction Factor = Antenna factor+ Insertion loss (cable loss + amplifier gain)



802.11n (HT40) CH9

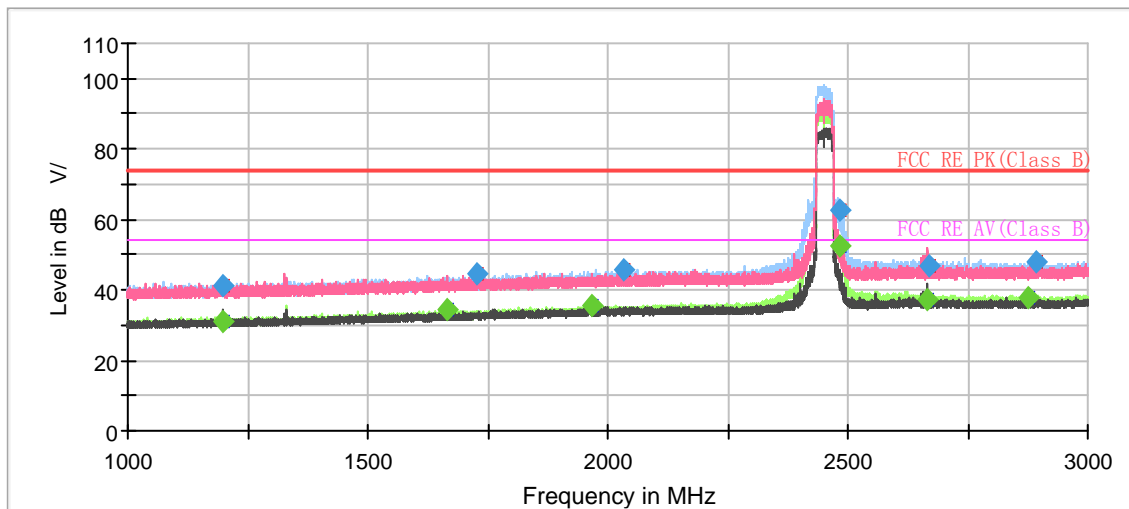

Note: The signal beyond the limit is carrier.

Radiates Emission from 1GHz to 3GHz

Frequency (MHz)	MaxPeak (dB μ V/m)	Average (dB μ V/m)	Limit (dB μ V/m)	Margin (dB)	Height (cm)	Pol	Azimuth (deg)	Corr. (dB/m)
1197.600000	41.01	---	74.00	32.99	200.0	H	81.0	-7.3
1199.933333	---	31.15	54.00	22.85	200.0	H	57.0	-7.3
1664.533333	---	34.37	54.00	19.63	200.0	V	24.0	-4.7
1725.333333	44.78	---	74.00	29.22	200.0	V	151.0	-4.3
1968.266667	---	35.65	54.00	18.35	100.0	H	294.0	-2.9
2033.600000	45.85	---	74.00	28.15	100.0	H	357.0	-2.5
2484.533333	62.72	---	74.00	11.28	200.0	H	290.0	-0.7
2484.800000	---	52.66	54.00	1.34	100.0	H	0.0	-0.7
2664.666667	---	37.12	54.00	16.88	100.0	H	244.0	0.4
2667.600000	47.09	---	74.00	26.91	100.0	H	53.0	0.4
2877.933333	---	37.80	54.00	16.20	100.0	H	61.0	1.2
2892.000000	47.85	---	74.00	26.15	200.0	H	226.0	1.2

Remark: 1. Correction Factor = Antenna factor+ Insertion loss (cable loss + amplifier gain)

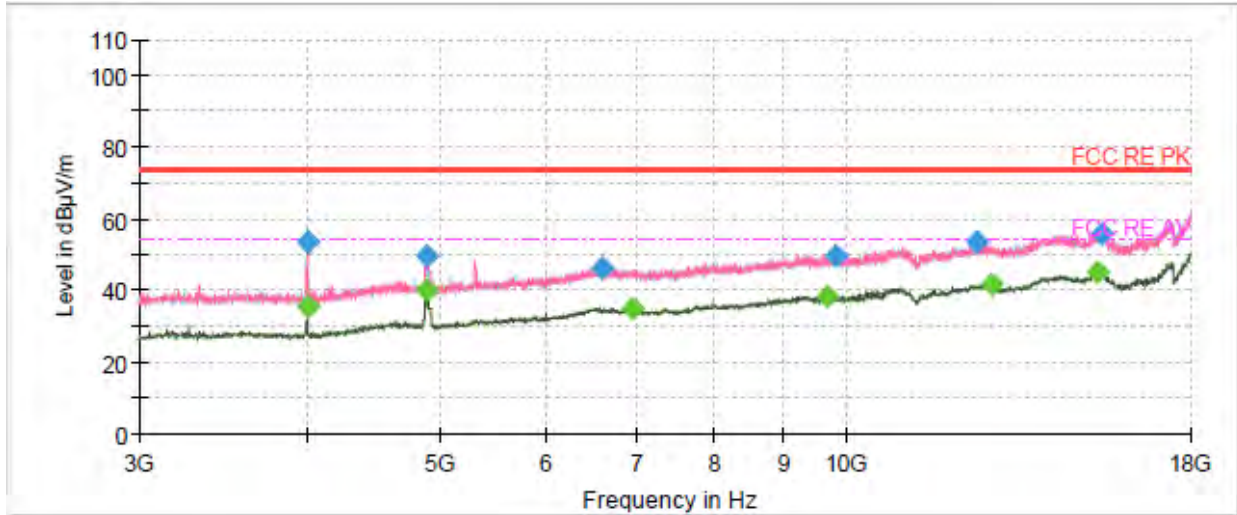

Radiates Emission from 3GHz to 18GHz

Frequency (MHz)	MaxPeak (dB µ V/m)	Average (dB µ V/m)	Limit (dB µ V/m)	Margin (dB)	Height (cm)	Pol	Azimuth (deg)	Corr. (dB/m)
3995.625000	53.48	---	74.00	20.52	100.0	V	66.0	-13.3
3995.625000	---	35.31	54.00	18.69	100.0	V	66.0	-13.3
4901.250000	---	39.98	54.00	14.02	200.0	V	12.0	-10.7
4903.125000	49.54	---	74.00	24.46	200.0	V	17.0	-10.7
6600.000000	46.53	---	74.00	27.47	200.0	H	262.0	-3.6
6965.625000	---	35.21	54.00	18.79	100.0	H	89.0	-3.8
9699.375000	---	38.43	54.00	15.57	100.0	V	304.0	-2.5
9826.875000	49.83	---	74.00	24.17	200.0	V	98.0	-1.8
12491.250000	53.80	---	74.00	20.20	100.0	H	0.0	1.9
12810.000000	---	41.68	54.00	12.32	200.0	V	144.0	2.1
15350.625000	---	45.03	54.00	8.97	100.0	V	172.0	5.8
15472.500000	55.99	---	74.00	18.01	100.0	V	257.0	5.3

Remark: 1. Correction Factor = Antenna factor+ Insertion loss (cable loss + amplifier gain)

Bluetooth LE-Channel 0

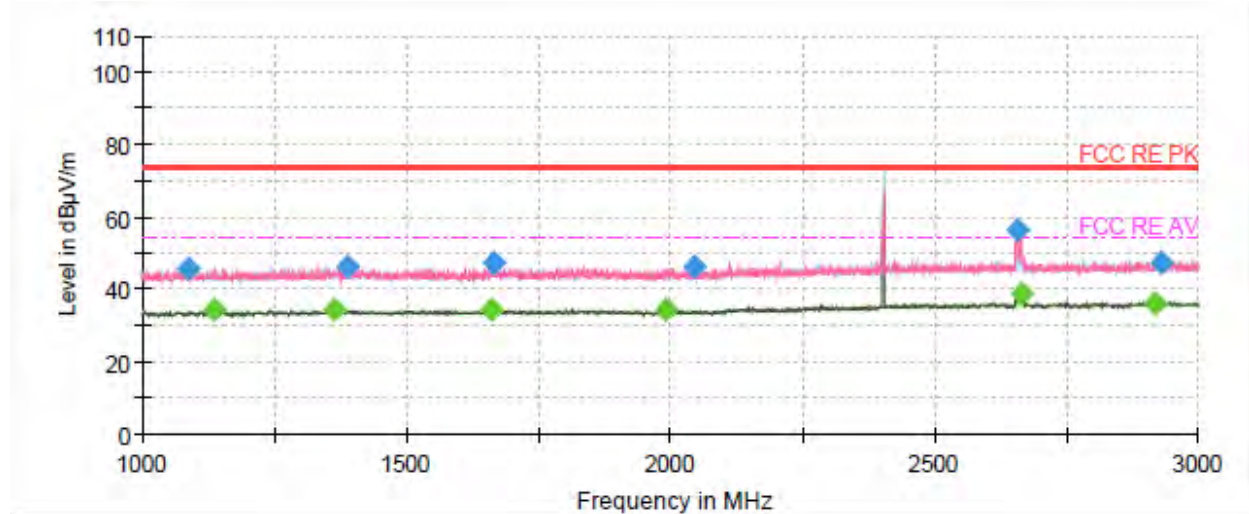

Note: The signal beyond the limit is carrier.
Radiates Emission from 1GHz to 3GHz

Frequency (MHz)	MaxPeak (dB µ V/m)	Average (dB µ V/m)	Limit (dB µ V/m)	Margin (dB)	Height (cm)	Pol	Azimuth (deg)	Corr. (dB/m)
1088.750000	45.94	---	74.00	28.06	200.0	V	0.0	-10.7
1136.000000	---	34.15	54.00	19.85	100.0	H	174.0	-10.5
1365.500000	---	34.35	54.00	19.65	100.0	V	73.0	-9.6
1387.500000	46.03	---	74.00	27.97	100.0	H	217.0	-9.6
1662.250000	---	34.50	54.00	19.50	200.0	V	34.0	-8.8
1666.500000	47.23	---	74.00	26.77	100.0	V	350.0	-8.8
1993.250000	---	34.43	54.00	19.58	200.0	H	194.0	-8.2
2047.000000	46.23	---	74.00	27.77	200.0	H	350.0	-8.0
2656.500000	56.30	---	74.00	17.70	100.0	V	295.0	-6.1
2663.750000	---	39.18	54.00	14.82	100.0	V	329.0	-6.0
2915.500000	---	36.26	54.00	17.74	200.0	H	311.0	-6.1
2928.000000	47.16	---	74.00	26.84	200.0	V	0.0	-6.0

Remark: 1. Correction Factor = Antenna factor+ Insertion loss (cable loss + amplifier gain)

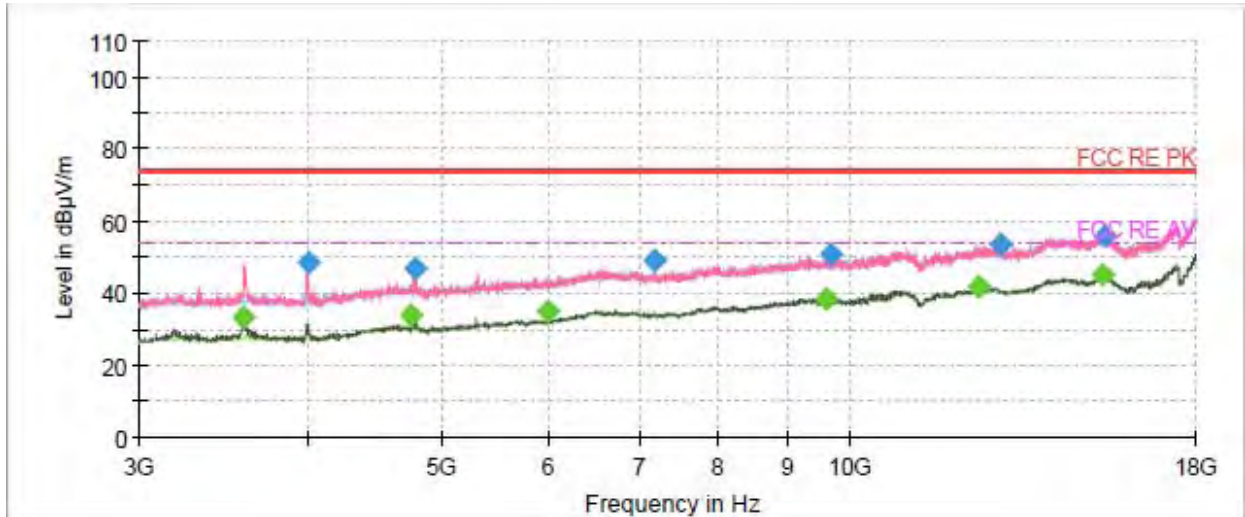

Radiates Emission from 3GHz to 18GHz

Frequency (MHz)	MaxPeak (dB µ V/m)	Average (dB µ V/m)	Limit (dB µ V/m)	Margin (dB)	Height (cm)	Pol	Azimuth (deg)	Corr. (dB/m)
3585.000000	---	33.14	54.00	20.86	200.0	V	288.0	-14.4
3999.375000	48.31	---	74.00	25.69	100.0	V	202.0	-13.3
4762.500000	---	33.99	54.00	20.01	200.0	V	269.0	-10.6
4798.125000	47.05	---	74.00	26.95	100.0	V	153.0	-10.6
5996.250000	---	35.08	54.00	18.92	200.0	V	259.0	-6.9
7185.000000	49.24	---	74.00	24.76	100.0	V	212.0	-4.4
9611.250000	---	38.54	54.00	15.46	100.0	V	289.0	-2.3
9676.875000	50.52	---	74.00	23.48	100.0	H	236.0	-2.4
12436.875000	---	41.65	54.00	12.35	200.0	V	0.0	1.7
12909.375000	53.44	---	74.00	20.56	200.0	V	2.0	1.9
15373.125000	---	45.09	54.00	8.91	100.0	H	27.0	5.7
15429.375000	55.98	---	74.00	18.02	100.0	V	358.0	5.5

Remark: 1. Correction Factor = Antenna factor+ Insertion loss (cable loss + amplifier gain)

Bluetooth LE-Channel 19

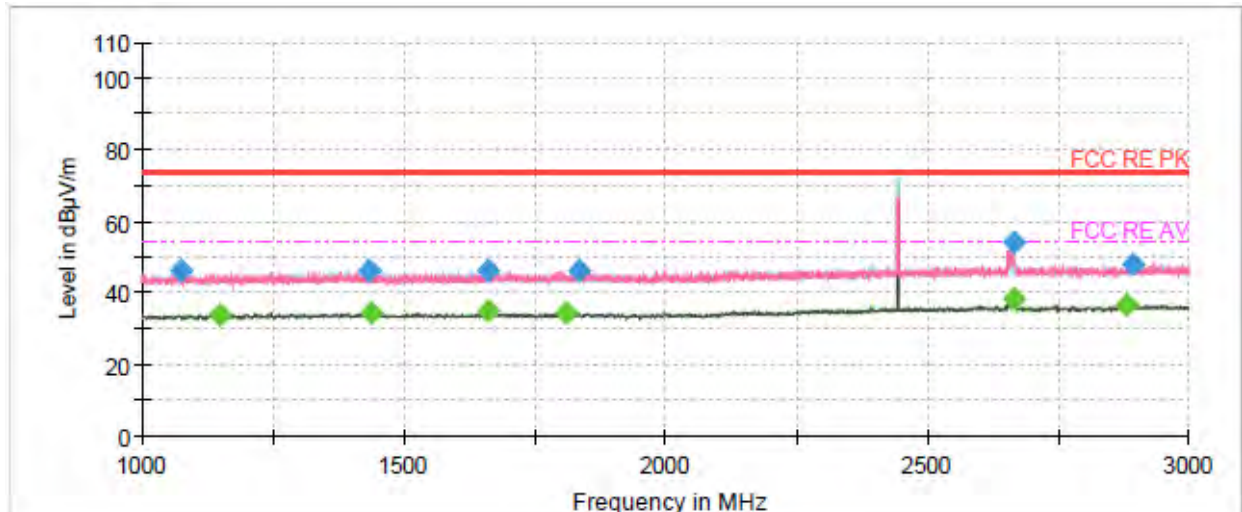

Note: The signal beyond the limit is carrier.

Radiates Emission from 1GHz to 3GHz

Frequency (MHz)	MaxPeak (dB µ V/m)	Average (dB µ V/m)	Limit (dB µ V/m)	Margin (dB)	Height (cm)	Pol	Azimuth (deg)	Corr. (dB/m)
1073.500000	46.32	---	74.00	27.68	100.0	H	29.0	-10.8
1149.750000	---	34.02	54.00	19.98	100.0	V	245.0	-10.4
1432.250000	46.17	---	74.00	27.83	100.0	H	22.0	-9.3
1437.500000	---	34.51	54.00	19.49	200.0	V	12.0	-9.3
1661.750000	---	34.94	54.00	19.06	200.0	H	297.0	-8.8
1661.750000	46.21	---	74.00	27.79	200.0	H	297.0	-8.8
1811.500000	---	34.52	54.00	19.48	200.0	H	355.0	-8.5
1835.500000	46.43	---	74.00	27.57	200.0	H	354.0	-8.5
2663.500000	---	38.53	54.00	15.47	100.0	V	162.0	-6.0
2663.500000	54.11	---	74.00	19.89	100.0	V	162.0	-6.0
2881.750000	---	36.44	54.00	17.56	100.0	V	342.0	-6.0
2892.250000	48.15	---	74.00	25.85	200.0	V	228.0	-6.0

Remark: 1. Correction Factor = Antenna factor+ Insertion loss (cable loss + amplifier gain)

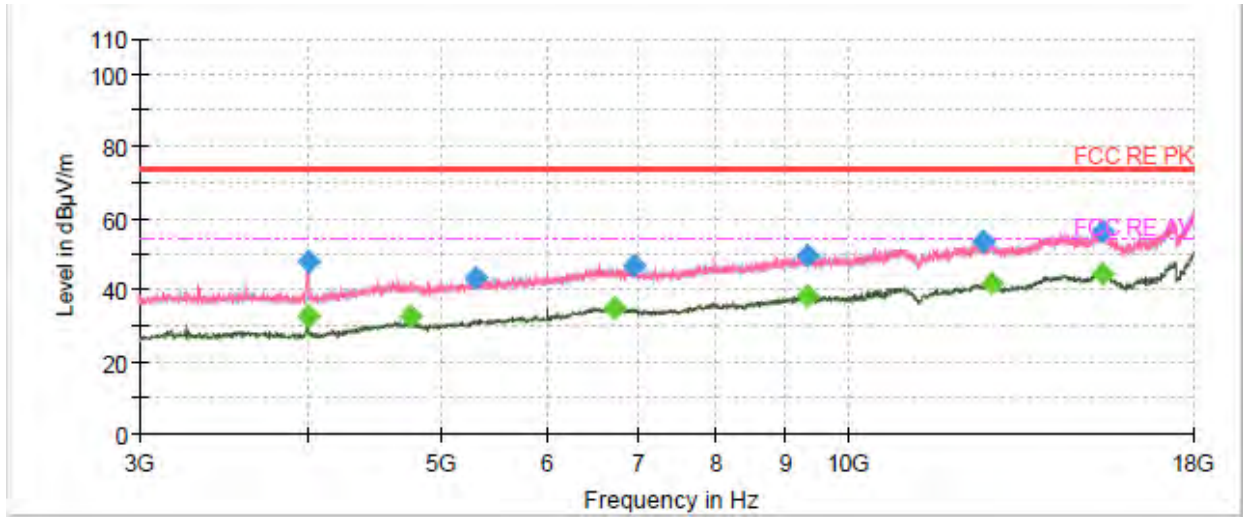

Radiates Emission from 3GHz to 18GHz

Frequency (MHz)	MaxPeak (dB µ V/m)	Average (dB µ V/m)	Limit (dB µ V/m)	Margin (dB)	Height (cm)	Pol	Azimuth (deg)	Corr. (dB/m)
3995.625000	47.95	---	74.00	26.05	100.0	V	62.0	-13.3
3995.625000	---	32.64	54.00	21.36	100.0	V	62.0	-13.3
4762.500000	---	32.75	54.00	21.25	200.0	V	289.0	-10.6
5310.000000	43.59	---	74.00	30.41	200.0	H	229.0	-9.0
6733.125000	---	35.09	54.00	18.91	100.0	H	326.0	-3.6
6963.750000	46.82	---	74.00	27.18	100.0	H	18.0	-3.8
9326.250000	49.71	---	74.00	24.29	100.0	V	320.0	-2.8
9346.875000	---	38.59	54.00	15.41	200.0	H	355.0	-2.7
12600.000000	53.65	---	74.00	20.35	200.0	V	38.0	2.2
12781.875000	---	41.69	54.00	12.31	200.0	V	11.0	2.2
15393.750000	---	44.79	54.00	9.21	100.0	H	1.0	5.6
15423.750000	56.29	---	74.00	17.71	100.0	V	356.0	5.5

Remark: 1. Correction Factor = Antenna factor+ Insertion loss (cable loss + amplifier gain)

Bluetooth LE-Channel 39

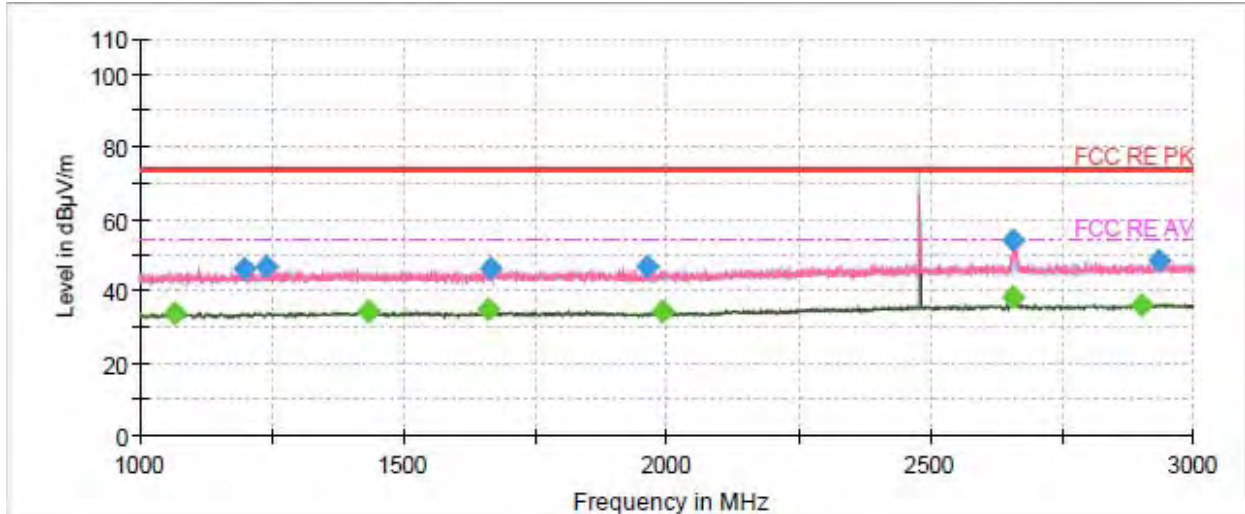

Note: The signal beyond the limit is carrier.
Radiates Emission from 1GHz to 3GHz

Frequency (MHz)	MaxPeak (dB µ V/m)	Average (dB µ V/m)	Limit (dB µ V/m)	Margin (dB)	Height (cm)	Pol	Azimuth (deg)	Corr. (dB/m)
1067.750000	---	33.93	54.00	20.07	200.0	V	1.0	-10.9
1197.500000	46.23	---	74.00	27.77	200.0	V	93.0	-10.3
1240.750000	46.72	---	74.00	27.28	200.0	V	85.0	-10.0
1434.000000	---	34.42	54.00	19.58	200.0	V	286.0	-9.3
1660.500000	---	35.10	54.00	18.90	200.0	H	301.0	-8.8
1664.000000	46.37	---	74.00	27.63	200.0	V	34.0	-8.8
1964.250000	46.93	---	74.00	27.07	100.0	V	333.0	-8.4
1992.500000	---	34.53	54.00	19.47	100.0	H	144.0	-8.2
2658.000000	---	38.61	54.00	15.39	200.0	V	4.0	-6.0
2658.000000	54.40	---	74.00	19.60	200.0	V	4.0	-6.0
2899.500000	---	36.22	54.00	17.78	200.0	V	68.0	-6.0
2932.250000	48.24	---	74.00	25.76	100.0	H	50.0	-6.0

Remark: 1. Correction Factor = Antenna factor+ Insertion loss (cable loss + amplifier gain)

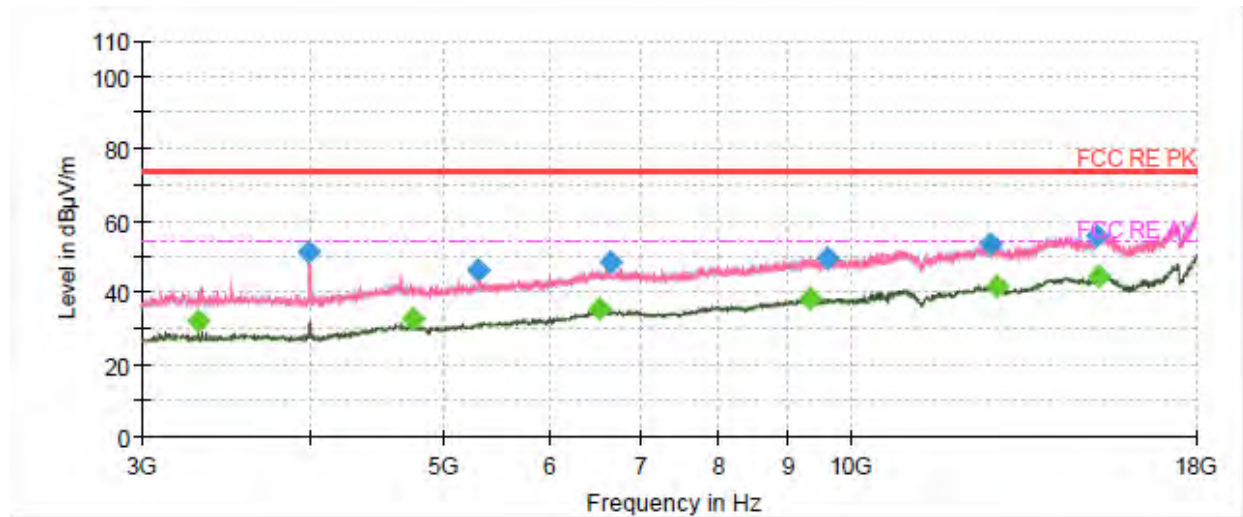

Radiates Emission from 3GHz to 18GHz

Frequency (MHz)	MaxPeak (dB μ V/m)	Average (dB μ V/m)	Limit (dB μ V/m)	Margin (dB)	Height (cm)	Pol	Azimuth (deg)	Corr. (dB/m)
3305.625000	---	32.06	54.00	21.94	100.0	V	294.0	-15.1
3982.500000	51.40	---	74.00	22.60	100.0	V	198.0	-13.4
4762.500000	---	32.53	54.00	21.47	200.0	V	268.0	-10.6
5315.625000	46.21	---	74.00	27.79	200.0	V	220.0	-8.9
6519.375000	---	35.57	54.00	18.43	200.0	V	7.0	-3.7
6663.750000	48.78	---	74.00	25.22	100.0	V	304.0	-3.5
9326.250000	---	38.50	54.00	15.50	200.0	H	243.0	-2.8
9616.875000	49.89	---	74.00	24.11	200.0	V	28.0	-2.3
12703.125000	53.45	---	74.00	20.55	200.0	V	298.0	2.3
12808.125000	---	41.74	54.00	12.26	100.0	V	246.0	2.1
15204.375000	56.05	---	74.00	17.95	200.0	V	7.0	5.3
15249.375000	---	44.71	54.00	9.29	100.0	H	14.0	5.5

Remark: 1. Correction Factor = Antenna factor+ Insertion loss (cable loss + amplifier gain)

During the test, the Radiates Emission from 18GHz to 26GHz was performed in all modes with all channels, 802.11n (HT40) CH3 are selected as the worst condition. The test data of the worst-case condition was recorded in this report.

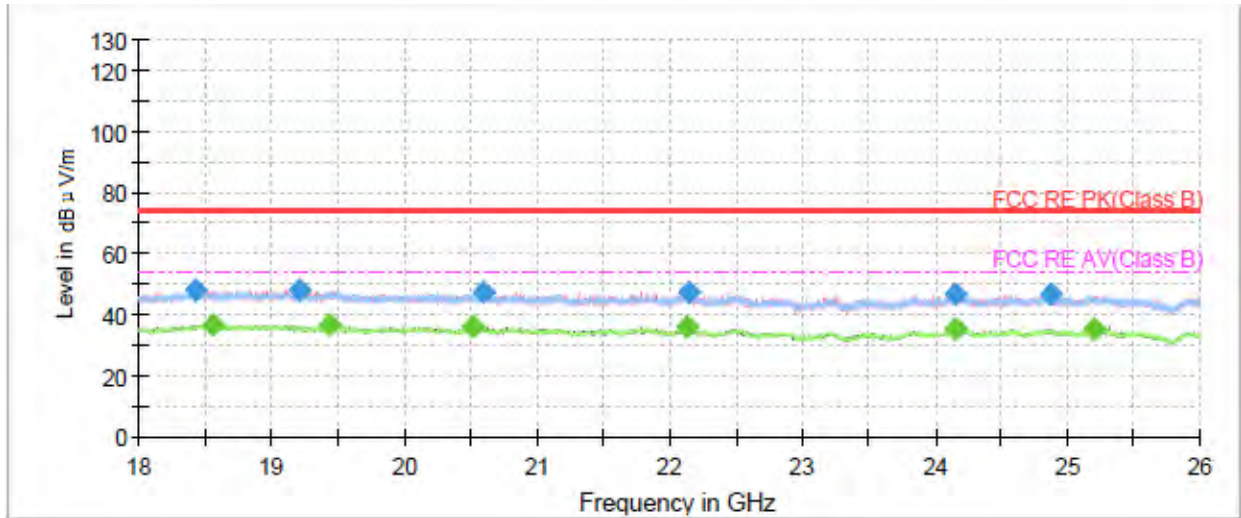

Radiates Emission from 18GHz to 26GHz

5.7. Conducted Emission

Ambient condition

Temperature	Relative humidity	Pressure
23°C ~25°C	45%~50%	101.5kPa

Methods of Measurement

The EUT is placed on a non-metallic table of 80cm height above the horizontal metal reference ground plane. During the test, the EUT was operating in its typical mode. The test method is according to ANSI C63.10. Connect the AC power line of the EUT to the L.I.S.N. Use EMI receiver to detect the average and Quasi-peak value. RBW is set to 9 kHz, VBW is set to 30kHz.

The measurement result should include both L line and N line.

The test is in transmitting mode.

Test Setup

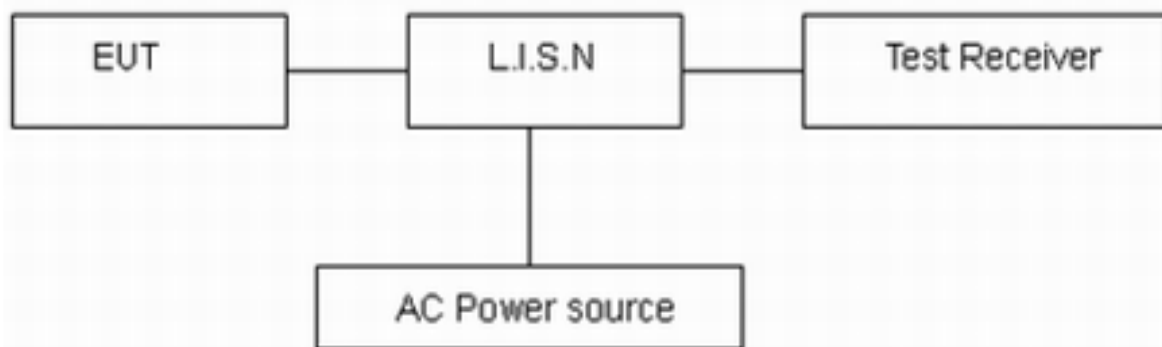

Note: AC Power source is used to change the voltage 110V/60Hz.

Limits

Frequency (MHz)	Conducted Limits(dBμV)	
	Quasi-peak	Average
0.15 - 0.5	66 to 56 *	56 to 46 *
0.5 - 5	56	46
5 - 30	60	50

*: Decreases with the logarithm of the frequency.

Measurement Uncertainty

The assessed measurement uncertainty to ensure 95% confidence level for the normal distribution is with the coverage factor $k = 1.96$, $U = 2.69$ dB.

Test Results:

Following plots, Blue trace uses the peak detection and Green trace uses the average detection. During the test, the Conducted Emission was performed in all modes (WIFI 2.4G /Bluetooth LE) with all channels, 802.11n (HT40) CH3 are selected as the worst condition. The test data of the worst-case condition was recorded in this report.

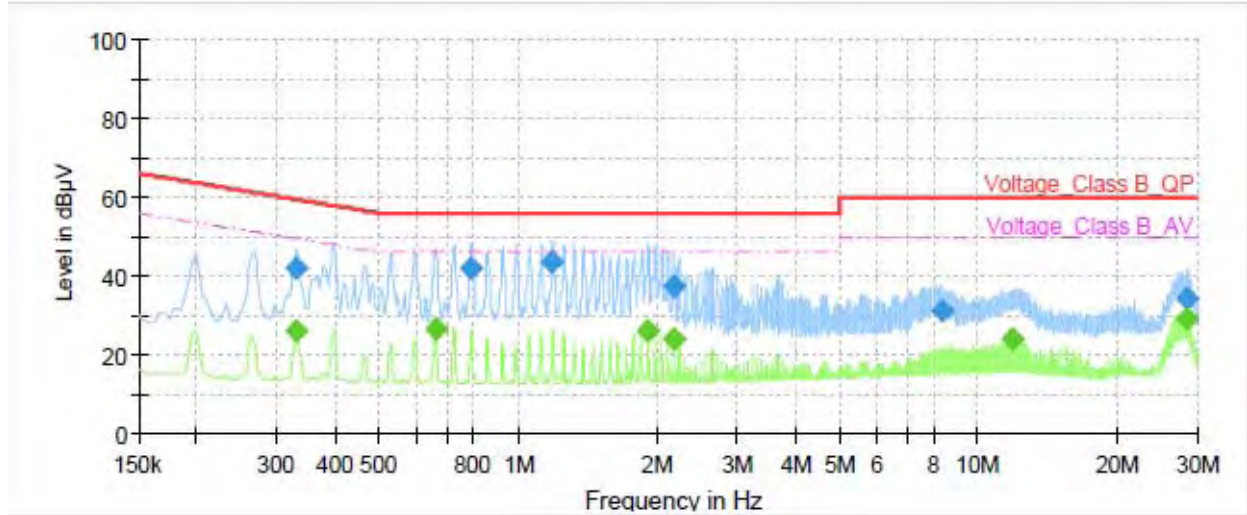

Frequency (MHz)	QuasiPeak (dBµV)	Average (dBµV)	Limit (dBµV)	Margin (dB)	Meas. Time (ms)	Bandwidth (kHz)	Line	Filter	Corr. (dB)
0.33	---	26.30	49.45	23.15	70.0	9.000	L1	ON	21
0.33	41.82	---	59.45	17.63	70.0	9.000	L1	ON	21
0.66	---	26.46	46.00	19.54	70.0	9.000	L1	ON	20
0.79	42.10	---	56.00	13.90	70.0	9.000	L1	ON	20
1.19	43.38	---	56.00	12.62	70.0	9.000	L1	ON	20
1.91	---	26.12	46.00	19.88	70.0	9.000	L1	ON	20
2.18	---	24.19	46.00	21.81	70.0	9.000	L1	ON	20
2.18	37.47	---	56.00	18.53	70.0	9.000	L1	ON	20
8.38	31.39	---	60.00	28.61	70.0	9.000	L1	ON	20
11.87	---	24.07	50.00	25.93	70.0	9.000	L1	ON	20
28.48	34.58	---	60.00	25.42	70.0	9.000	L1	ON	20
28.52	---	29.41	50.00	20.59	70.0	9.000	L1	ON	20

Remark: Correct factor=cable loss + LISN factor

L line Conducted Emission from 150 KHz to 30 MHz

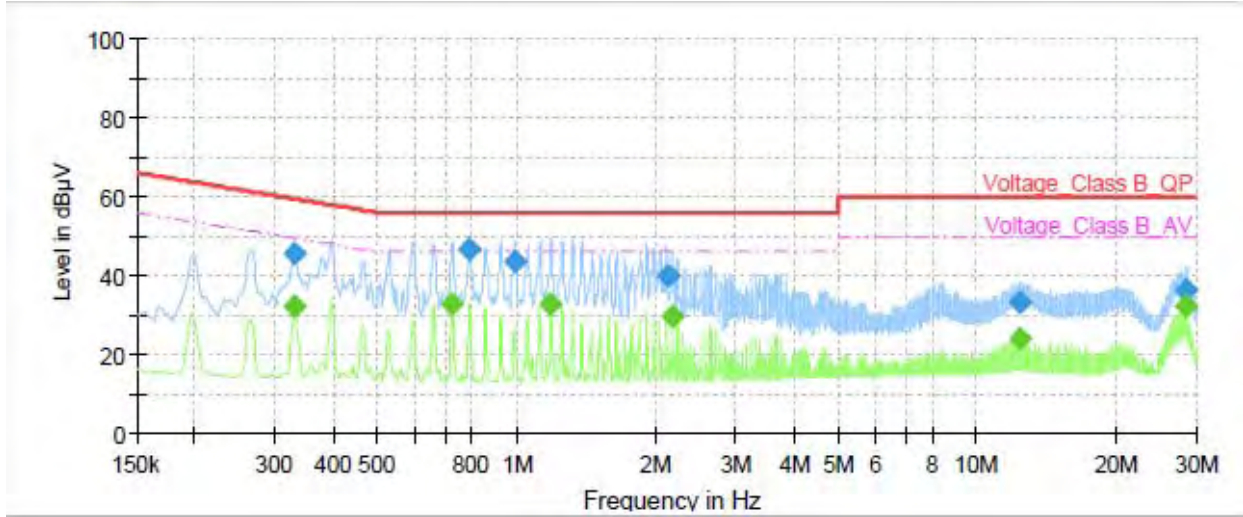

Frequency (MHz)	QuasiPeak (dBµV)	Average (dBµV)	Limit (dBµV)	Margin (dB)	Meas. Time (ms)	Bandwidth (kHz)	Line	Filter	Corr. (dB)
0.33	---	32.07	49.45	17.38	70.0	9.000	N	ON	21
0.33	45.65	---	59.45	13.80	70.0	9.000	N	ON	21
0.73	---	32.94	46.00	13.06	70.0	9.000	N	ON	20
0.79	46.44	---	56.00	9.56	70.0	9.000	N	ON	20
0.99	43.70	---	56.00	12.30	70.0	9.000	N	ON	20
1.19	---	32.77	46.00	13.23	70.0	9.000	N	ON	20
2.12	40.00	---	56.00	16.00	70.0	9.000	N	ON	20
2.18	---	29.93	46.00	16.07	70.0	9.000	N	ON	20
12.40	33.32	---	60.00	26.68	70.0	9.000	N	ON	20
12.40	---	24.07	50.00	25.93	70.0	9.000	N	ON	20
28.52	---	32.34	50.00	17.66	70.0	9.000	N	ON	20
28.56	36.24	---	60.00	23.76	70.0	9.000	N	ON	20

Remark: Correct factor=cable loss + LISN factor

N line Conducted Emission from 150 KHz to 30 MHz



6. Main Test Instruments

Name	Manufacturer	Type	Serial Number	Calibration Date	Expiration Date
Spectrum Analyzer	R&S	FSV30	100815	2020-12-13	2021-12-12
EMI Test Receiver	R&S	ESCI	100948	2020-05-18	2021-05-17
				2021-05-15	2022-05-14
Loop Antenna	SCHWARZBECK	FMZB1519	1519-047	2020-04-02	2023-04-01
TRILOG Broadband Antenna	SCHWARZBECK	VULB 9163	391	2019-12-16	2021-12-15
Horn Antenna	R&S	HF907	102723	2018-08-11	2021-08-10
Horn Antenna	ETS-Lindgren	3160-09	00102643	2018-06-20	2021-06-19
EMI Test Receiver	R&S	ESR	101667	2020-05-18	2021-05-17
				2021-05-16	2022-05-15
LISN	R&S	ENV216	101171	2018-12-15	2021-12-14
Spectrum Analyzer	Agilent	N9010A	MY47191109	2020-05-18	2021-05-17
				2021-05-15	2022-05-14
Power Meter	R&S	NRP2	104306	2020-05-18	2021-05-17
				2021-05-15	2022-05-14
Power Sensor	R&S	NRP-Z21	104799	2020-05-18	2021-05-17
				2021-05-15	2022-05-14
RF Cable	Agilent	SMA 15cm	0001	2020-12-10	2021-06-09
Software	R&S	EMC32	9.26.0	/	/

*****END OF REPORT *****



ANNEX A: The EUT Appearance

The EUT Appearance are submitted separately.



ANNEX B: Test Setup Photos

The Test Setup Photos are submitted separately.