

## RESOLUCION 737 - SUBTEL

Fecha de publicación: 10/3/2026

---

### Información Comercial

#### Nombre comercial del equipo

Código	Descripción
929002685112	SuperSlim WiZ Ceiling 16W W RD 27-65K TW

**Fabricante:** Signify (China) Investment Co., Ltd.

**Importador o representante en Chile:** SIGNIFY CHILENA S.A.

**Domicilio:** El Bosque Norte 0211, Las Condes - Santiago

**Correo electrónico de contacto:** tomas.aragona@signify.com

**Sitio Web:** wizconnected.com/es-cl

---

### Características técnicas

Tipo de equipo	Luminaria LED
Marca	WIZ
Modelo	SuperSlim WiZ Ceiling 16W W RD 27-65K TW
Módulo	ESP32-C3-WIZ2012
Tecnología o modulación	DSSS, OFDM, GFSK
Frecuencias	BLE: 2402 – 2480 MHz; WLAN: 2412-2462 MHz.
Ganancia de antena (dBi)	5.19 dBi
P.I.R.E. (EIRP)	BLE: 8,26 mW (9,17 dBm); WLAN 2G: 304,78 mW (24,84 dBm).

---

### Declaración de conformidad

*“El equipo previamente individualizado cumple con las disposiciones establecidas en la Norma Técnica de Equipos de alcance reducido, aprobada por la resolución exenta N° 1.985, de 2017, de la Subsecretaría de Telecomunicaciones.”*

---

Firma del Importador/Responsable:

Nombre de quien firma: Tomás Aragona



Cargo: Representante Legal

/DO N° 104.151/F23

- ANT.: 1. Ingreso SUBTEL N° 174.625 de 05.12.2023.  
2. Resolución Exenta N° 1985 de 2017, y sus modificaciones, de la Subsecretaría de Telecomunicaciones  
3. Resolución Exenta N° 3.103 de 2012, de la Subsecretaría de Telecomunicaciones.  
4. Resolución Exenta N° 470 de fecha 13.02.2013, que faculta a los jefes de División y de Departamento para firmar "Por Orden del Subsecretario de Telecomunicaciones" y delega las facultades que indica.

MAT.: Certifica equipo de alcance reducido.

DE: SUBSECRETARÍA DE TELECOMUNICACIONES

A: MB SERVICES

- De acuerdo a la información proporcionada por documento de ANT. 1), esta Subsecretaría de Estado extiende el presente certificado para operar dentro del país, condicionado al estricto cumplimiento de lo señalado en letra j.1), del artículo 1° de la norma señalada en ANT. 2):
  - Tipo de Equipo : Luminaria LED
  - Marca : WIZ
  - Modelo : SuperSlim WIZ Ceiling 16W W RD 27-65K TW
  - Fabricante : Signify (China) Investment Co., Ltd.
  - Frecuencias de operación : BLE: 2402-2480 MHz; WLAN: 2412-2462 MHz.
  - Potencia máxima radiada : BLE: 8,26 mW (9,17 dBm); WLAN 2,4G: 304,78 mW (24,84 dBm).
  - Restricciones : Estos equipos deben operar al interior de recintos cerrados.
- El incumplimiento de lo dispuesto por el presente certificado, será sancionado de acuerdo a las disposiciones legales vigentes. Estos equipos no deberán provocar interferencias a servicios de concesionarias de telecomunicaciones y no estarán protegidos respecto de interferencias que eventualmente puedan recibir.

Saluda atentamente a Ud.,  
Por orden del Subsecretario de Telecomunicaciones

**DISTRIBUCIÓN:**

- MB Services: [ignacio.ortega@mbservices.cl](mailto:ignacio.ortega@mbservices.cl) , [laboratorio@mbservices.cl](mailto:laboratorio@mbservices.cl)
- Oficina de Partes.

Raul Ignacio Dominguez Bastidas  
Jefe División Fiscalización  
15 de ene. de 2024 / 6:40:57 PM





**FCC 47 CFR PART 15 SUBPART C  
ISED RSS-247 Issue 2**

**CERTIFICATION TEST REPORT**

*For*

**2.4GHz Wi-Fi/ Bluetooth module**

**MODEL NUMBER: ESP32-C3-WIZ2012**

**PROJECT NUMBER: 4789839465**

**REPORT NUMBER: 4789839465-2**

**FCC ID: 2AGBW-WIZ2012**

**IC: 20812-WIZ2012**

**ISSUE DATE: May. 19, 2021**

*Prepared for*

**Signify (China) Investment Co., Ltd**

*Prepared by*

**UL-CCIC COMPANY LIMITED**

**No. 2, Chengwan Road, Suzhou Industrial Park, People's Republic of China**

**Tel: +86 512-6808 6400**

**Fax: +86 512-6808 4099**

**Website: [www.ul.com](http://www.ul.com)**



Revision History

<u>Rev.</u>	<u>Issue Date</u>	<u>Revisions</u>	<u>Revised By</u>
V0	05/19/2021	Initial Issue	



## TABLE OF CONTENTS

<b>1. ATTESTATION OF TEST RESULTS .....</b>	<b>4</b>
<b>2. TEST METHODOLOGY .....</b>	<b>6</b>
<b>3. FACILITIES AND ACCREDITATION .....</b>	<b>6</b>
<b>4. CALIBRATION AND UNCERTAINTY .....</b>	<b>7</b>
4.1. <i>MEASURING INSTRUMENT CALIBRATION .....</i>	<i>7</i>
4.2. <i>MEASUREMENT UNCERTAINTY.....</i>	<i>7</i>
<b>5. EQUIPMENT UNDER TEST .....</b>	<b>8</b>
5.1. <i>DESCRIPTION OF EUT .....</i>	<i>8</i>
5.2. <i>MAXIMUM OUTPUT POWER.....</i>	<i>9</i>
5.3. <i>CHANNEL LIST.....</i>	<i>9</i>
5.4. <i>TEST CHANNEL CONFIGURATION.....</i>	<i>10</i>
5.5. <i>THE WORSE CASE POWER SETTING PARAMETER.....</i>	<i>10</i>
5.6. <i>DESCRIPTION OF AVAILABLE ANTENNAS .....</i>	<i>11</i>
5.7. <i>TEST ENVIRONMENT .....</i>	<i>12</i>
5.8. <i>DESCRIPTION OF TEST SETUP.....</i>	<i>13</i>
5.9. <i>MEASURING INSTRUMENT AND SOFTWARE USED.....</i>	<i>14</i>
<b>6. MEASUREMENT METHODS .....</b>	<b>15</b>
<b>7. ANTENNA PORT TEST RESULTS.....</b>	<b>16</b>
7.1. <i>ON TIME AND DUTY CYCLE.....</i>	<i>16</i>
7.2. <i>6 dB BANDWIDTH AND 99% OCCUPIED BANDWIDTH .....</i>	<i>18</i>
7.3. <i>CONDUCTED OUTPUT POWER.....</i>	<i>26</i>
7.4. <i>POWER SPECTRAL DENSITY.....</i>	<i>31</i>
7.5. <i>CONDUCTED BANDEDGE AND SPURIOUS EMISSIONS.....</i>	<i>36</i>
7.6. <i>RADIATED TEST RESULTS .....</i>	<i>64</i>
7.6.1. <i>LIMITS AND PROCEDURE .....</i>	<i>64</i>
7.6.2. <i>TEST ENVIRONMENT .....</i>	<i>70</i>
7.6.3. <i>RESTRICTED BANDEDGE .....</i>	<i>70</i>
7.6.4. <i>SPURIOUS EMISSIONS .....</i>	<i>79</i>
<b>8. AC POWER LINE CONDUCTED EMISSIONS.....</b>	<b>111</b>
<b>9. ANTENNA REQUIREMENTS.....</b>	<b>114</b>



## 1. ATTESTATION OF TEST RESULTS

### Applicant Information

Company Name: Signify (China) Investment Co., Ltd  
Address: #204, Block 2, 690 Bibo Road, Zhang Jiang High-Tech Park,  
Shanghai, China

### Manufacturer Information

Company Name: Signify (China) Investment Co., Ltd  
Address: #204, Block 2, 690 Bibo Road, Zhang Jiang High-Tech Park,  
Shanghai, China

### EUT Description

Product Name: 2.4GHz Wi-Fi/ Bluetooth module  
Model Name: ESP32-C3-WIZ2012  
Sample Number: 3686975  
Data of Receipt Sample: Mar. 08, 2021  
Date Tested: Mar. 09, 2021~ May. 18, 2021

APPLICABLE STANDARDS	
STANDARD	TEST RESULTS
CFR 47 Part 15 Subpart C	PASS
ISED RSS-247 ISSUE 2	PASS



Summary of Test Results			
Clause	Test Items	FCC/IC Rules	Test Results
1	6dB Bandwidth and 99% Occupied Bandwidth	FCC Part 15.247 (a) (2) RSS-247 Clause 5.2 (a) ISED RSS-Gen Clause 6.7	Complied
2	Peak Conducted Output Power	FCC Part 15.247 (b) (3) RSS-247 Clause 5.4 (d)	Complied
3	Power Spectral Density	FCC Part 15.247 (e) RSS-247 Clause 5.2 (b)	Complied
4	Conducted Bandedge and Spurious Emission	FCC Part 15.247 (d) RSS-247 Clause 5.5	Complied
5	Radiated Bandedge and Spurious Emission	FCC Part 15.247 (d) FCC Part 15.209 FCC Part 15.205 RSS-247 Clause 5.5 RSS-GEN Clause 8.9	Complied
6	Conducted Emission Test For AC Power Port	FCC Part 15.207 RSS-GEN Clause 8.8	Complied
7	Antenna Requirement	FCC Part 15.203 RSS-GEN Clause 6.8	Complied
Remark: 1) The measurement result for the sample received is <Pass> according to < ANSI C63.10-2013, FCC CFR 47 Part 2, FCC CFR 47 Part 15C and ISED RSS-247 ISSUE 2> when <Accuracy Method>			

Prepared By:

*Jason Yang*

Jason Yang  
Engineer

Reviewed By:

*Tom Tang*

Tom Tang  
Project Engineer

Authorized By:

*Chris Zhong*

Chris Zhong  
Laboratory Leader



## 2. TEST METHODOLOGY

The tests documented in this report were performed in accordance with KDB 558074 D01 15.247 Meas Guidance v05r02, KDB 414788 D01 Radiated Test Site v01r01, CFR 47 FCC Part 2, CFR 47 FCC Part 15, ANSI C63.10-2013, ISED RSS-247 Issue 2 and ISED RSS-GEN Issue 5.

## 3. FACILITIES AND ACCREDITATION

Accreditation Certificate	<p><b>A2LA (Certificate No.: 4829.01)</b>  <b>UL-CCIC COMPANY LIMITED has been assessed and proved to be in compliance with A2LA.</b></p> <p><b>FCC (FCC Designation No.: CN1247)</b>  <b>UL-CCIC COMPANY LIMITED has been recognized to perform compliance testing on equipment subject to the Commission's Declaration of Conformity (DoC) and Certification rules.</b></p> <p><b>IC (IC Designation No.: 25056)</b>  <b>UL-CCIC COMPANY LIMITED has been recognized to perform compliance testing on equipment subject to the Commission's Declaration of Conformity (DoC) and Certification rules.</b></p>
---------------------------	--

Note 1: All tests measurement facilities use to collect the measurement data are located at No. 2, Chengwan Road, Suzhou Industrial Park, Suzhou 215122, People's Republic of China

Note 2: For below 30MHz, lab had performed measurements at test anechoic chamber and comparing to measurements obtained on an open field site. These measurements below 30MHz had been correlated to measurements performed on an OFS.

Note 3: The test anechoic chamber in UL-CCIC COMPANY LIMITED had been calibrated and compared to the open field sites and the test anechoic chamber is shown to be equivalent to or worst case from the open field site.



## 4. CALIBRATION AND UNCERTAINTY

### 4.1. MEASURING INSTRUMENT CALIBRATION

The measuring equipment utilized to perform the tests documented in this report has been calibrated in accordance with the manufacturer's recommendations, and is traceable to recognized national standards.

### 4.2. MEASUREMENT UNCERTAINTY

Where relevant, the following measurement uncertainty levels have been estimated for tests performed on the apparatus:

Test Item	Uncertainty
Conduction emission	3.1dB
Radiation Emission test(include Fundamental emission) (9KHz-30MHz)	3.4dB
Radiation Emission test(include Fundamental emission) (30MHz-1GHz)	3.4dB
Radiation Emission test (1GHz to 26GHz)( include Fundamental emission)	3.9dB (1GHz-18Gz)
	4.2dB (18GHz-26.5Gz)
Note: This uncertainty represents an expanded uncertainty expressed at approximately the 95% confidence level using a coverage factor of k=2.	



## 5. EQUIPMENT UNDER TEST

### 5.1. DESCRIPTION OF EUT

Product Name:	2.4GHz Wi-Fi/ Bluetooth module
Model No.:	ESP32-C3-WIZ2012
Operating Frequency:	IEEE 802.11b/g/n(HT20): 2412MHz to 2462MHz IEEE 802.11n(HT40): 2422MHz to 2452MHz BT:2402 MHz to 2480MHz
	This report just for the BT part
Type of Modulation:	IEEE for 802.11b: DSSS (CCK, DQPSK, DBPSK) IEEE for 802.11g: OFDM (64QAM, 16QAM, QPSK, BPSK) IEEE for 802.11n (HT20 and HT40): OFDM (64QAM, 16QAM, QPSK, BPSK) BT:GFSK
Test software of EUT:	EspRFTestTool (manufacturer declare)
Antenna Type:	Ceramic antenna
Antenna Gain:	Antenna1: 5.19 dBi
	Remark: This data is provided by customer and our lab isn't responsible for this data



### 5.2. MAXIMUM OUTPUT POWER

Bluetooth Mode	Frequency (MHz)	Channel Number	Max Output Power (dBm)
BLE	2402-2480	0-39[40]	3.98

### 5.3. CHANNEL LIST

Channel	Frequency (MHz)	Channel	Frequency (MHz)	Channel	Frequency (MHz)	Channel	Frequency (MHz)
0	2402	11	2424	22	2446	33	2468
1	2404	12	2426	23	2448	34	2470
2	2406	13	2428	24	2450	35	2472
3	2408	14	2430	25	2452	36	2474
4	2410	15	2432	26	2454	37	2476
5	2412	16	2434	27	2456	38	2478
6	2414	17	2436	28	2458	39	2480
7	2416	18	2438	29	2460		
8	2418	19	2440	30	2462		
9	2420	20	2442	31	2464		
10	2422	21	2444	32	2468		



#### 5.4. TEST CHANNEL CONFIGURATION

Test Mode	Test Channel	Frequency
BLE-1M	CH 0, CH 19, CH 39	2402MHz, 2440MHz, 2480MHz
BLE-2M	CH 0, CH 19, CH 39	2402MHz, 2440MHz, 2480MHz

#### 5.5. THE WORSE CASE POWER SETTING PARAMETER

The Worst Case Power Setting Parameter under 2400 ~ 2483.5MHz Band				
Test Software		EspRFTTestTool		
Test Mode	Transmit Antenna Number	Test Channel		
		CH 00	CH 19	CH 39
BLE-1M	1	9	9	9
BLE-2M	1	9	9	9



### 5.6. DESCRIPTION OF AVAILABLE ANTENNAS

Ant.	Frequency (MHz)	Antenna Type	Antenna Gain (dBi)
1	2402-2480	Ceramic antenna	5.19

Test Modulation	Transmit and Receive Mode	Description
GFSK	<input checked="" type="checkbox"/> 1TX, 1RX	Antenna 1 can be used as transmitting/receiving antenna.



### 5.7. TEST ENVIRONMENT

Environment Parameter	Selected Values During Tests	
Relative Humidity	55 ~ 65%	
Atmospheric Pressure:	1025Pa	
Temperature	TN	23 ~ 28°C
Voltage:	VL	N/A
	VN	AC 120V
	VH	N/A

Note: VL= Lower Extreme Test Voltage  
VN= Nominal Voltage  
VH= Upper Extreme Test Voltage  
TN= Normal Temperature

## 5.8. DESCRIPTION OF TEST SETUP

### SUPPORT EQUIPMENT

Item	Equipment	Brand Name	Model Name	Description
1	Laptop	ThinkPad	E550c	N/A
2	Fixed Frequency Board	N/A	N/A	Supply by Customer
3	AC adapter	AC/DA ADAPTER	N/A	INPUT:100-240V~50/60Hz OUTPUT:5V  1A (Supply by UL Lab)

### I/O PORT

Cable No	Port	Connector Type	Cable Type	Cable Length(m)	Remarks
1	N/A	N/A	N/A	N/A	N/A

### ACCESSORY

Item	Accessory	Brand Name	Model Name	Description
1	USB Cable	NA	NA	100cm Length (Supply by UL Lab)

### TEST SETUP

The EUT can work in an engineer mode with a software through a table PC.

### SETUP DIAGRAM FOR TESTS

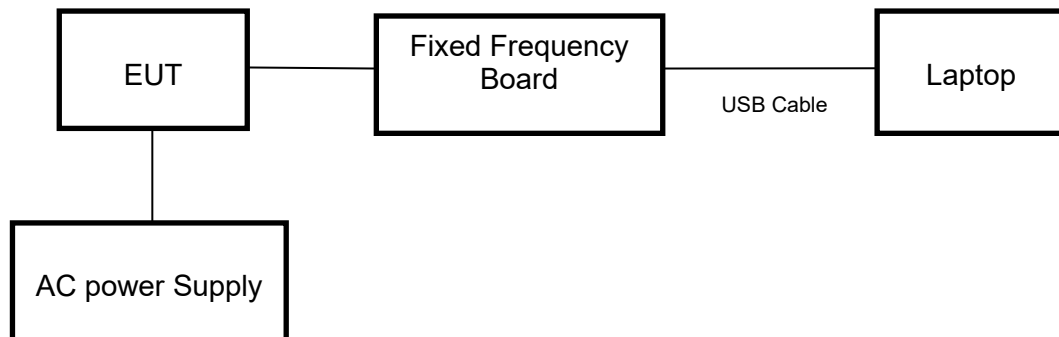



### 5.9. MEASURING INSTRUMENT AND SOFTWARE USED

Conducted Emissions (Instrument)							
Used	Equipment	Manufacturer	Model No.	Serial No.	Upper Last Cal.	Last Cal.	Next Cal.
<input checked="" type="checkbox"/>	EMI Test Receiver	R&S	ESR3	126700	2019-12-12	2020-12-05	2021-12-04
<input checked="" type="checkbox"/>	Two-Line V-Network	R&S	ENV216	126701	2019-12-12	2020-12-05	2021-12-04
<input checked="" type="checkbox"/>	Artificial Mains Networks	R&S	ENY81	126711	2019-12-12	2020-12-05	2021-12-04
Software							
Used	Description		Manufacturer	Name	Version		
<input checked="" type="checkbox"/>	Test Software for Conducted disturbance		R&S	EMC32	Ver. 9.25		
Radiated Emissions (Instrument)							
Used	Equipment	Manufacturer	Model No.	Serial No.	Upper Last Cal.	Last Cal.	Next Cal.
<input checked="" type="checkbox"/>	Spectrum Analyzer	Keysight	N9010B	MY57110128	2020-05-10	2021-05-09	2022-05-08
<input checked="" type="checkbox"/>	EMI test receiver	R&S	ESR26	1267603	2019-12-12	2020-12-05	2021-12-04
<input checked="" type="checkbox"/>	Receiver Antenna (9kHz-30MHz)	Schwarzbeck	FMZB 1513	513-265	N/A	2018-06-15	2021-06-14
<input checked="" type="checkbox"/>	Receiver Antenna (30MHz-1GHz)	SunAR RF Motion	JB1	177821	N/A	2019-01-28	2022-01-27
<input checked="" type="checkbox"/>	Receiver Antenna (1GHz-18GHz)	R&S	HF907	126705	2018-01-29	2019-01-28	2022-01-27
<input checked="" type="checkbox"/>	Receiver Antenna (18GHz-26.5GHz)	Schwarzbeck	BBHA9170	126706	2019-02-06	2020-12-05	2021-12-04
<input checked="" type="checkbox"/>	Pre-amplification (To 18GHz)	Compliance Direction System Inc.	PAP-1G18-50	14140-13467	2019-03-18	2020-12-05	2021-12-04
<input checked="" type="checkbox"/>	Pre-amplification (To 26.5GHz)	R&S	SCU-26D	134668	2019-02-06	2020-09-27	2021-09-26
<input checked="" type="checkbox"/>	Band Reject Filter	Wainwright	WRCJV8-2350-2400-2483.5-2533.5-40SS	1	2020-05-10	2021-05-09	2022-05-08
<input checked="" type="checkbox"/>	Highpass Filter	Wainwright	WHKX10-2700-3000-18000-40SS	2	2020-05-10	2021-05-09	2022-05-08
Software							
Used	Description		Manufacturer	Name	Version		
<input checked="" type="checkbox"/>	Test Software for Radiated disturbance		Tonscend	JS32	V1.0		
Other instruments							
Used	Equipment	Manufacturer	Model No.	Serial No.	Upper Last Cal.	Last Cal.	Next Cal.
<input checked="" type="checkbox"/>	Spectrum Analyzer	Keysight	N9010B	MY57110128	2020-05-10	2021-05-09	2022-05-08
<input checked="" type="checkbox"/>	Power Meter	Keysight	U2021XA	MY57110002	2020-05-10	2021-05-09	2022-05-08



## 6. MEASUREMENT METHODS

No.	Test Item	KDB Name	Section
1	6dB Bandwidth/99% Bandwidth	KDB 558074 D01 15.247 Meas Guidance v05r02	8.2
2	Peak Output Power	KDB 558074 D01 15.247 Meas Guidance v05r02	8.3.1.3/8.3.2.3
3	Power Spectral Density	KDB 558074 D01 15.247 Meas Guidance v05r02	8.4
4	Out-of-band emissions in non-restricted bands	KDB 558074 D01 15.247 Meas Guidance v05r02	8.5
5	Out-of-band emissions in restricted bands	KDB 558074 D01 15.247 Meas Guidance v05r02	8.6
6	Band-edge	KDB 558074 D01 15.247 Meas Guidance v05r02	8.7
7	Conducted Emission Test For AC Power Port	ANSI C63.10-2013	6.2



## 7. ANTENNA PORT TEST RESULTS

### 7.1. ON TIME AND DUTY CYCLE

#### LIMITS

None; for reporting purposes only

#### PROCEDURE

FCC KDB 558074 Zero-Span Spectrum Analyzer Method

#### TEST SETUP

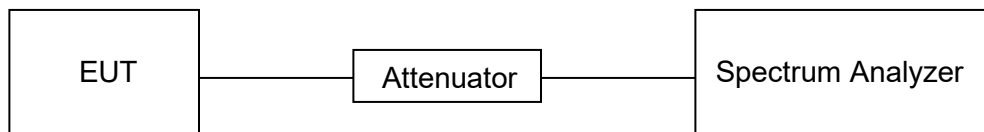

#### TEST ENVIRONMENT

Temperature	22°C	Relative Humidity	56%
Atmosphere Pressure	101kPa	Test Voltage	AC120V

#### RESULTS

Mode	On Time (msec)	Period (msec)	Duty Cycle x (Linear)	Duty Cycle (%)	Duty Cycle Correction Factor (db)	1/T Minimum VBW (KHz)	Final Setting VBW (KHz)
BLE -1M	2.093	2.5005	0.837	83.7	0.77	0.48	1
BLE -2M	1.056	1.8775	0.562	56.2	2.50	0.95	1

Note: 1) Duty Cycle Correction Factor=10log(1/x).  
 2) Where: x is Duty Cycle (Linear)  
 3) Where: T is On Time (transmit duration)

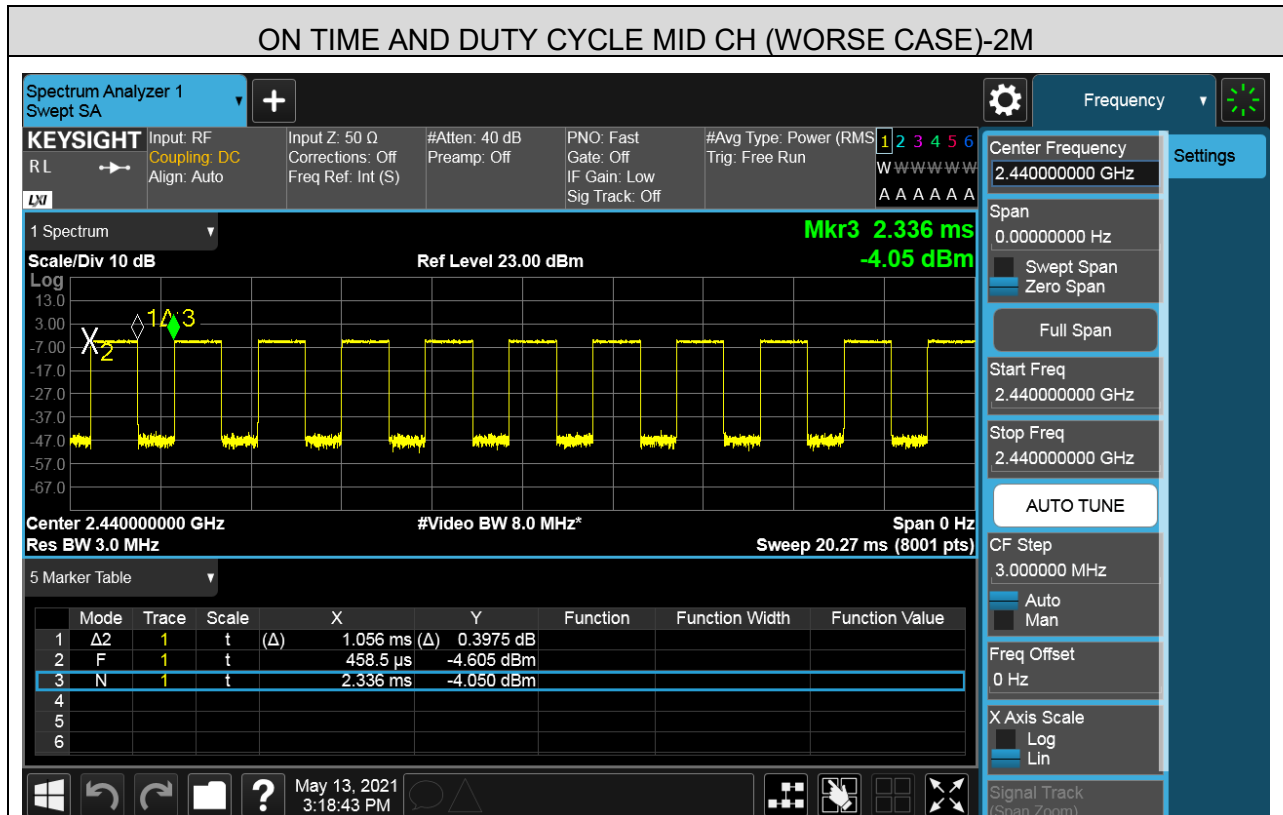
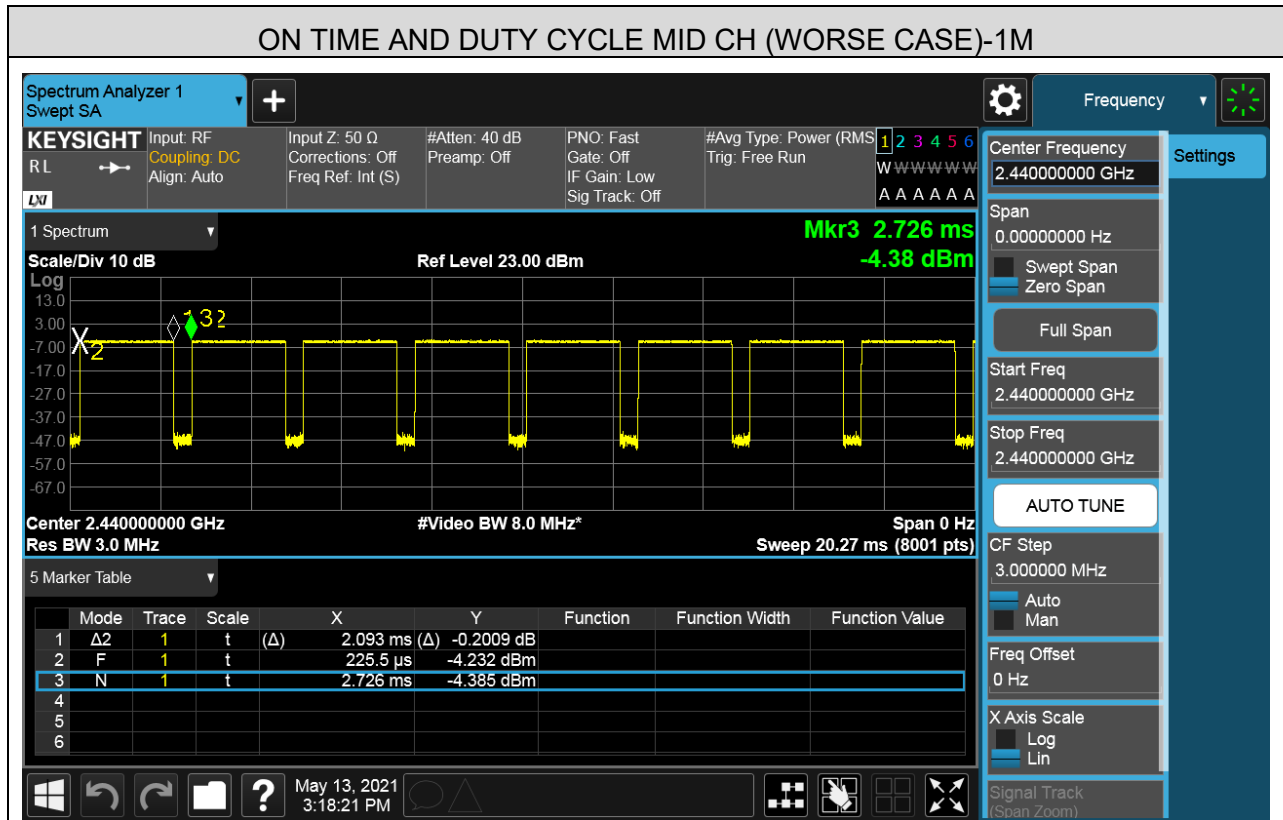

## 7.2. 6 dB BANDWIDTH AND 99% OCCUPIED BANDWIDTH

### LIMITS

FCC Part15 (15.247) Subpart C, ISED RSS-247 ISSUE 2			
Section	Test Item	Limit	Frequency Range (MHz)
CFR 47 FCC 15.247(a)(2) ISED RSS-247 5.2 (a)	6 dB Bandwidth	≥ 500KHz	2400-2483.5
ISED RSS-Gen Clause 6.7	99% Occupied Bandwidth	For reporting purposes only	2400-2483.5

### TEST PROCEDURE

Refer to FCC KDB 558074, connect the UUT to the spectrum analyzer and use the following settings:

Center Frequency	The centre frequency of the channel under test
Detector	Peak
RBW	For 6dB Bandwidth :100kHz For 99% Occupied Bandwidth :1% to 5% of the occupied bandwidth
VBW	For 6dB Bandwidth : ≥3 × RBW For 99% Occupied Bandwidth : ≥3×RBW
Trace	Max hold
Sweep	Auto couple

Allow the trace to stabilize and measure the maximum width of the emission that is constrained by the frequencies associated with the two outermost amplitude points (upper and lower frequencies) that are attenuated by 6 dB relative to the maximum level measured in the fundamental emission.

### TEST SETUP

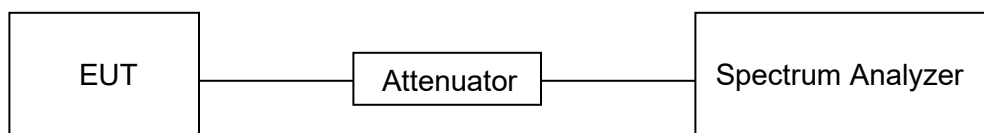



**RESULTS**

Test Mode	Test Channel	6dB bandwidth (MHz)	99% bandwidth (MHz)	Result
BLE-1M	LCH	0.6366	1.0297	Pass
	MCH	0.6505	1.0250	Pass
	HCH	0.6397	1.0283	Pass
BLE-2M	LCH	1.100	2.0341	Pass
	MCH	1.100	2.0363	Pass
	HCH	1.093	2.0368	Pass



**Test Graphs**  
**For 6dB Bandwidth part 1M:**

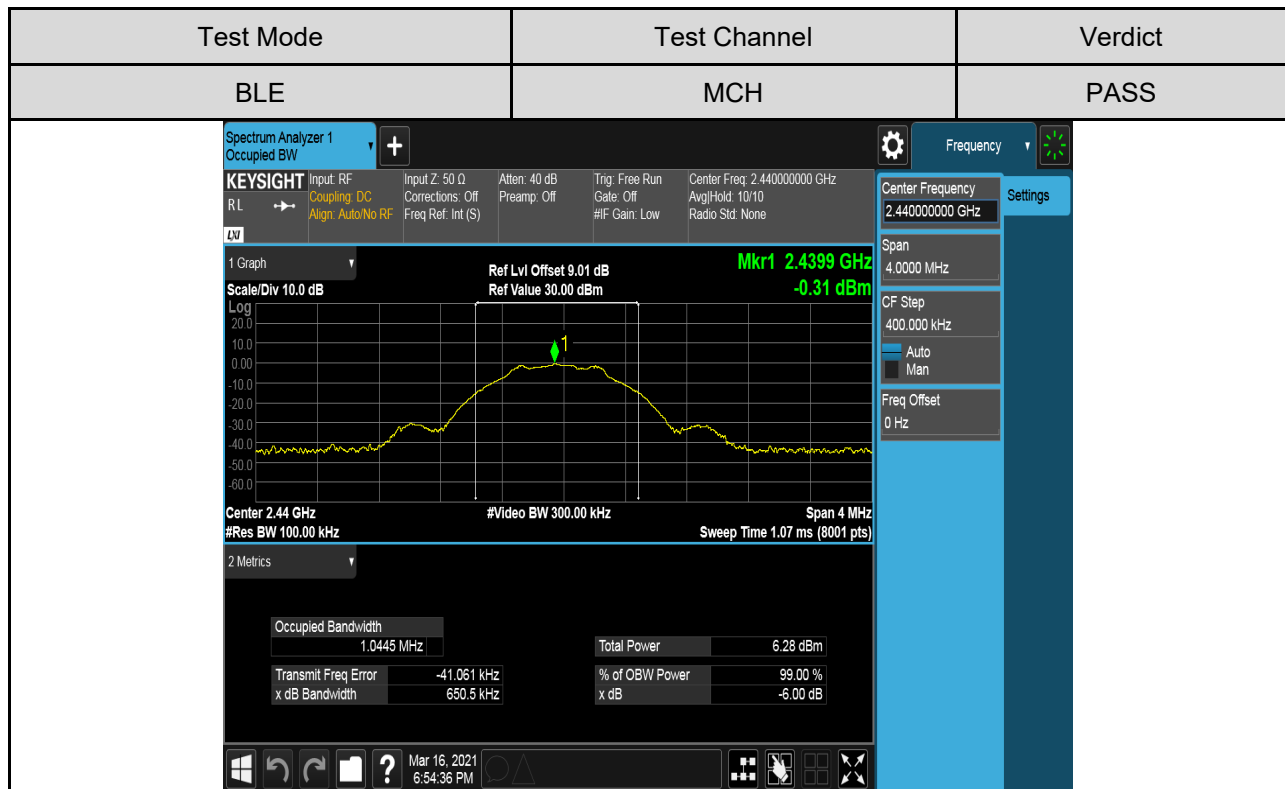
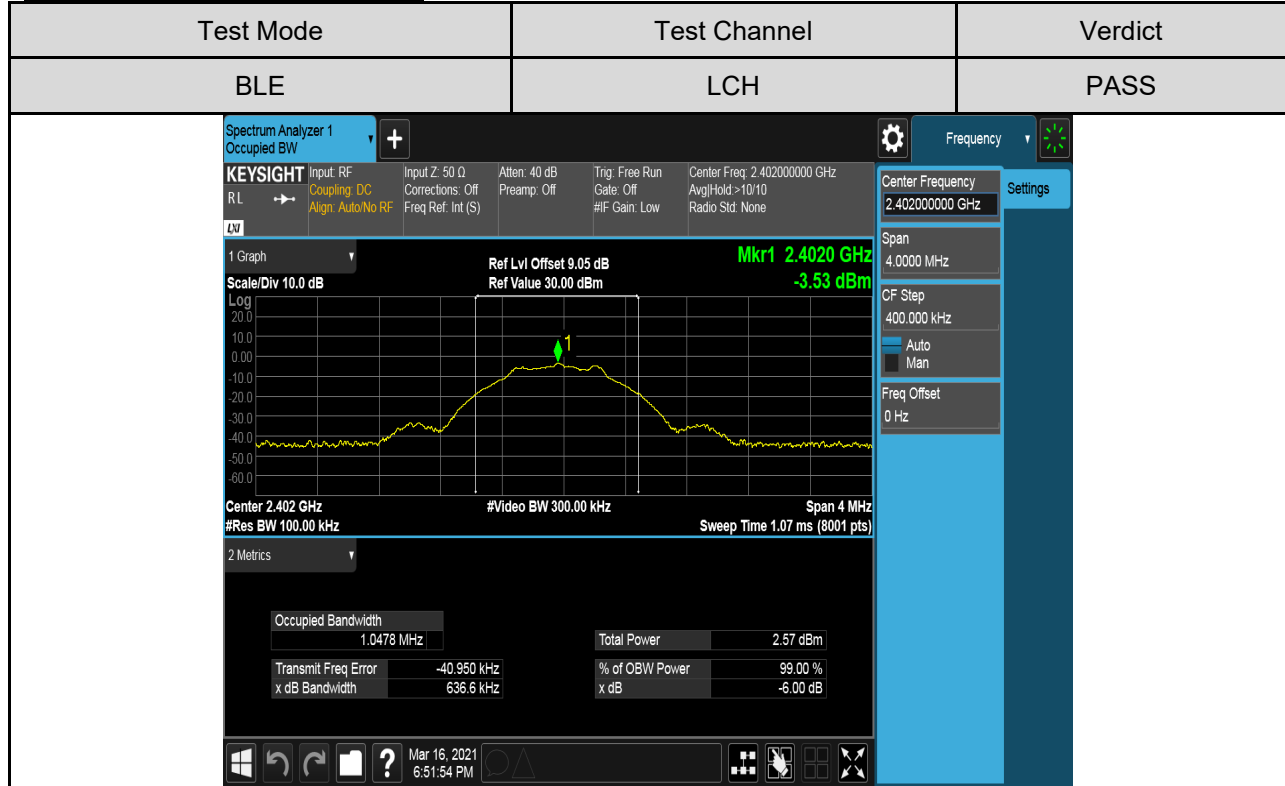

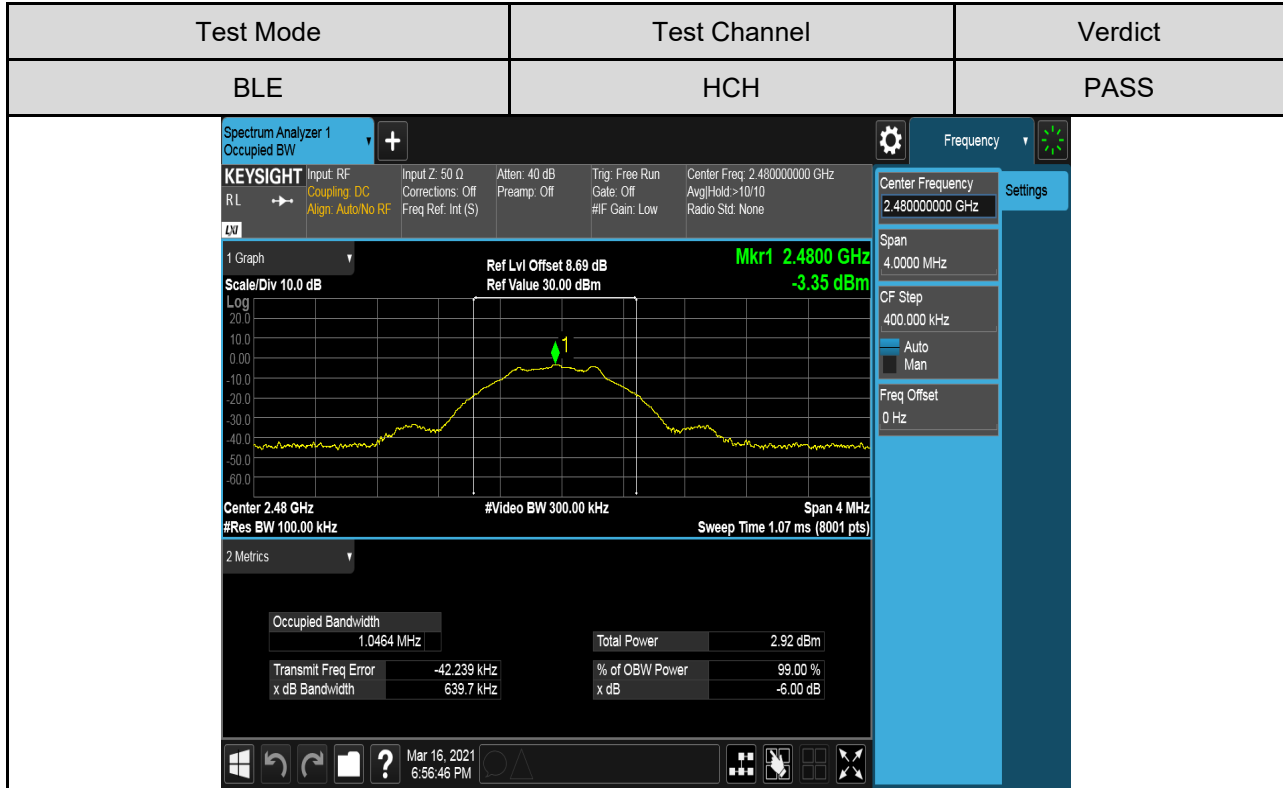

**For 6dB Bandwidth part 2M:**

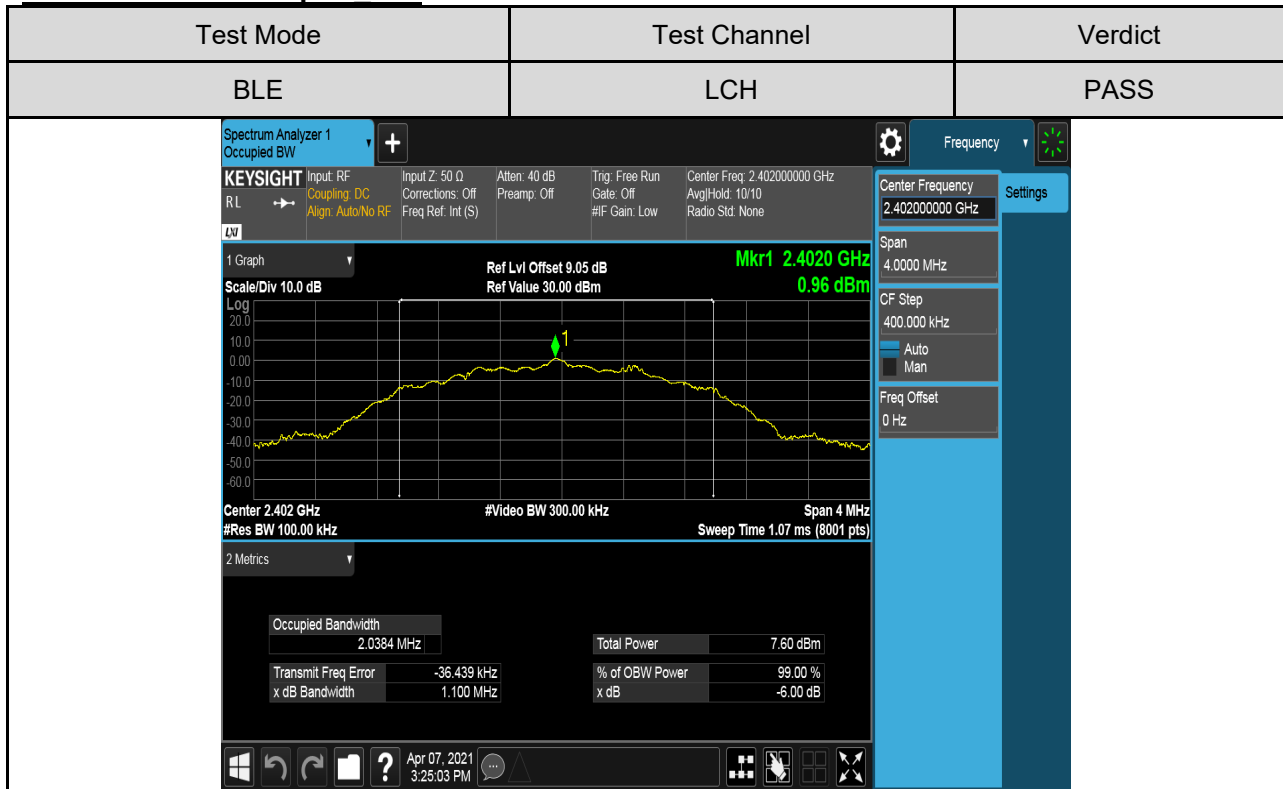

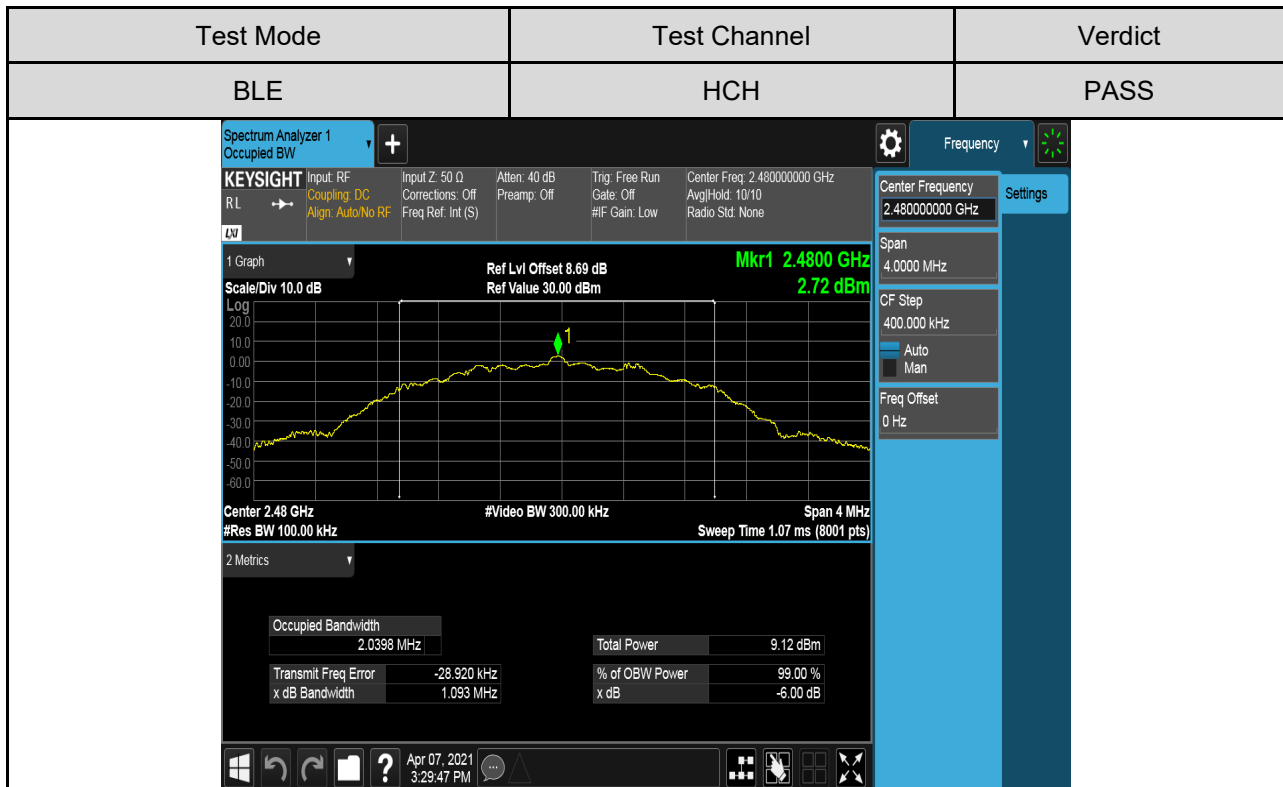
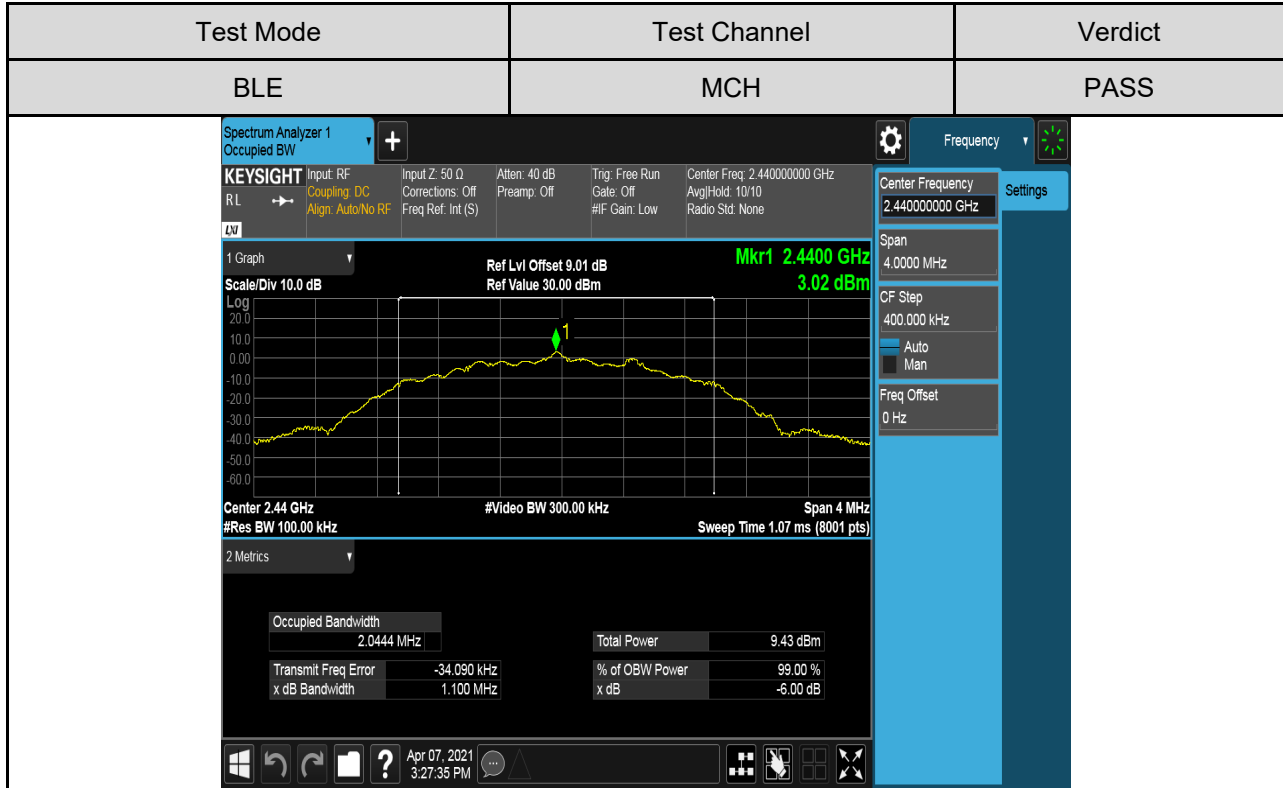



**For 99% Bandwidth part 1M:**

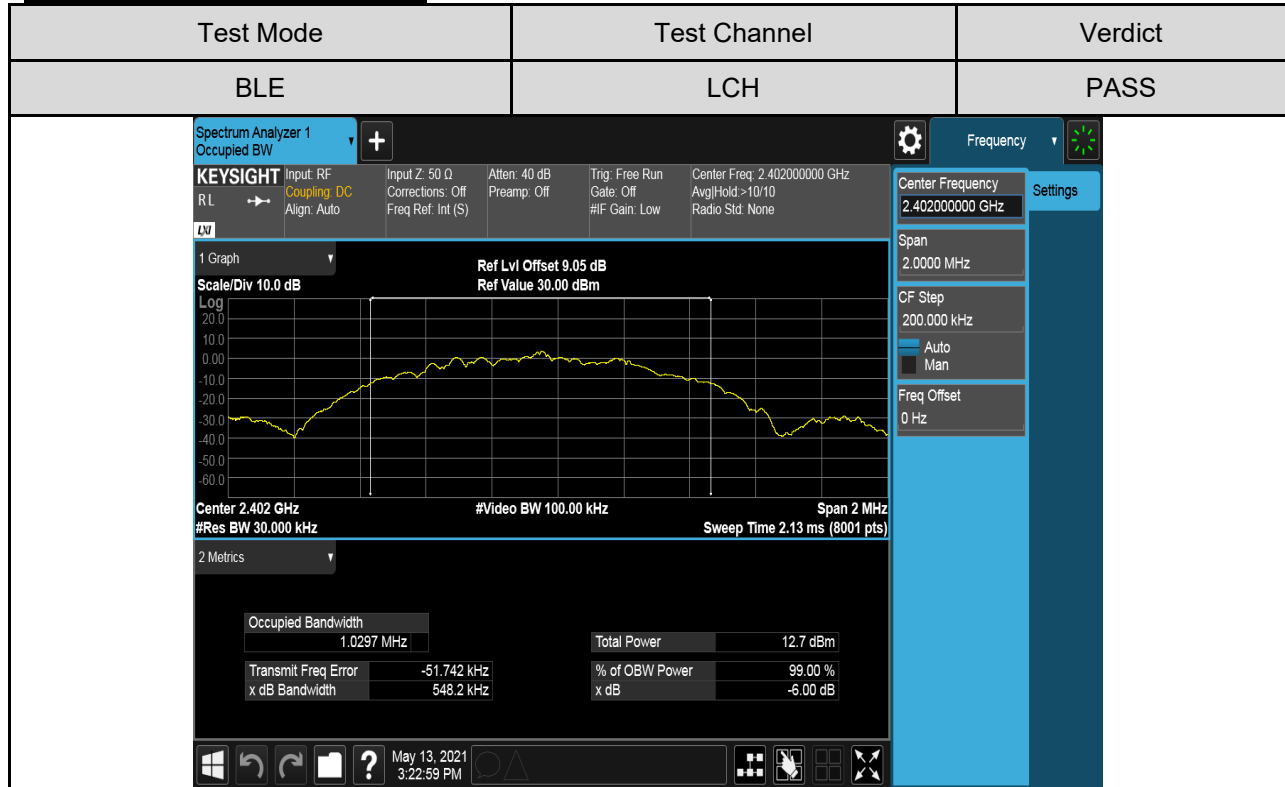

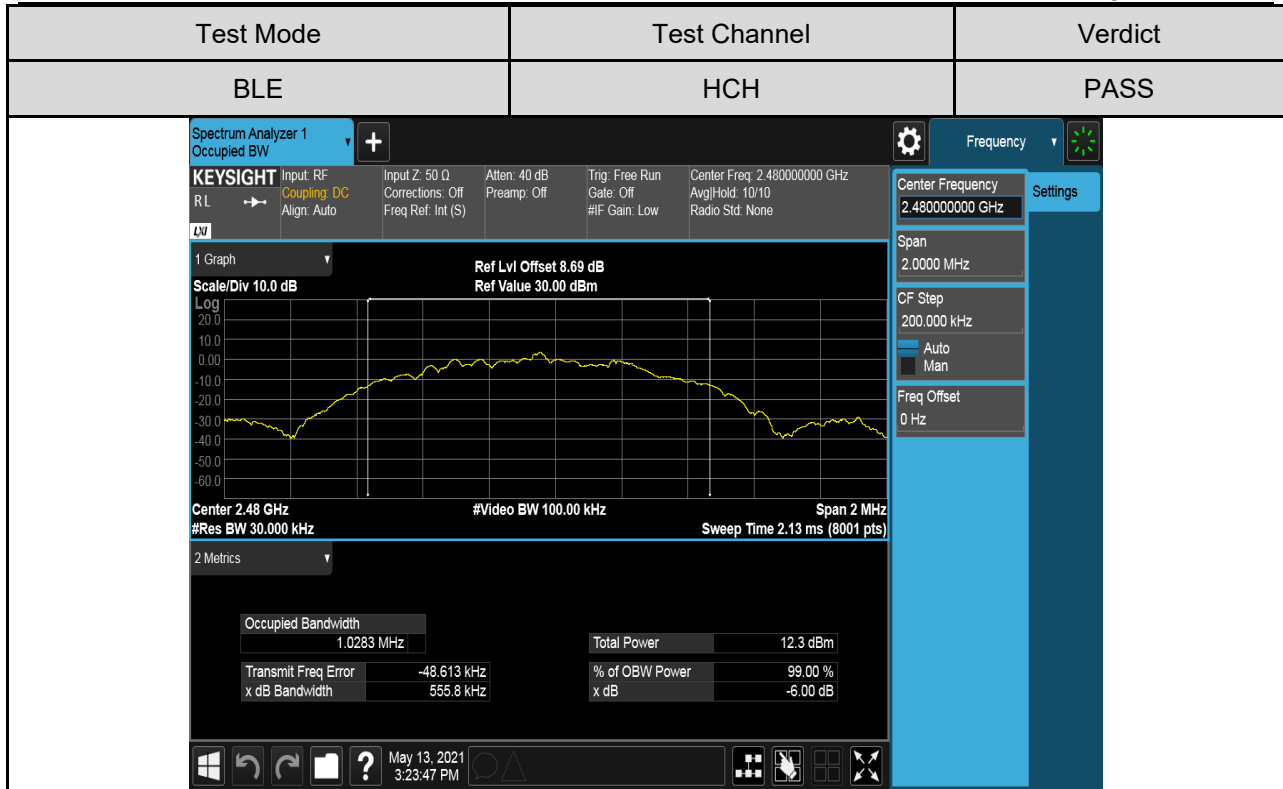

**For 99% Bandwidth part 2M:**

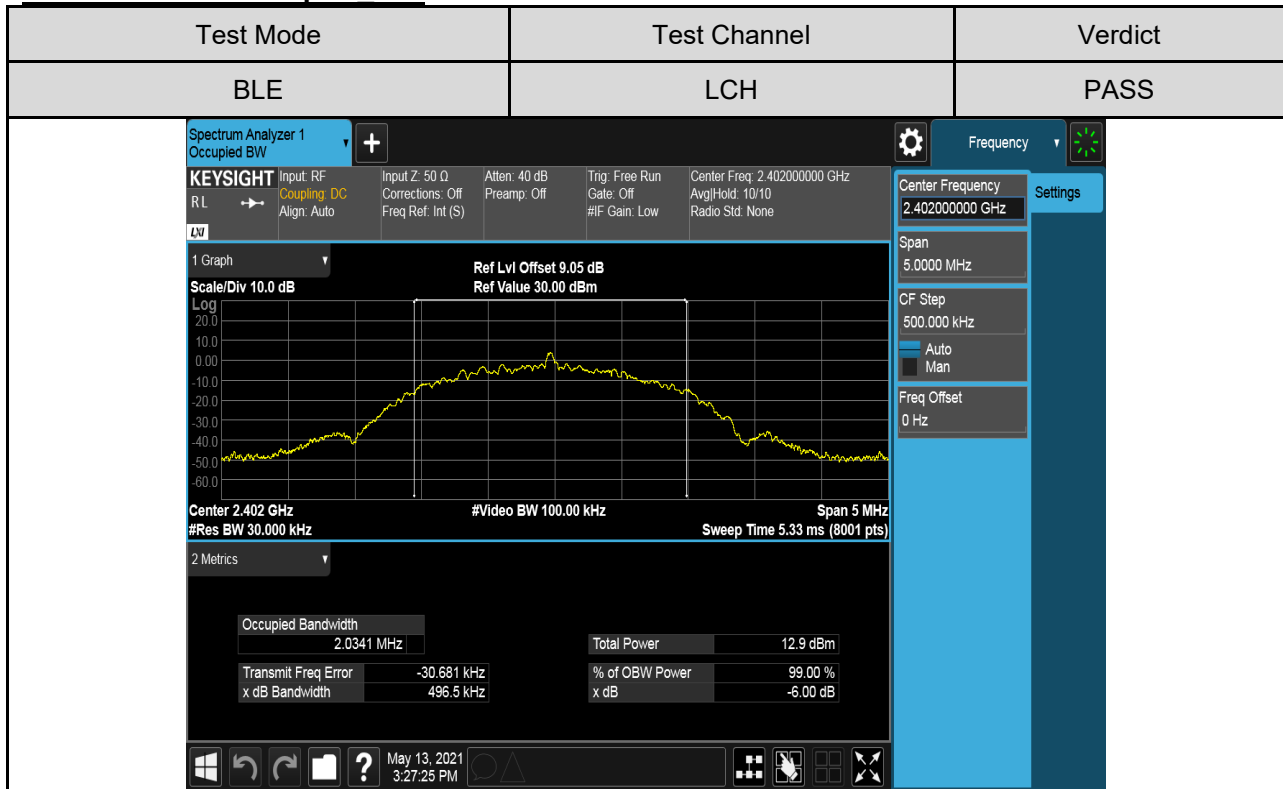

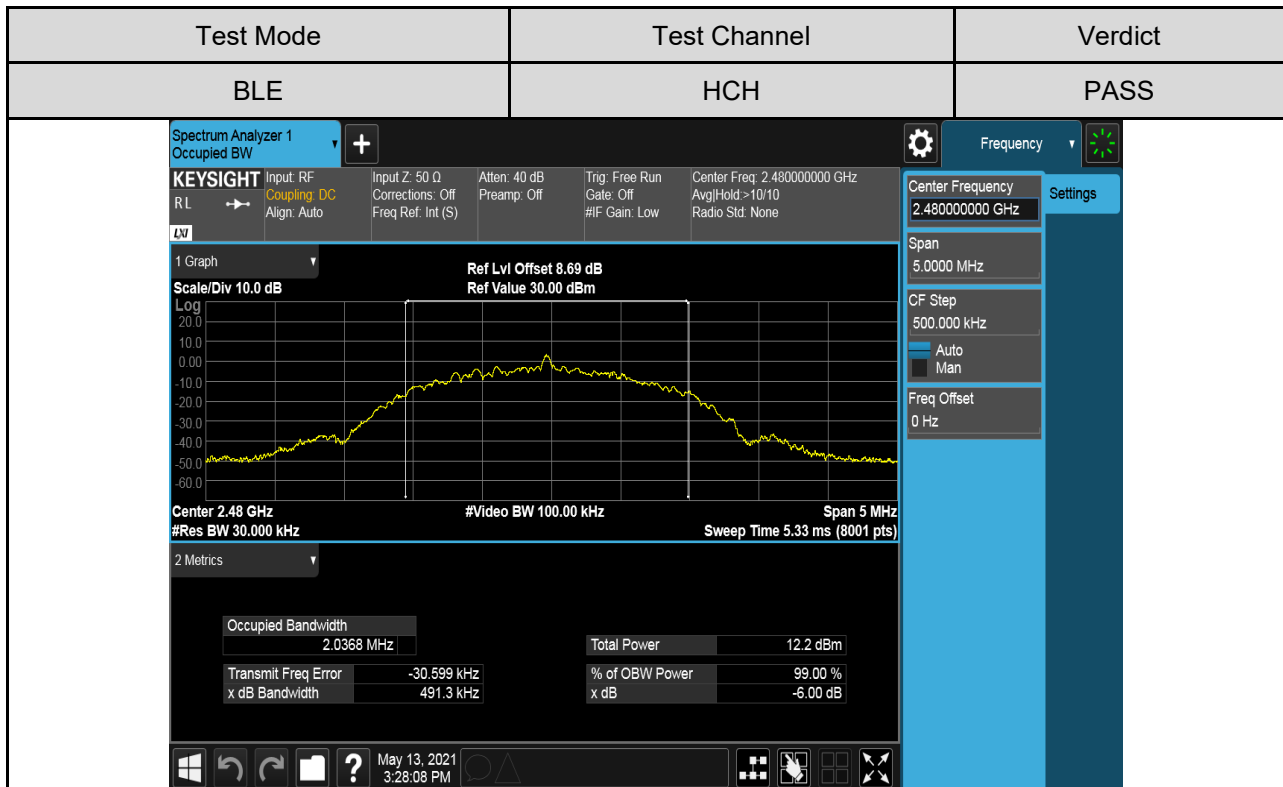
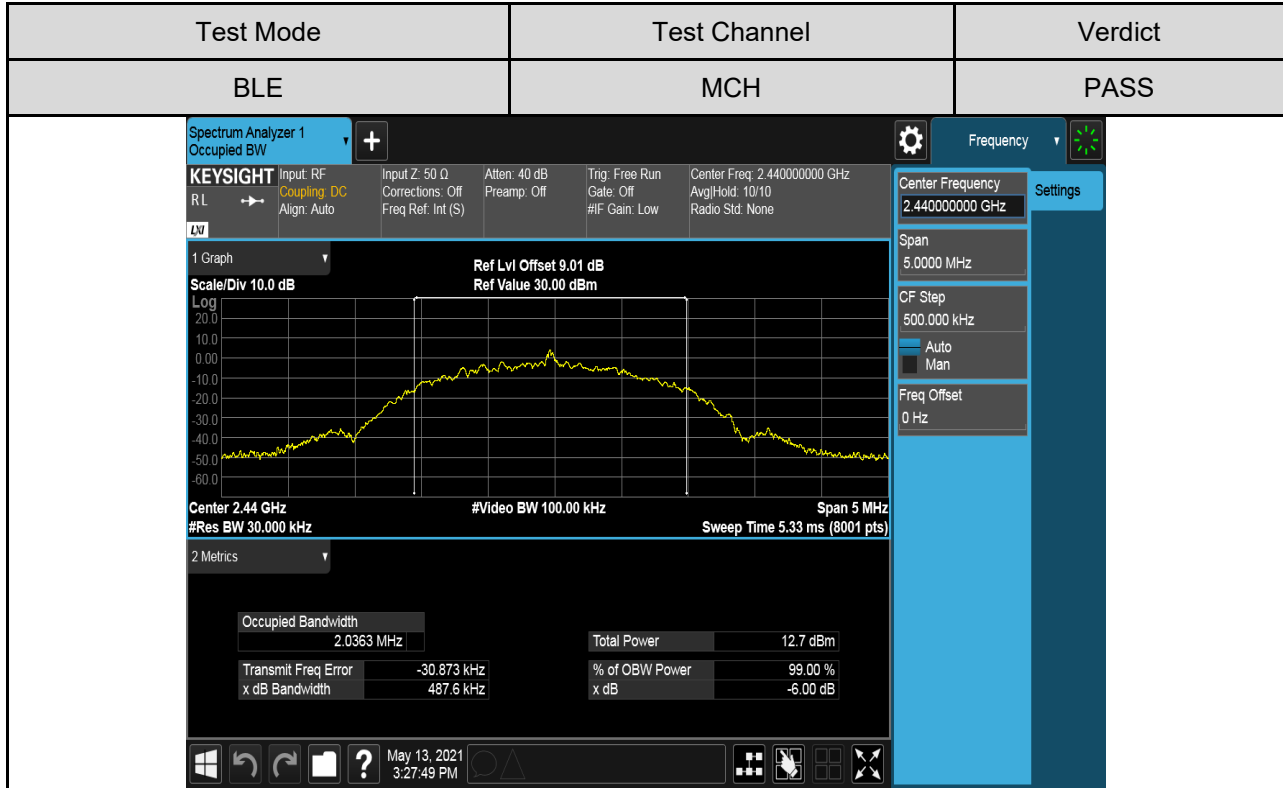



### 7.3. CONDUCTED OUTPUT POWER

#### LIMITS

FCC Part15 (15.247) Subpart C, ISED RSS-247 ISSUE 2			
Section	Test Item	Limit	Frequency Range (MHz)
CFR 47 FCC 15.247(b)(3) ISED RSS-247 5.4 (d)	Output Power	1 watt or 30dBm	2400-2483.5

Note: For b/g/n HT20 mode the average data is for reference only.

#### TEST PROCEDURE

Place the EUT on the table and set it in the transmitting mode.  
Remove the antenna from the EUT and then connect a low loss RF cable from the antenna port to the Power sensor.  
Measure the power of each channel.  
Peak Detector used for Peak result.

#### TEST ENVIRONMENT

Temperature	22°C	Relative Humidity	56%
Atmosphere Pressure	101kPa	Test Voltage	AC120V

#### TEST SETUP

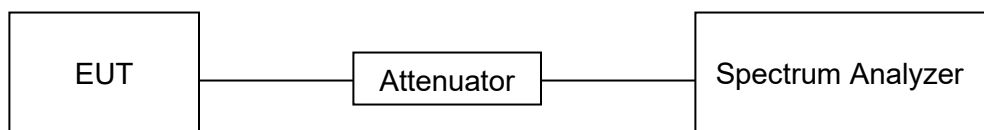



**RESULTS**

Test Mode	Test Channel	Maximum Peak Conducted Output Power(dBm)	LIMIT
			dBm
BLE-1M	LCH	2.26	30
	MCH	3.36	30
	HCH	3.69	30
BLE-2M	LCH	2.35	30
	MCH	3.56	30
	HCH	3.98	30



**Test Graphs  
FOR 1M part**

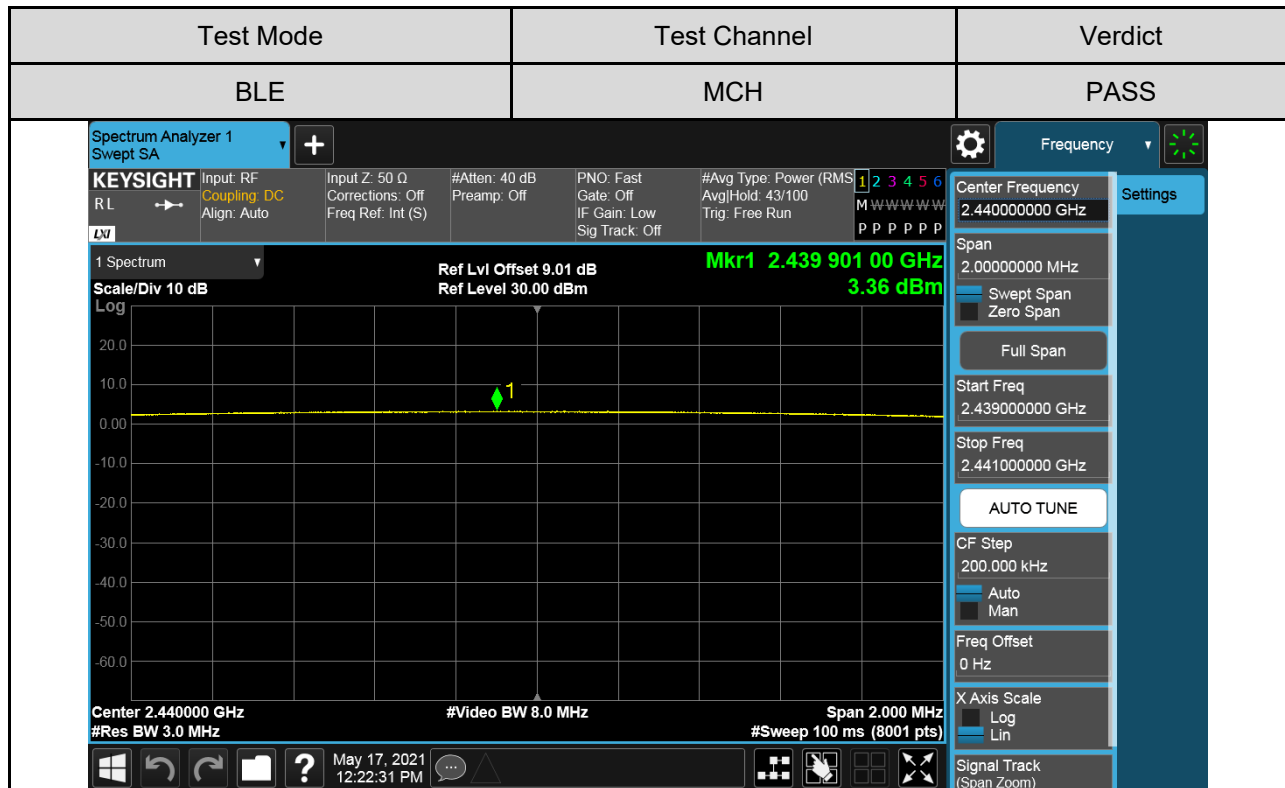
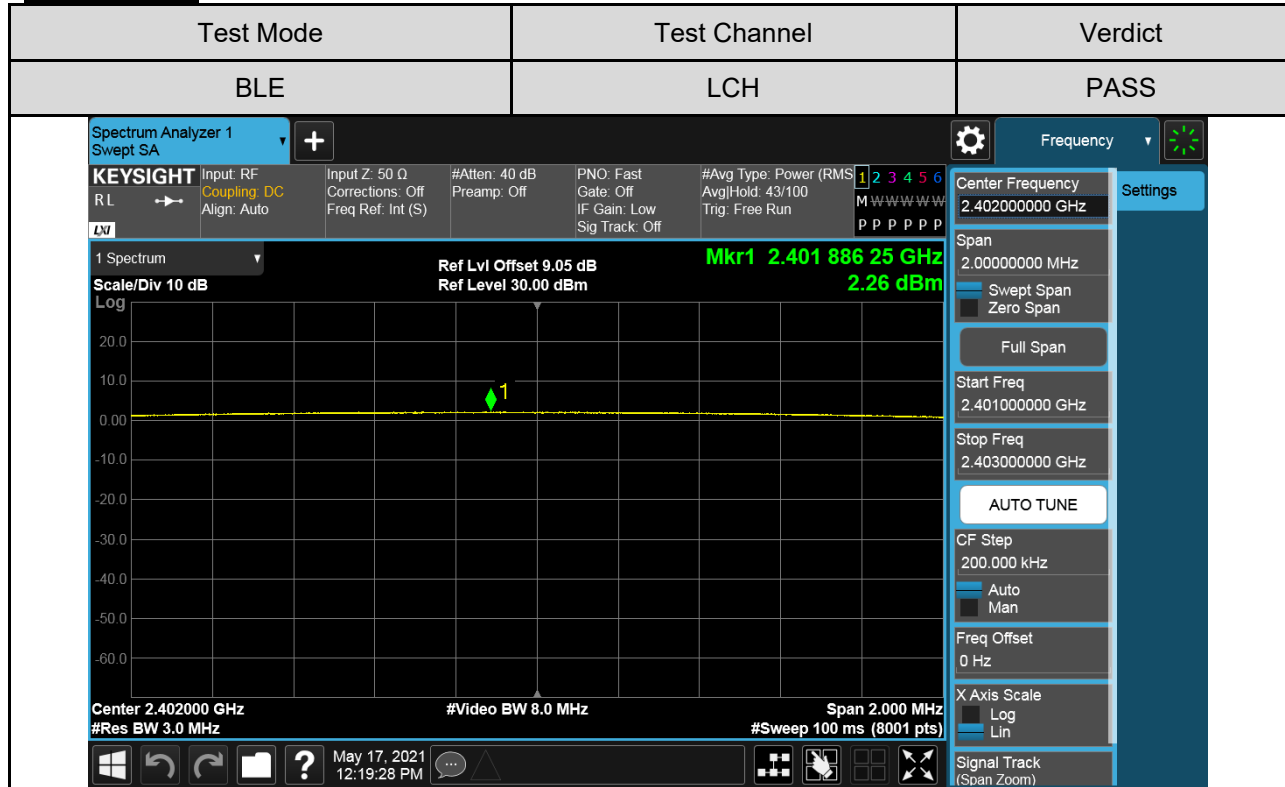

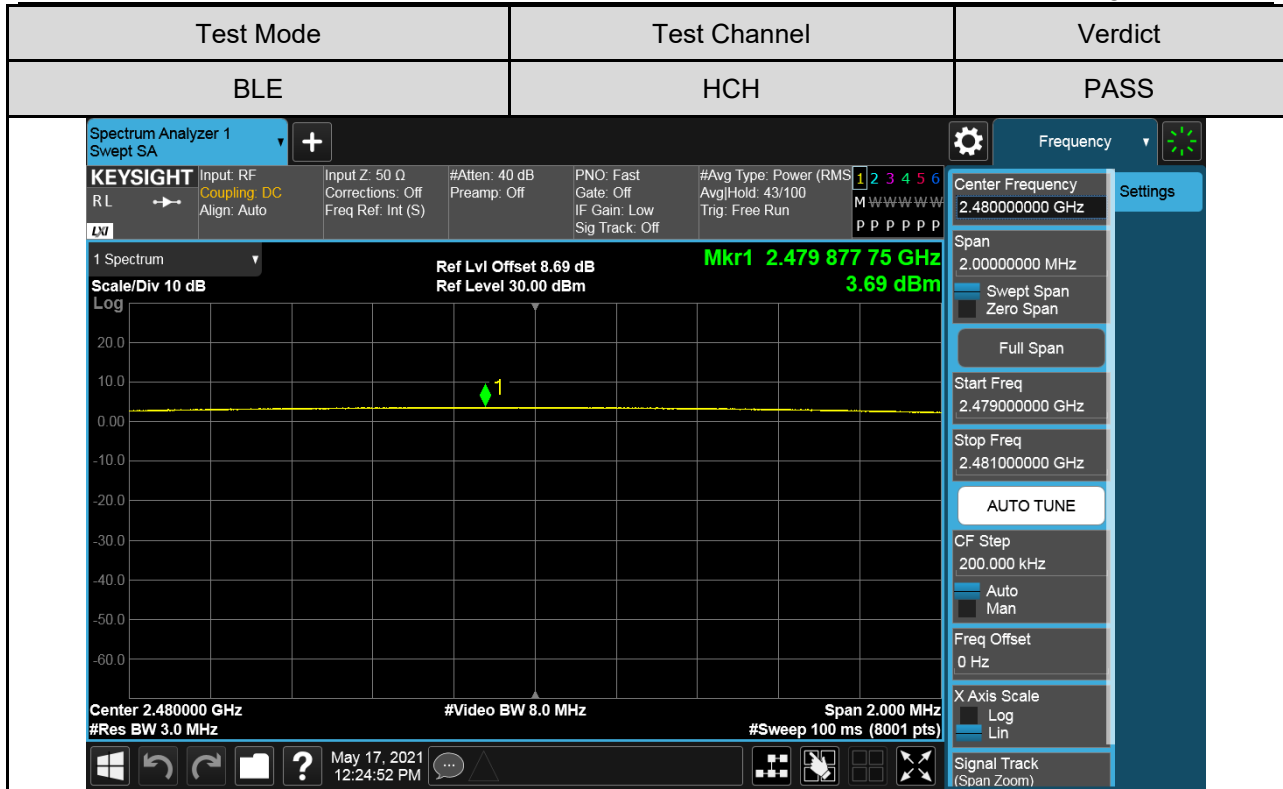

**FOR 2M part**

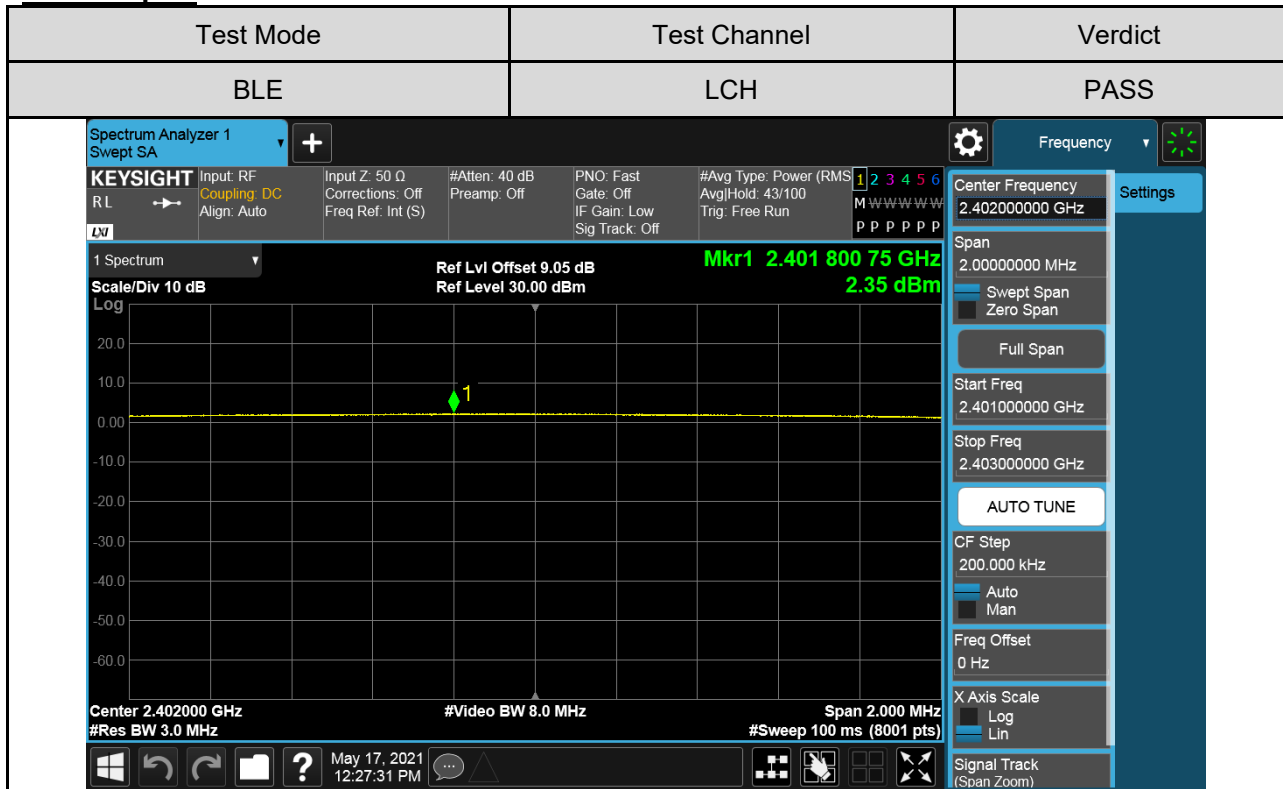

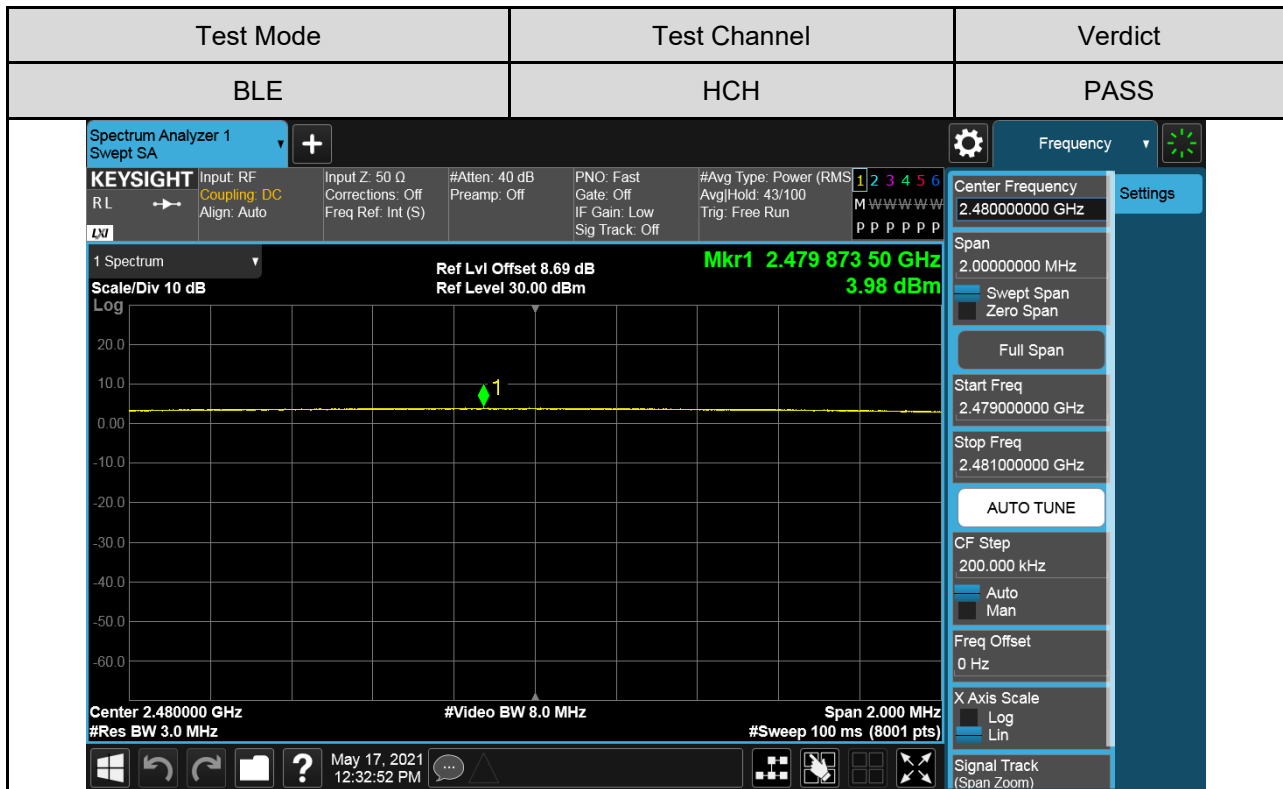
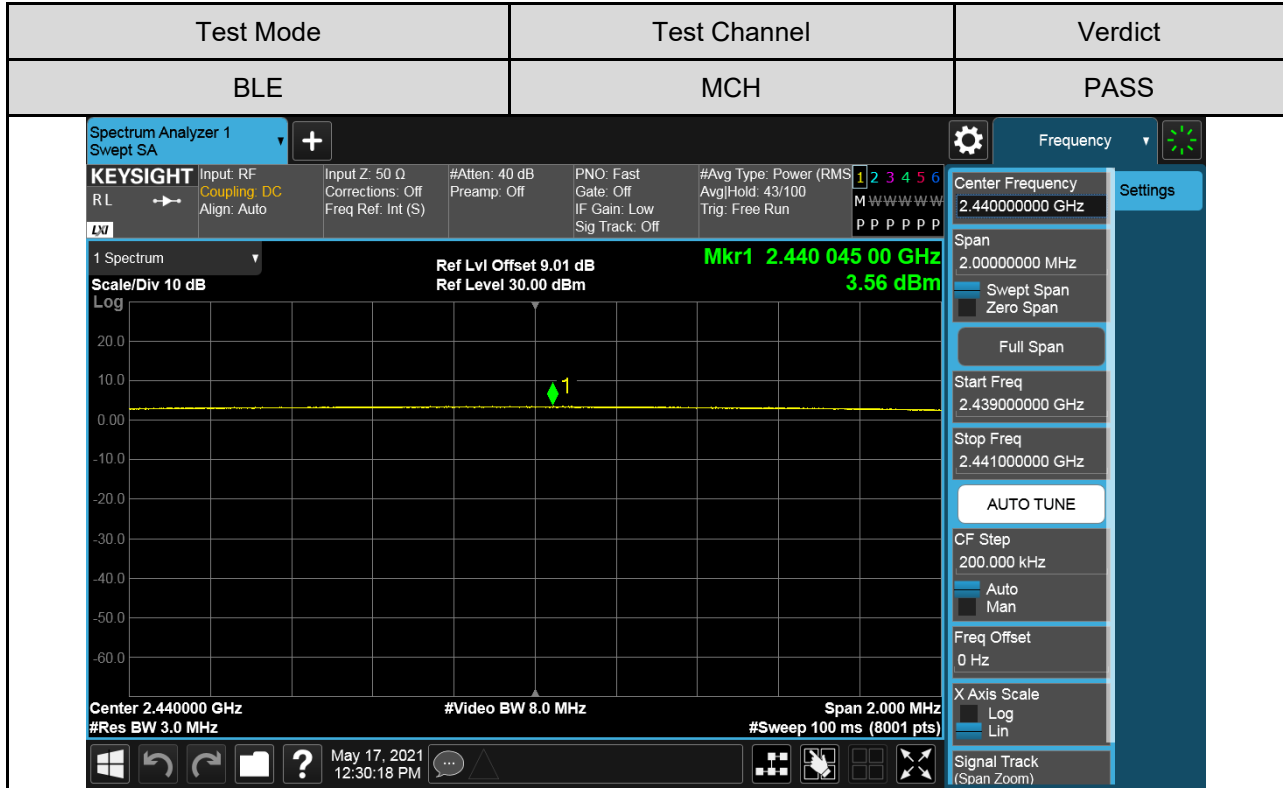



## 7.4. POWER SPECTRAL DENSITY

### LIMITS

FCC Part15 (15.247) Subpart C, ISED RSS-247 ISSUE 2			
Section	Test Item	Limit	Frequency Range (MHz)
CFR 47 FCC §15.247 (e) ISED RSS-247 5.2 (b)	Power Spectral Density	8 dBm/3 kHz	2400-2483.5

### TEST PROCEDURE

Refer to FCC KDB 558074, connect the UUT to the spectrum analyser and use the following settings:

Center Frequency	The centre frequency of the channel under test
Detector	Peak
RBW	$3 \text{ kHz} \leq \text{RBW} \leq 100 \text{ kHz}$
VBW	$\geq 3 \times \text{RBW}$
Span	1.5 x DTS bandwidth
Trace	Max hold
Sweep time	Auto couple.

Allow trace to fully stabilize and use the peak marker function to determine the maximum amplitude level within the RBW.

If measured value exceeds limit, reduce RBW (no less than 3 kHz) and repeat.

### TEST ENVIRONMENT

Temperature	22°C	Relative Humidity	56%
Atmosphere Pressure	101kPa	Test Voltage	AC120V

### TEST SETUP

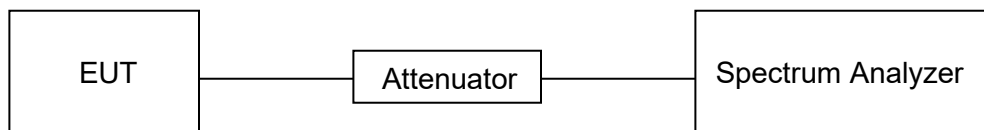



**RESULTS**

Test Mode	Test Channel	Maximum Peak power spectral density (dBm/100kHz)	Result
BLE-1M	LCH	1.31	Pass
	MCH	2.42	Pass
	HCH	3.12	Pass
BLE-2M	LCH	1.69	Pass
	MCH	1.98	Pass
	HCH	2.33	Pass



**Test Graphs:  
For 1M part:**

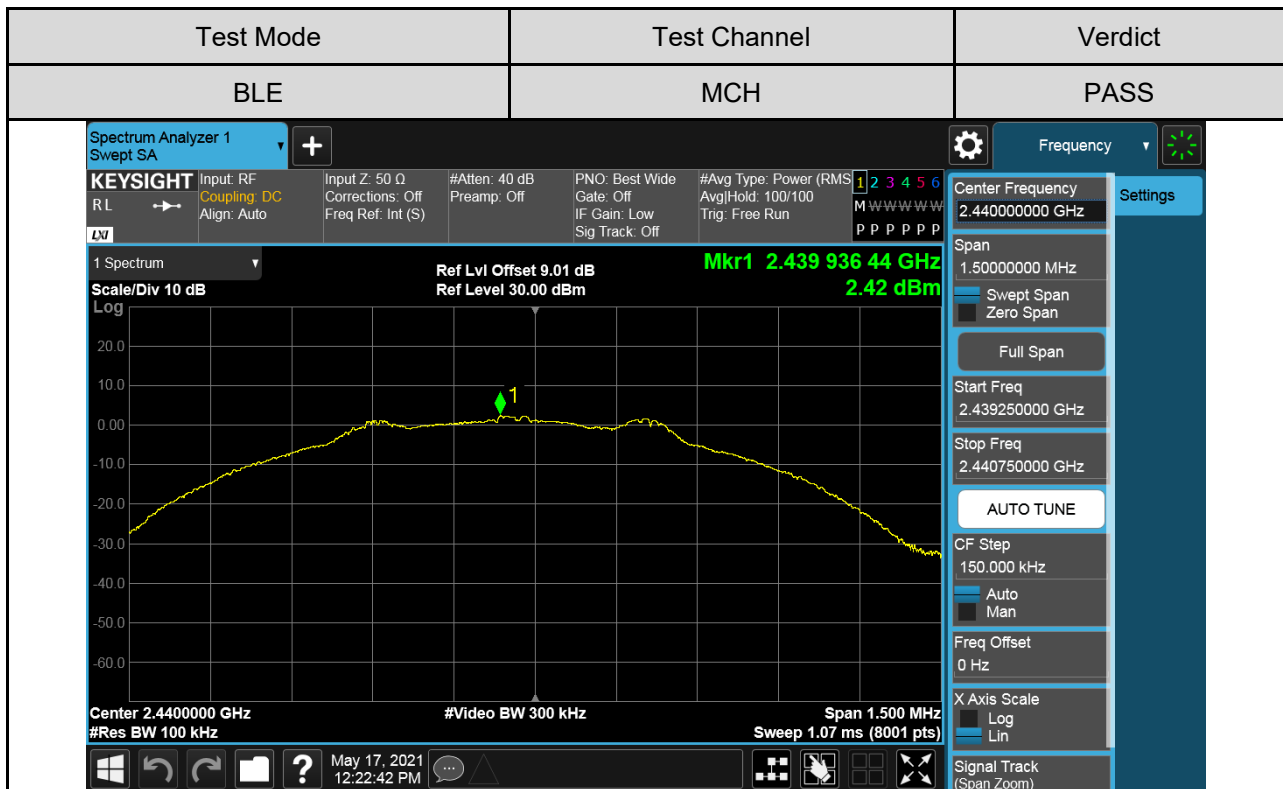
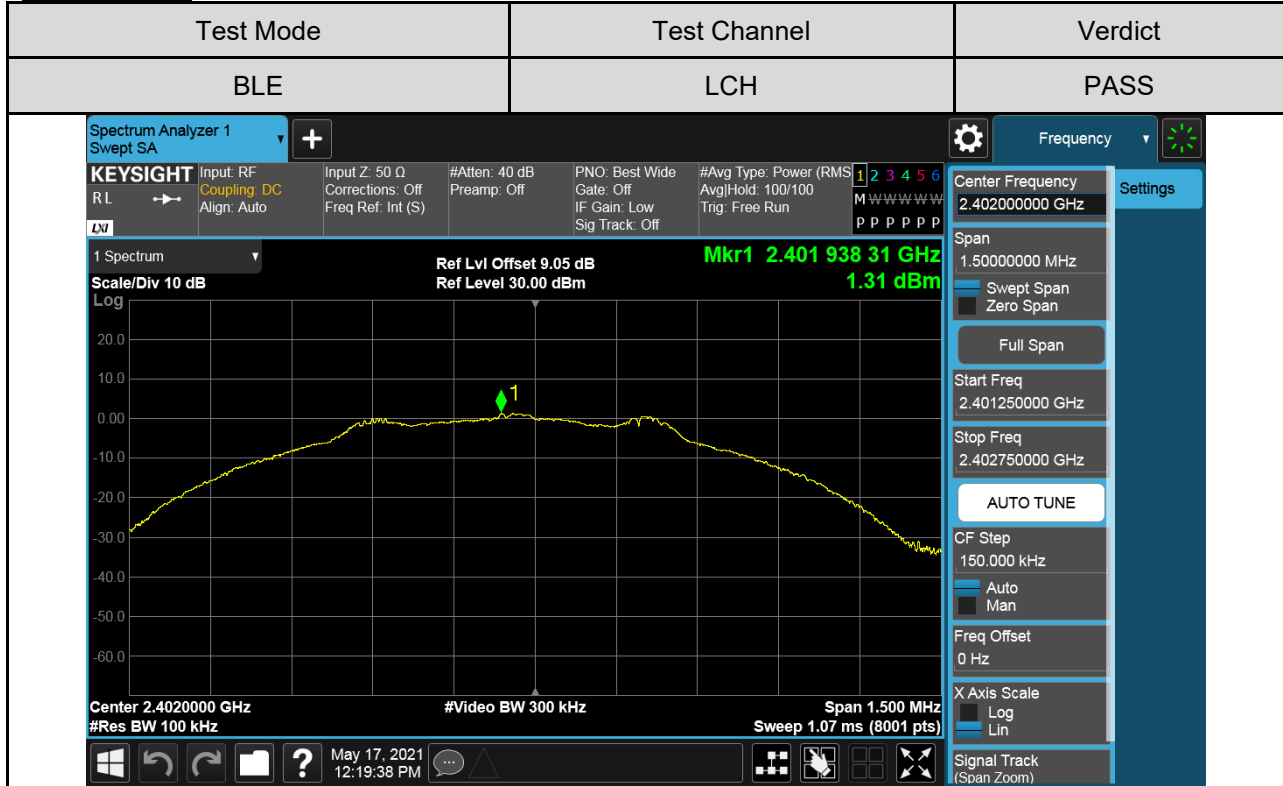

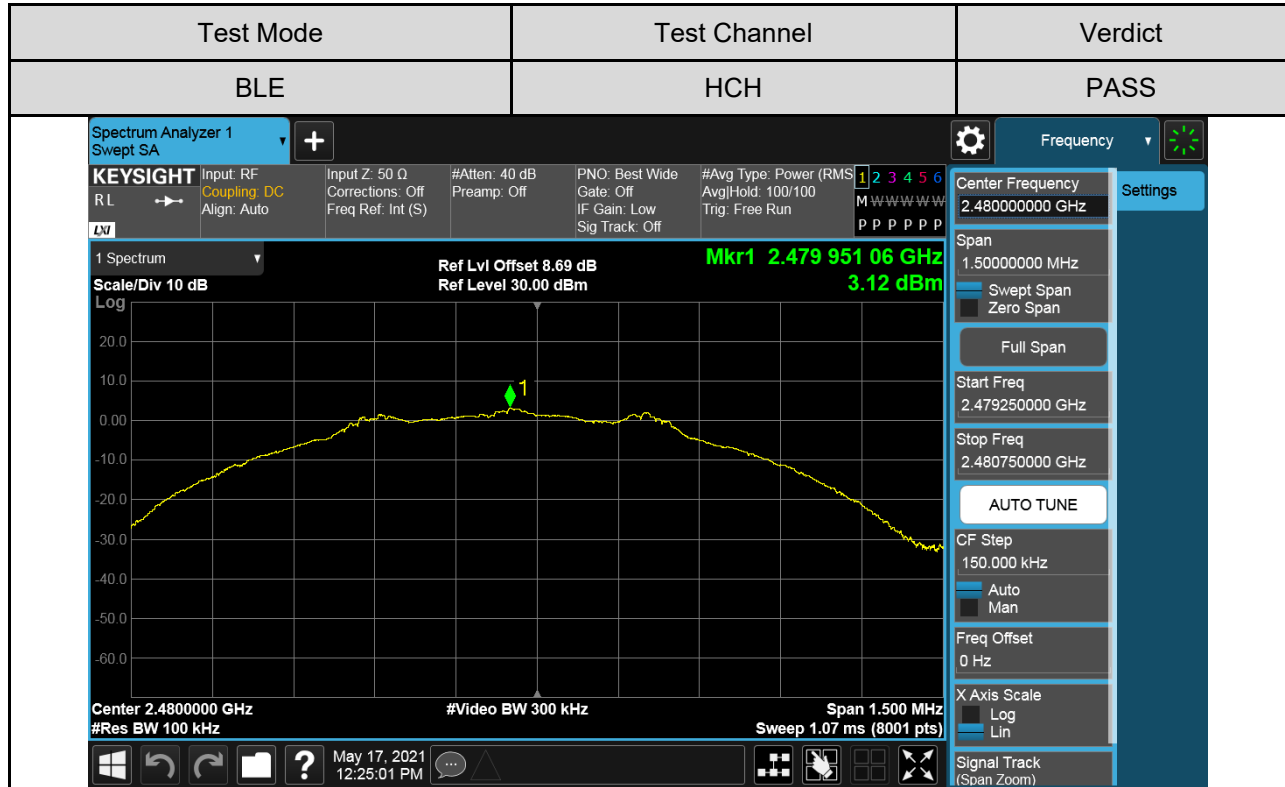

For 2M part:

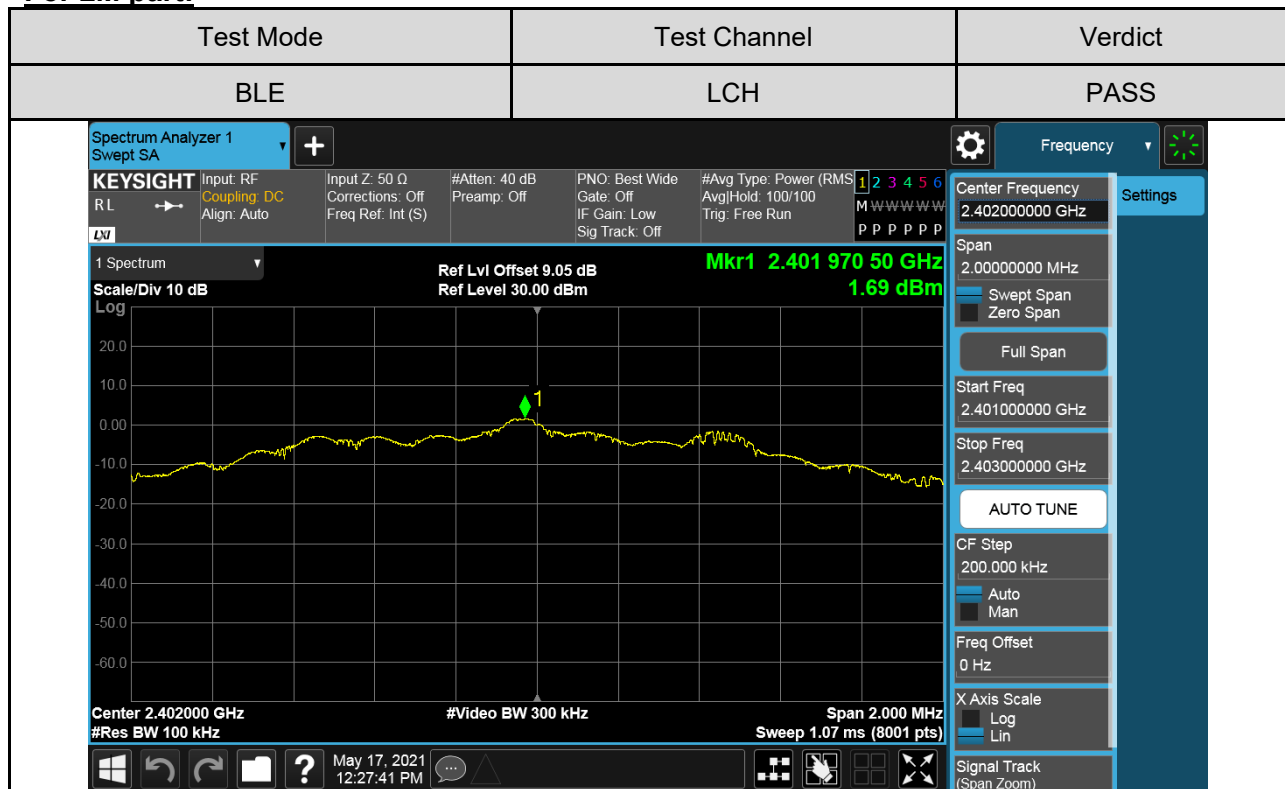

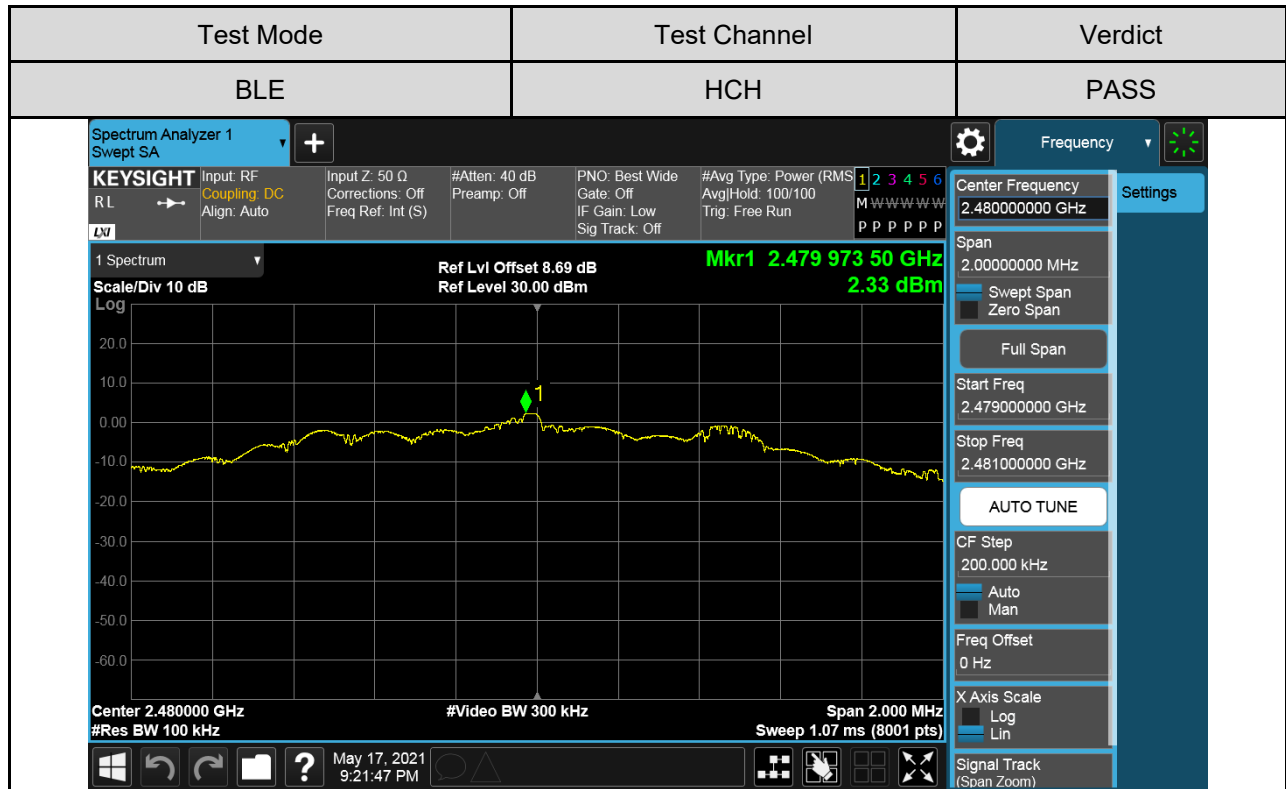
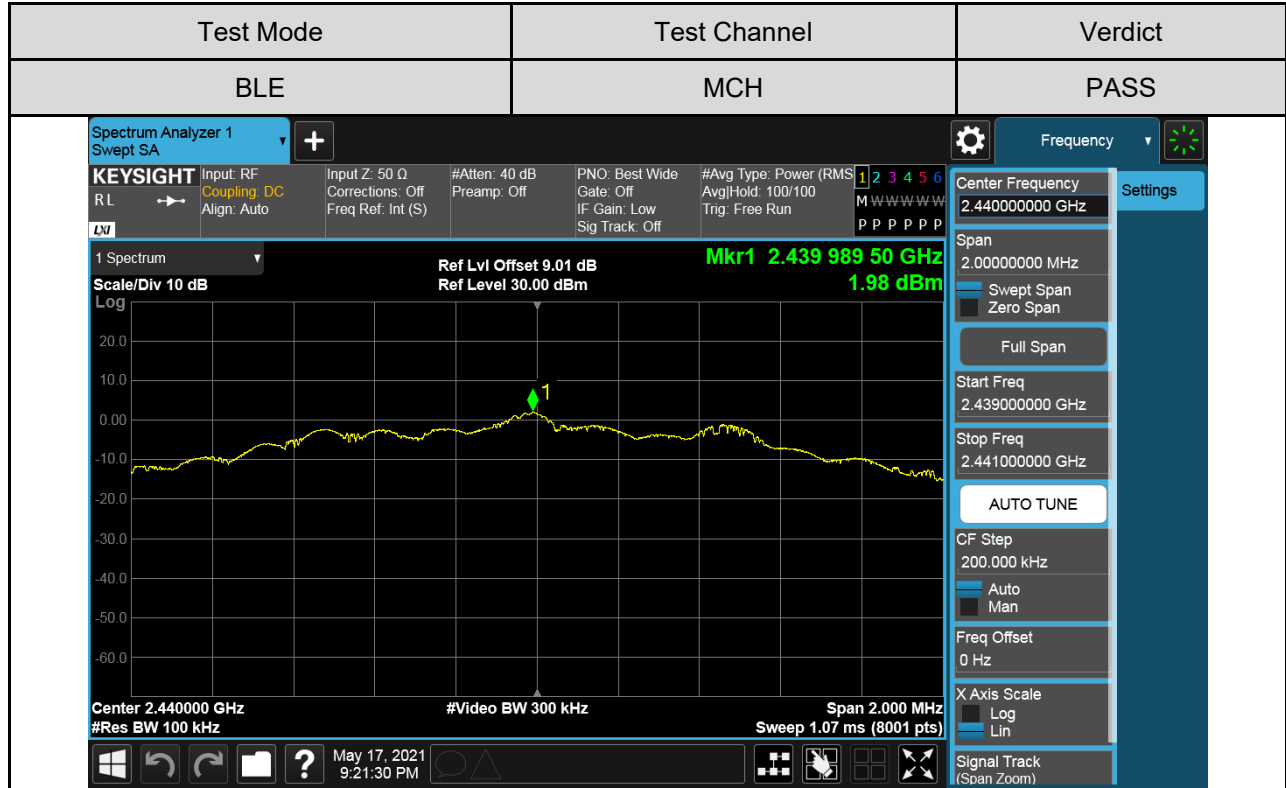

## 7.5. CONDUCTED BANDEGE AND SPURIOUS EMISSIONS

### LIMITS

FCC Part15 (15.247) Subpart C, ISED RSS-247 ISSUE 2		
Section	Test Item	Limit
CFR 47 FCC §15.247 (d) ISED RSS-247 5.5	Conducted Bandedge and Spurious Emissions	at least 20 dB below that in the 100 kHz bandwidth within the band that contains the highest level of the desired power

### TEST PROCEDURE

Connect the UUT to the spectrum analyser and use the following settings:

Center Frequency	The centre frequency of the channel under test
Detector	Peak
RBW	100K
VBW	$\geq 3 \times \text{RBW}$
Span	1.5 x DTS bandwidth
Trace	Max hold
Sweep time	Auto couple.

Use the peak marker function to determine the maximum PSD level.

Span	Set the center frequency and span to encompass frequency range to be measured
Detector	Peak
RBW	100K
VBW	$\geq 3 \times \text{RBW}$
measurement points	$\geq \text{span}/\text{RBW}$
Trace	Max hold
Sweep time	Auto couple.

Use the peak marker function to determine the maximum amplitude level.

### TEST SETUP

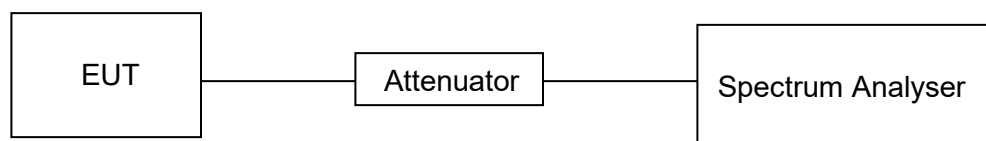



**TEST ENVIRONMENT**

Temperature	22°C	Relative Humidity	56%
Atmosphere Pressure	101kPa	Test Voltage	AC120V

**Part I :Conducted Bandedge**

**RESULTS TABLE**

Test Mode	Test Channel	Carrier Power[dBm]	Max. Spurious Level [dBm]	Limit [dBm]	Verdict
BLE-1M	LCH	1.449	-41.04	-18.55	PASS
	HCH	3.256	-41.19	-16.74	PASS
BLE-2M	LCH	0.5567	-41.30	-19.44	PASS
	HCH	3.706	-40.03	-16.29	PASS



**TEST GRAPHS**

For 1M part:

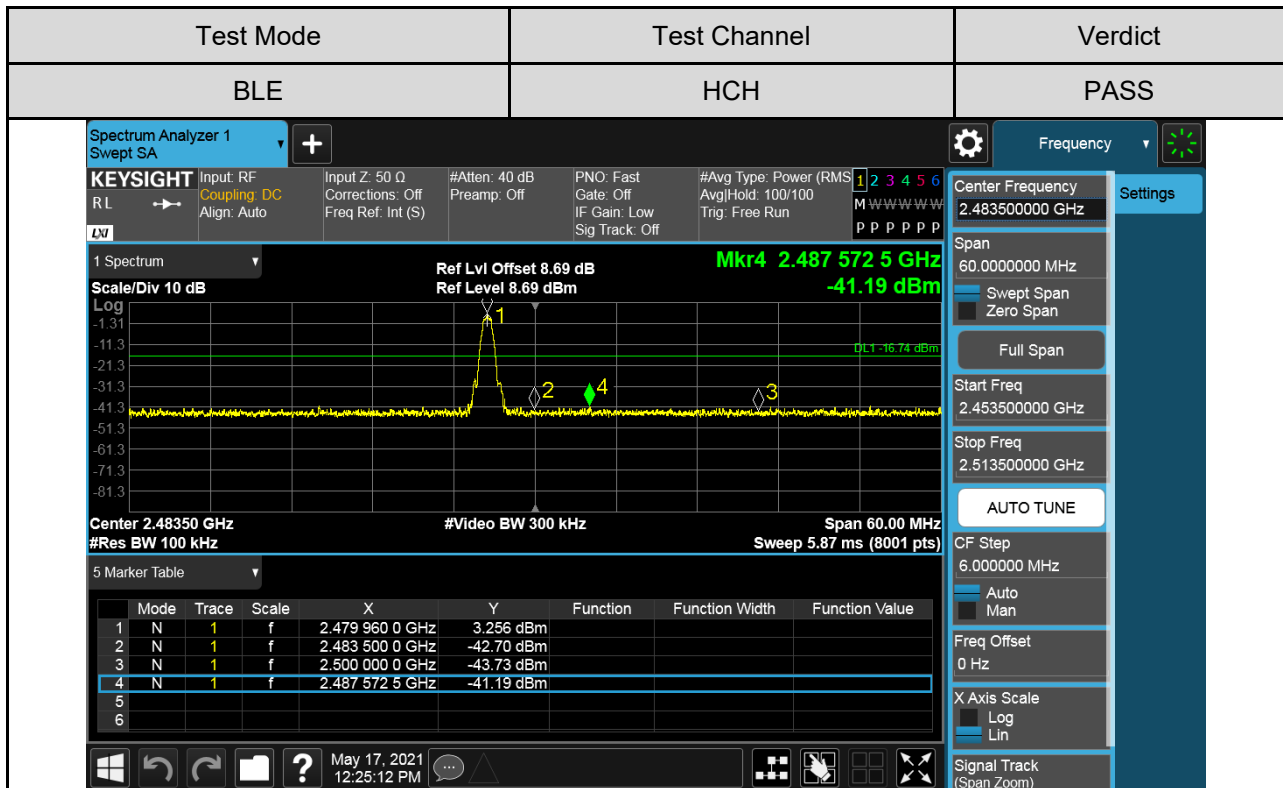
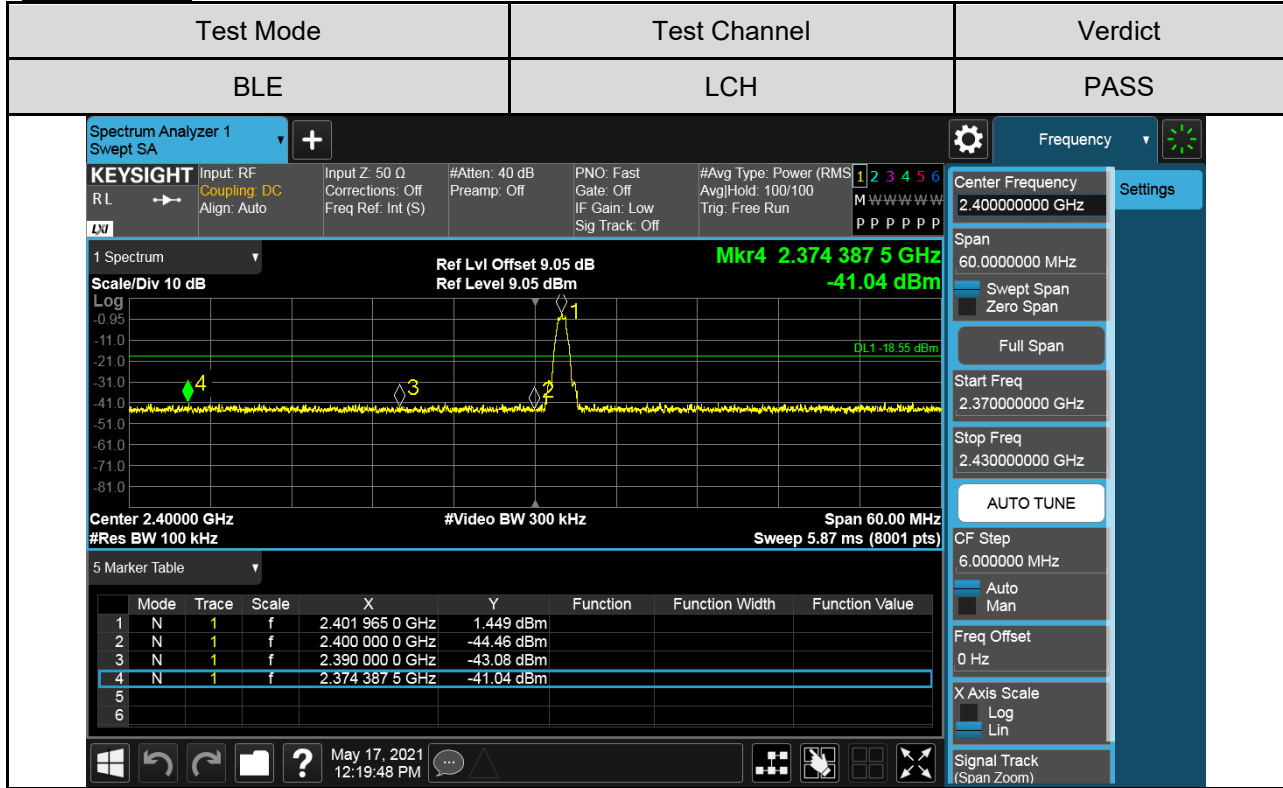



For 2M part:

Test Mode	Test Channel	Verdict
BLE	LCH	PASS

**KEYSIGHT** Spectrum Analyzer 1 Swept SA

Input: RF, Coupling: DC, Align: Auto, Input Z: 50 Ω, Corrections: Off, Freq Ref: Int (S), #Atten: 40 dB, Preamp: Off, PNO: Fast, Gate: Off, IF Gain: Low, Sig Track: Off, #Avg Type: Power (RMS), Avg/Hold: 100/100, Trig: Free Run

Center Frequency: 2.40000000 GHz  
Span: 60.0000000 MHz  
Start Freq: 2.370000000 GHz  
Stop Freq: 2.430000000 GHz

Scale/Div 10 dB  
Ref Lvl Offset 9.05 dB  
Ref Level 9.05 dBm  
Mkr4 2.380 402 5 GHz  
-41.30 dBm

Center 2.40000 GHz  
#Res BW 100 kHz  
#Video BW 300 kHz  
Span 60.00 MHz  
Sweep 5.87 ms (8001 pts)

Mode	Trace	Scale	X	Y	Function	Function Width	Function Value
1	N	1	f	2.401 972 5 GHz			0.5567 dBm
2	N	1	f	2.400 000 0 GHz			-41.34 dBm
3	N	1	f	2.390 000 0 GHz			-43.68 dBm
4	N	1	f	2.380 402 5 GHz			-41.30 dBm
5							
6							

Test Mode	Test Channel	Verdict
BLE	HCH	PASS

**KEYSIGHT** Spectrum Analyzer 1 Swept SA

Input: RF, Coupling: DC, Align: Auto, Input Z: 50 Ω, Corrections: Off, Freq Ref: Int (S), #Atten: 40 dB, Preamp: Off, PNO: Fast, Gate: Off, IF Gain: Low, Sig Track: Off, #Avg Type: Power (RMS), Avg/Hold: 100/100, Trig: Free Run

Center Frequency: 2.48350000 GHz  
Span: 60.0000000 MHz  
Start Freq: 2.453500000 GHz  
Stop Freq: 2.513500000 GHz

Scale/Div 10 dB  
Ref Lvl Offset 8.69 dB  
Ref Level 8.69 dBm  
Mkr4 2.494 045 0 GHz  
-40.03 dBm

Center 2.48350 GHz  
#Res BW 100 kHz  
#Video BW 300 kHz  
Span 60.00 MHz  
Sweep 5.87 ms (8001 pts)

Mode	Trace	Scale	X	Y	Function	Function Width	Function Value
1	N	1	f	2.479 967 5 GHz			3.706 dBm
2	N	1	f	2.483 500 0 GHz			-43.95 dBm
3	N	1	f	2.500 000 0 GHz			-44.80 dBm
4	N	1	f	2.494 045 0 GHz			-40.03 dBm
5							
6							



**Part II :Conducted Emission**

Test Result Table

Test Mode	Channel	Pref(dBm)	Puw(dBm)	Verdict
BLE-1M	LCH	1.21	<Limit	PASS
	MCH	2.58	<Limit	PASS
	HCH	2.73	<Limit	PASS
BLE-2M	LCH	1.39	<Limit	PASS
	MCH	2.79	<Limit	PASS
	HCH	3.06	<Limit	PASS

**Test Plots**

**For 1M part:**

Test Mode	Channel	Verdict
BLE	LCH	PASS

Pref test Plot

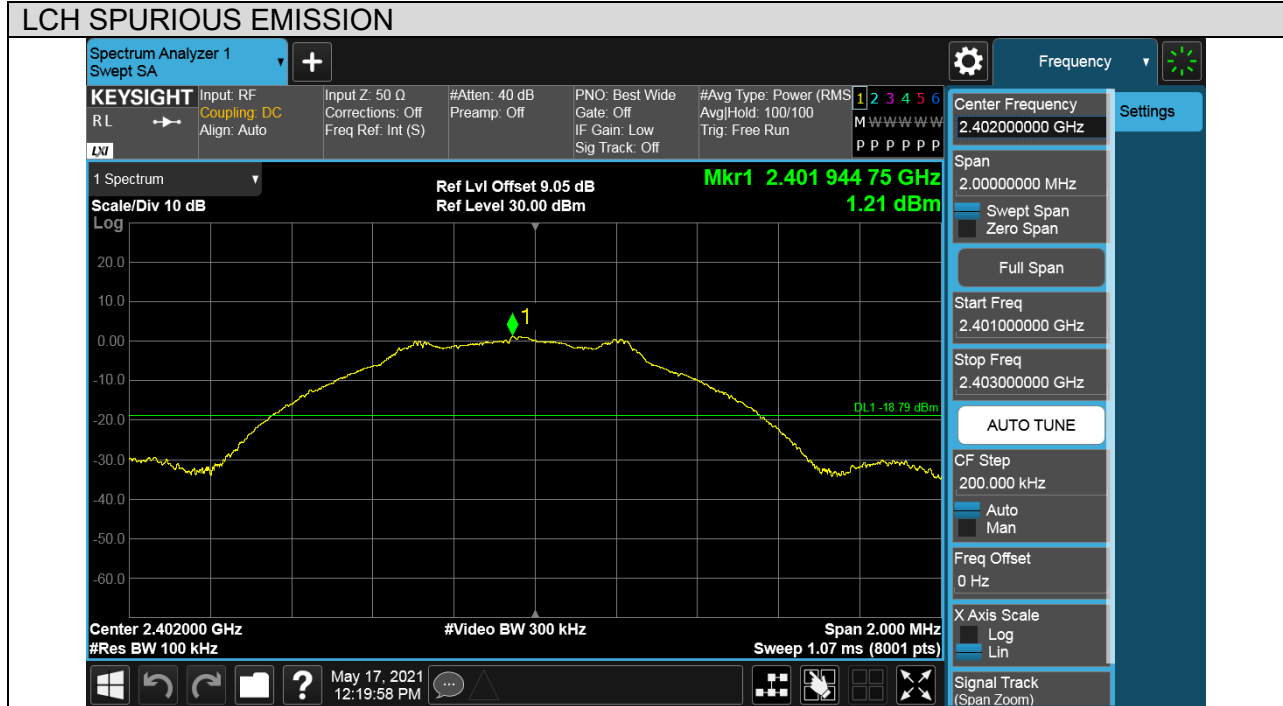



Puw test Plot

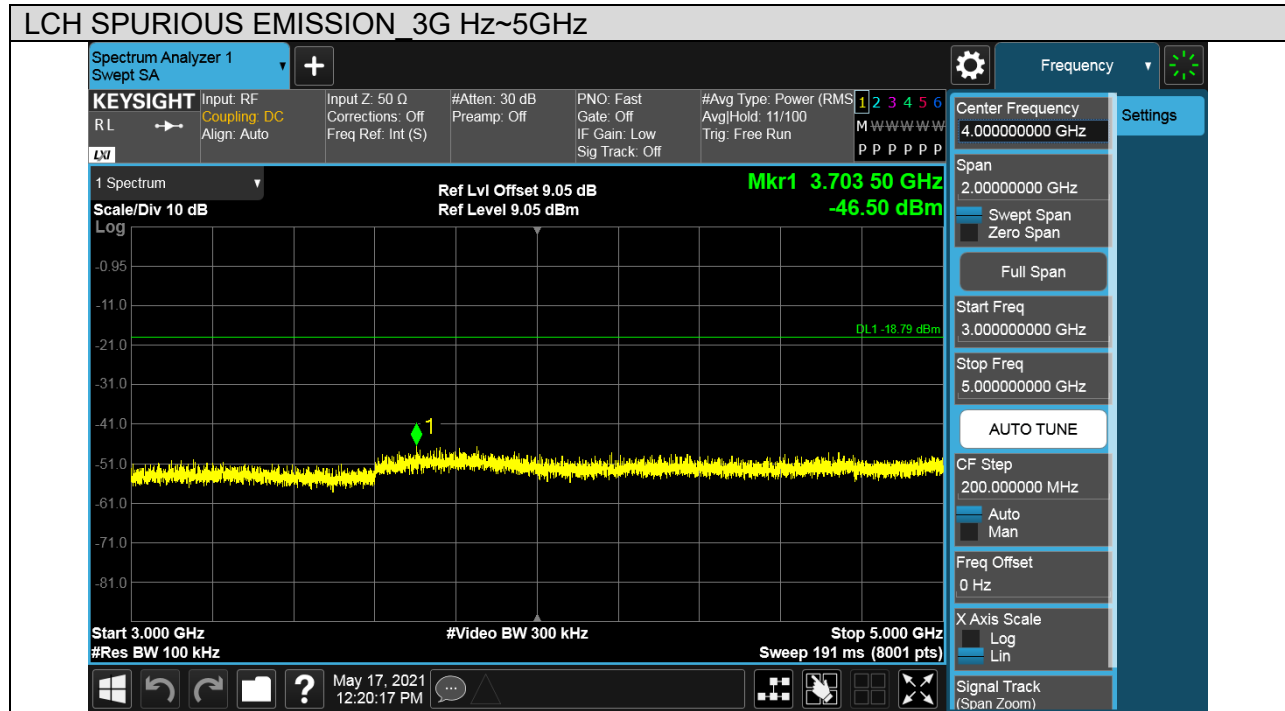
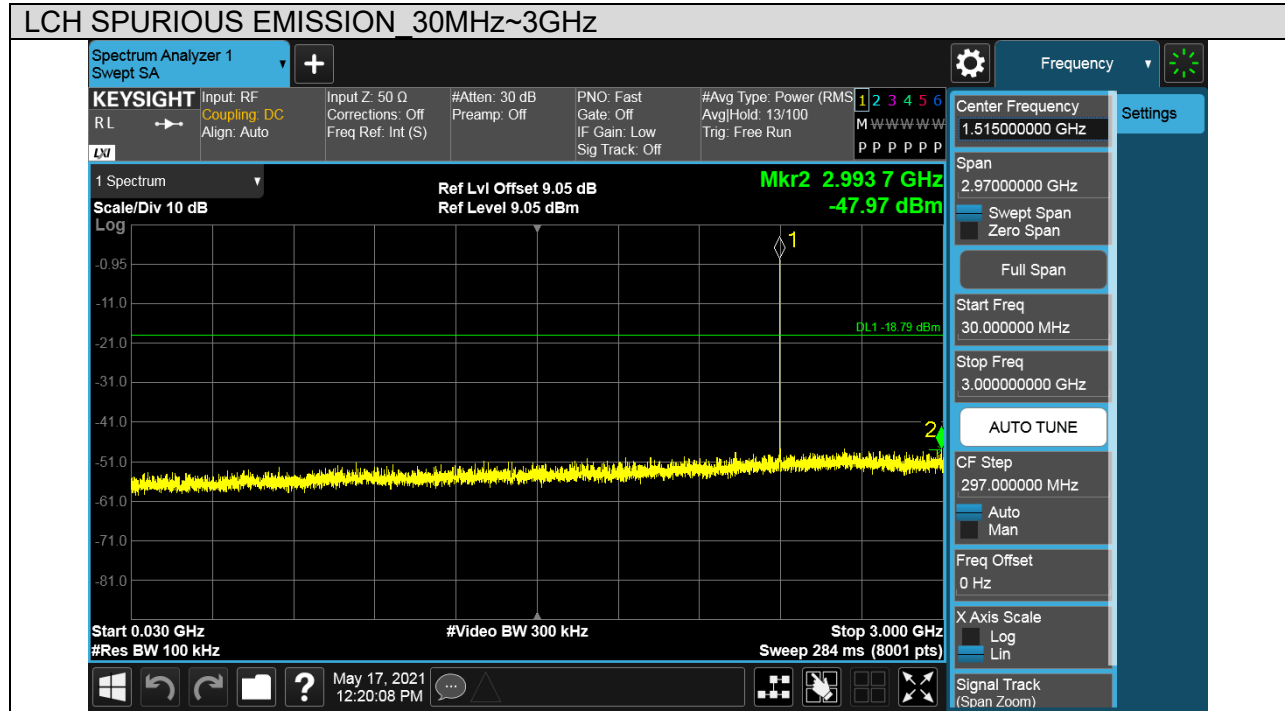

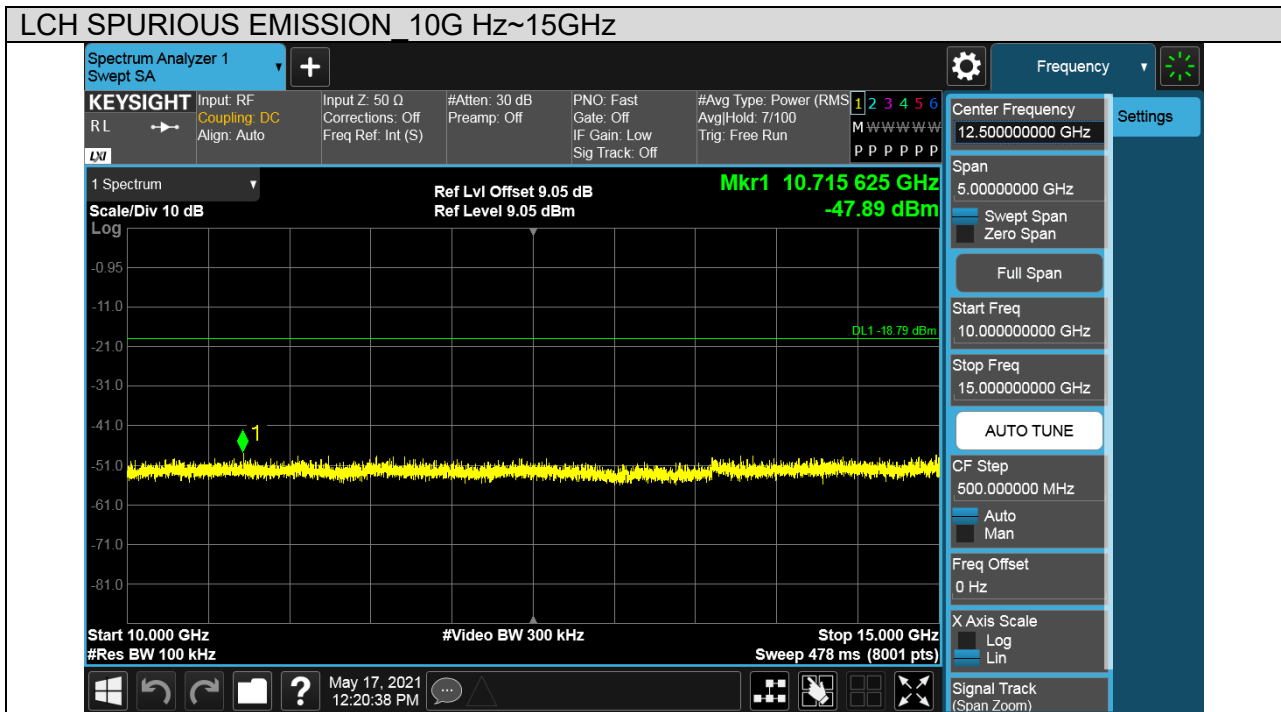
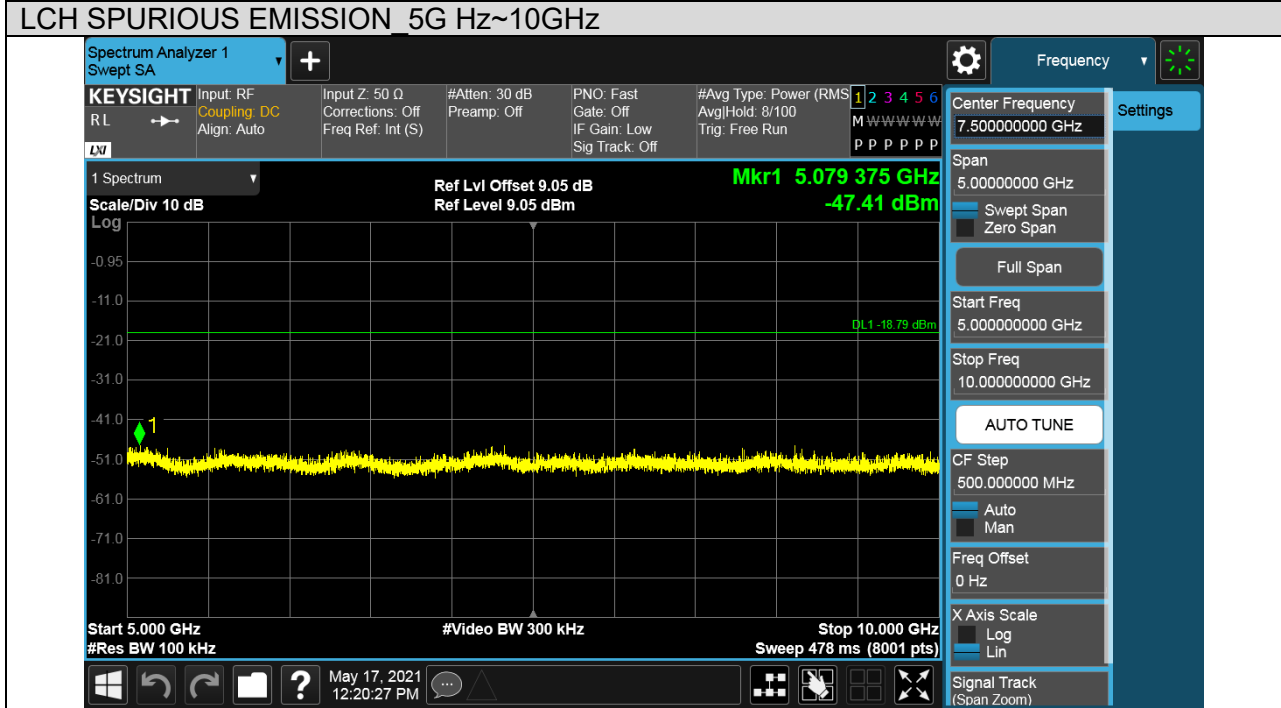

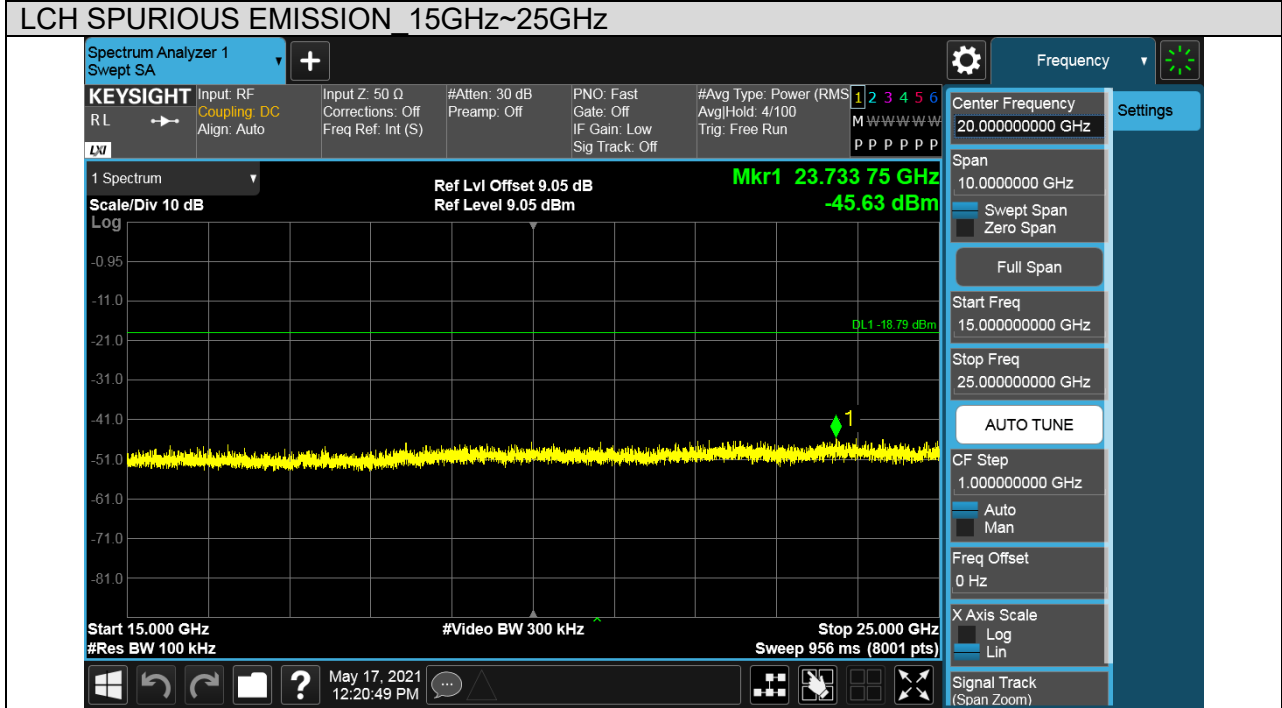



Test Mode	Channel	Verdict
BLE	MCH	PASS

Pref test Plot

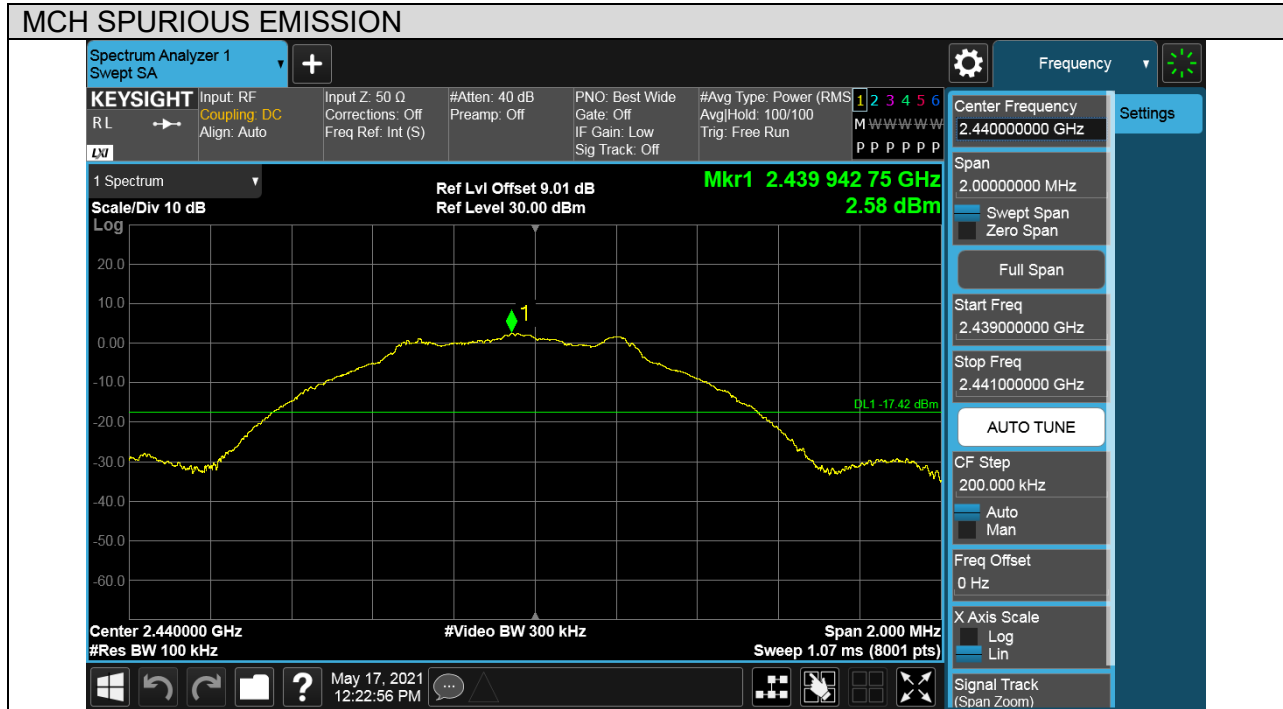



Puw test Plot

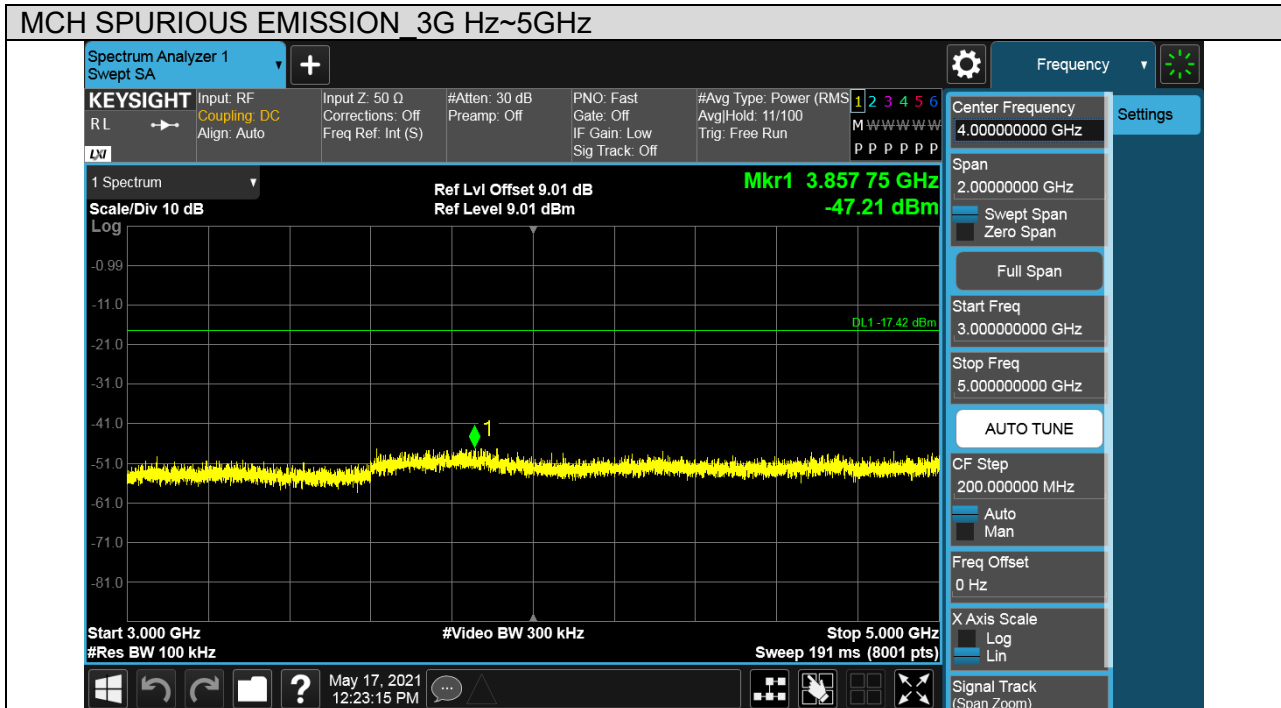
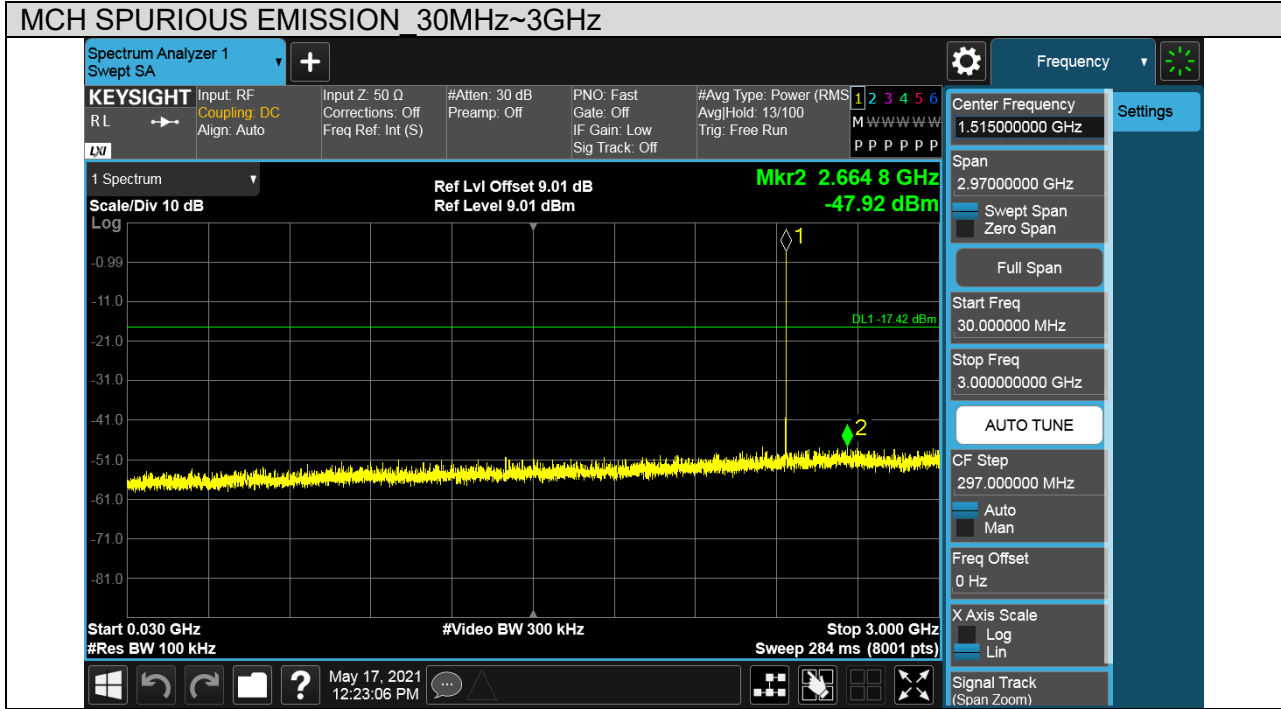

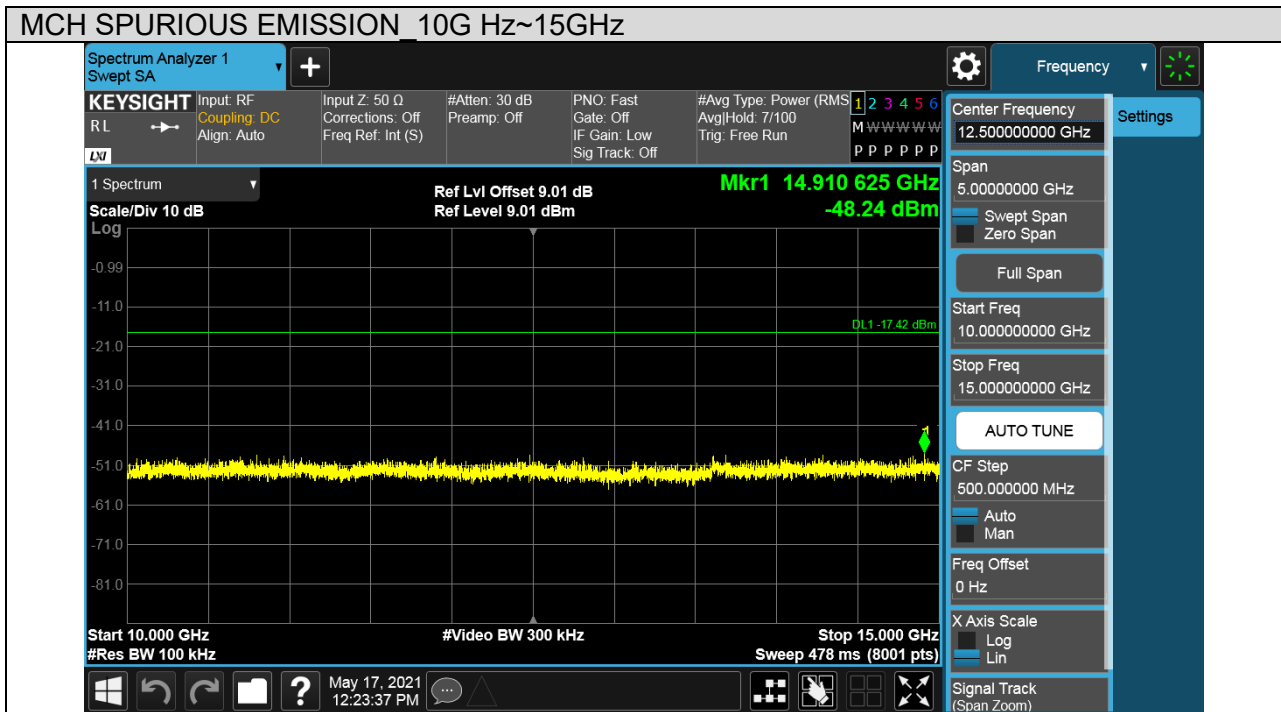
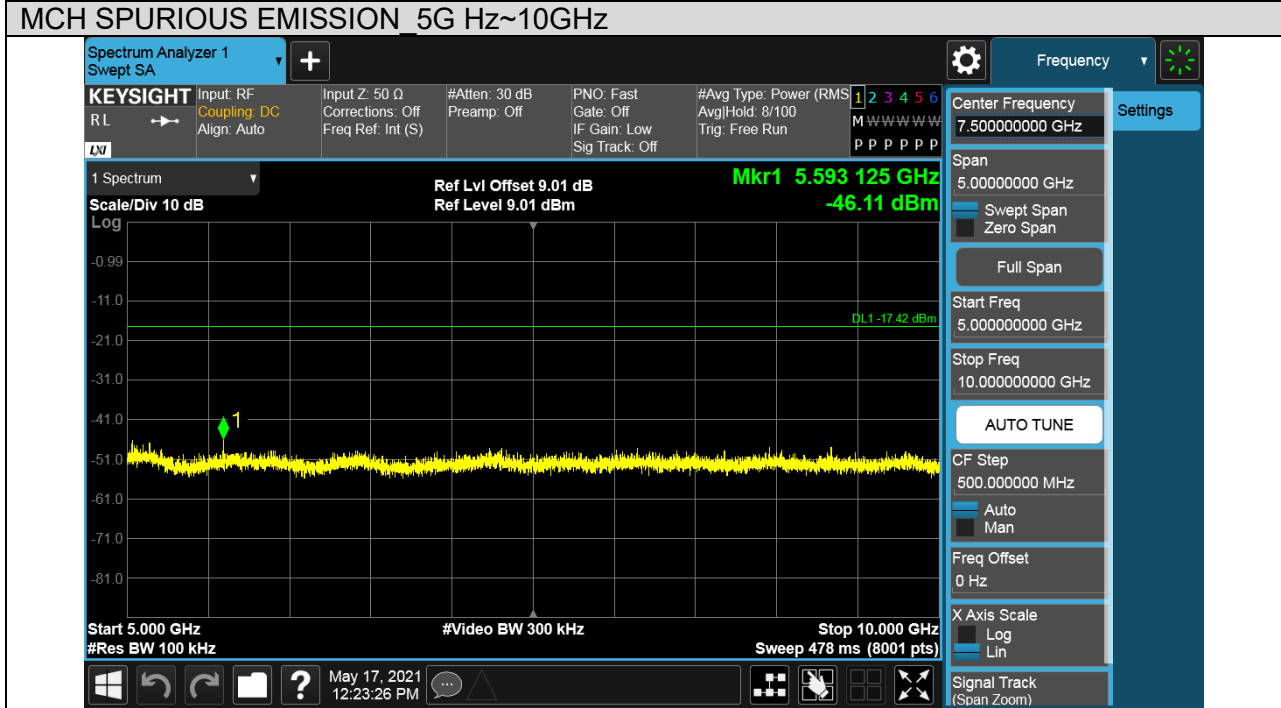

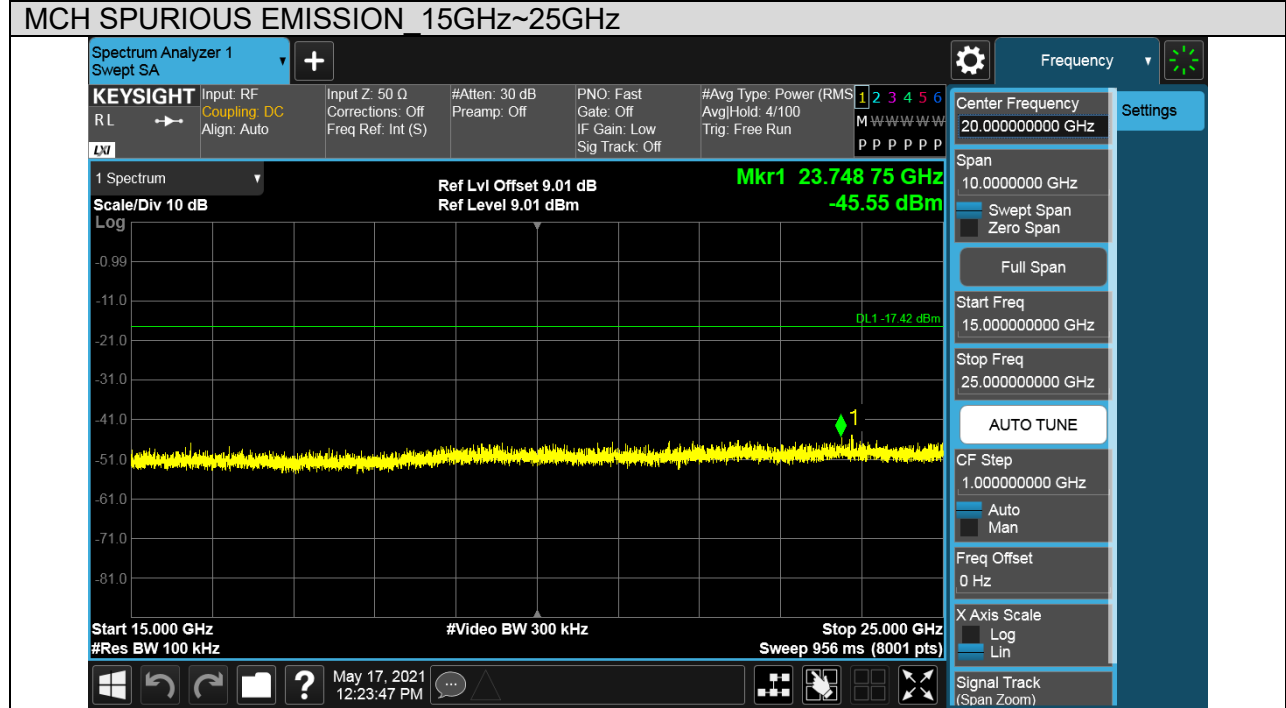



Test Mode	Channel	Verdict
BLE	HCH	PASS

Pref test Plot

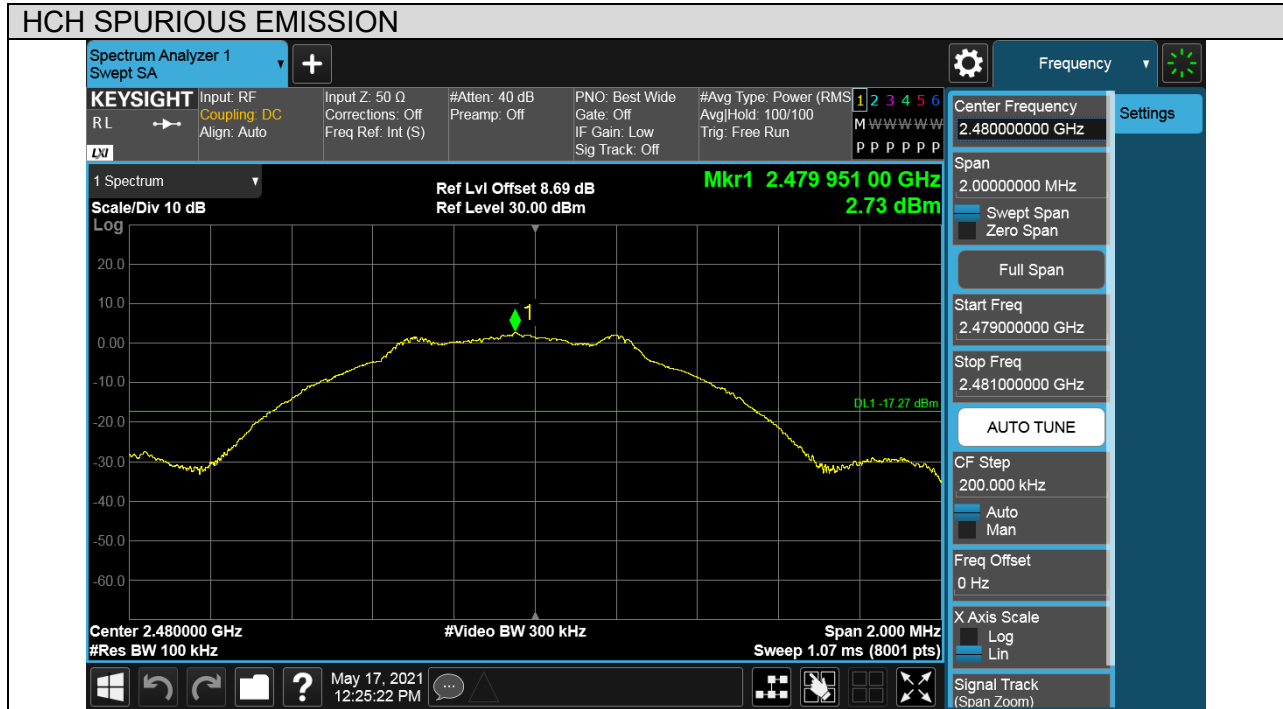



Puw test Plot

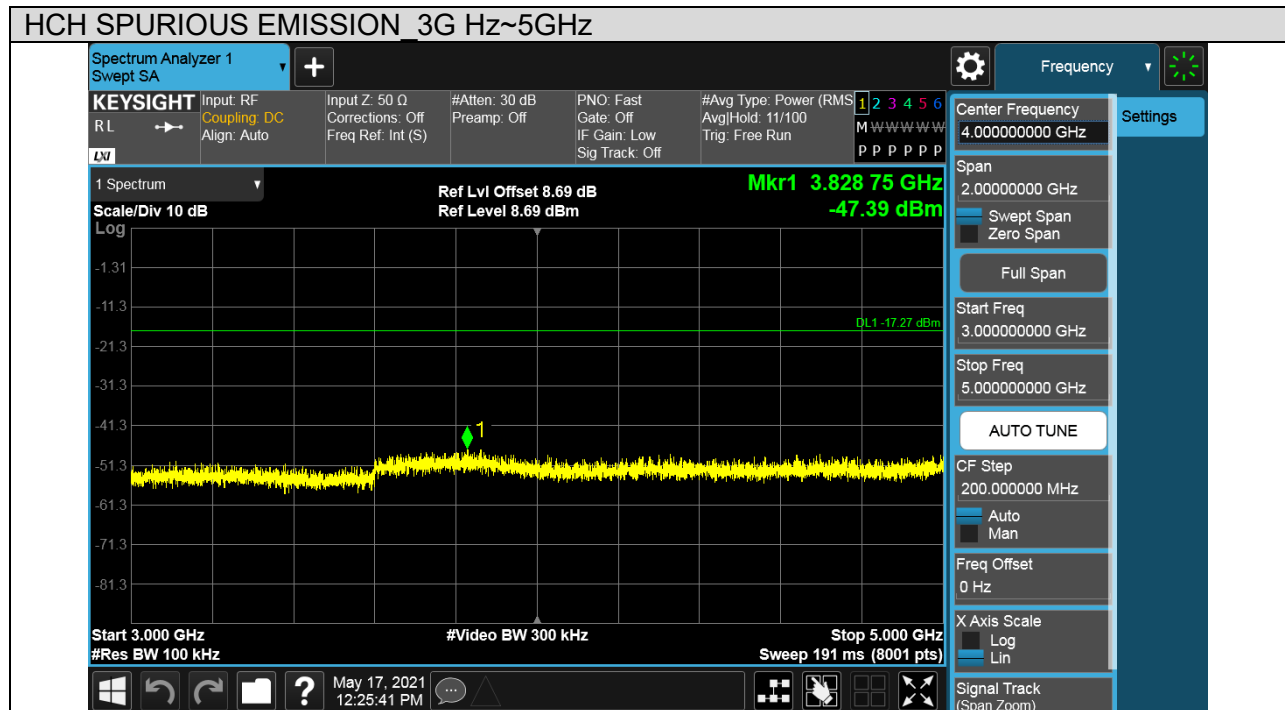
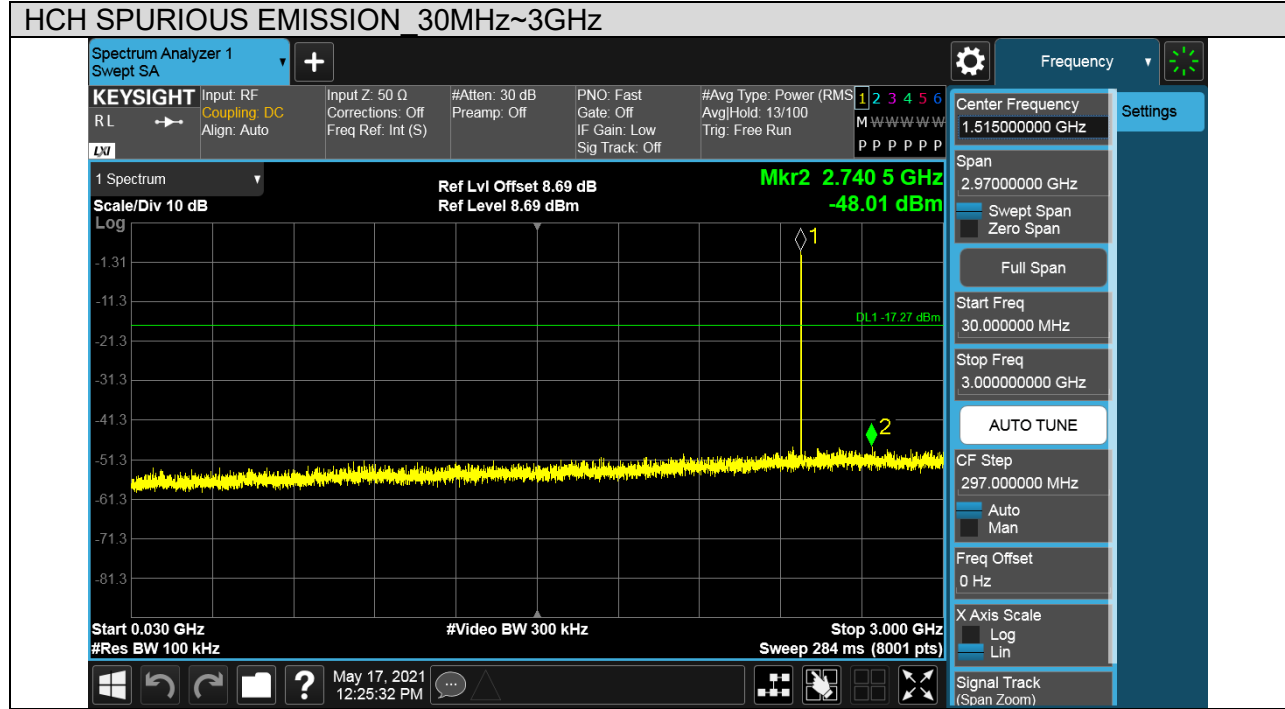

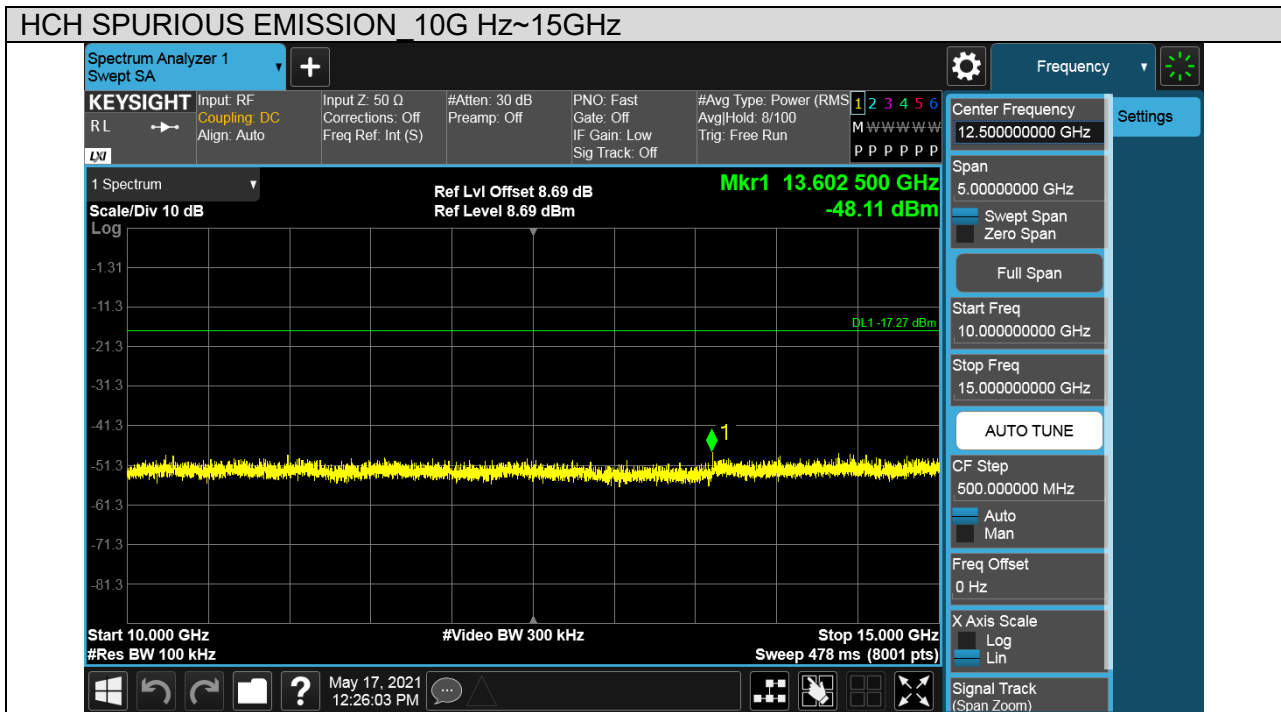
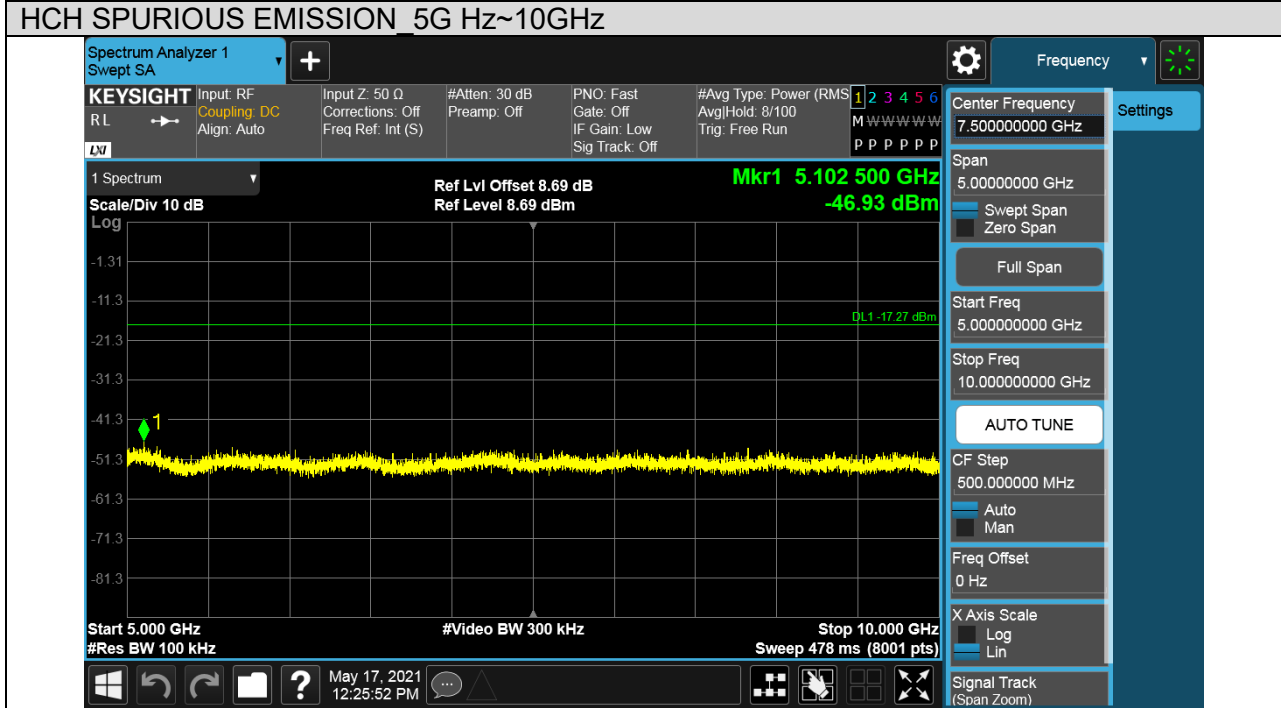

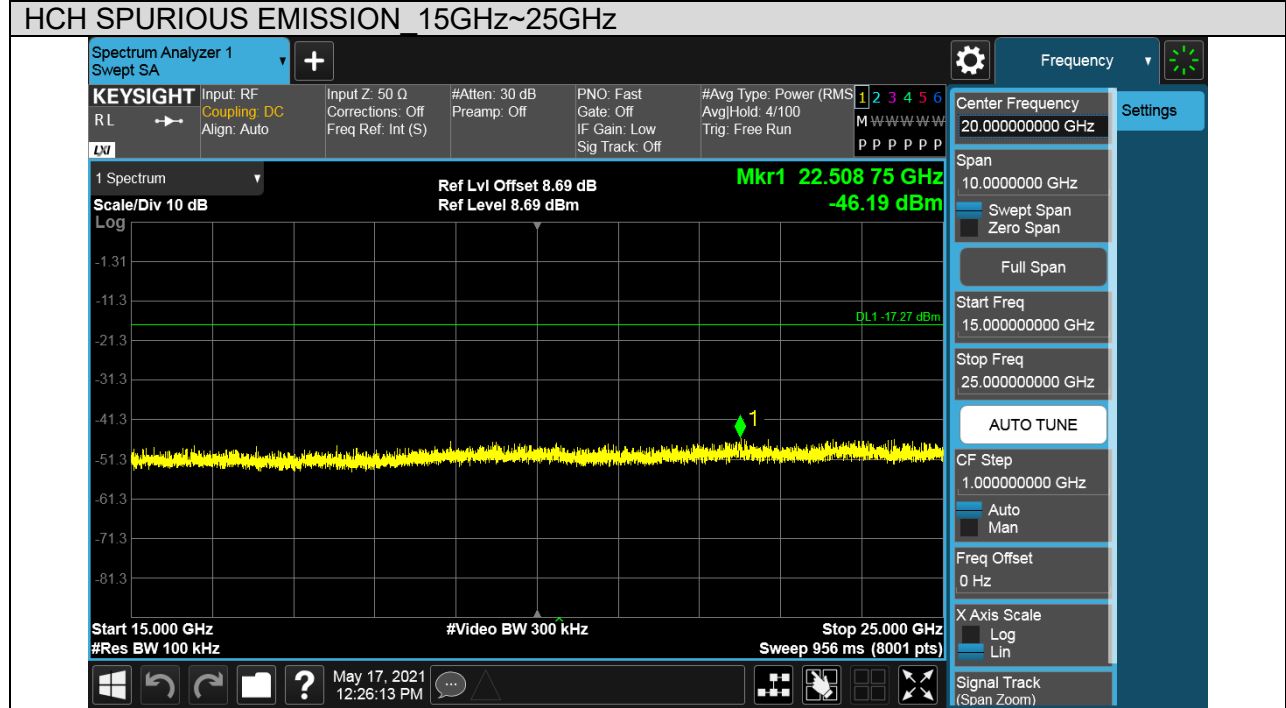



**For 2M part:**

Test Mode	Channel	Verdict
BLE	LCH	PASS

**Pref test Plot**

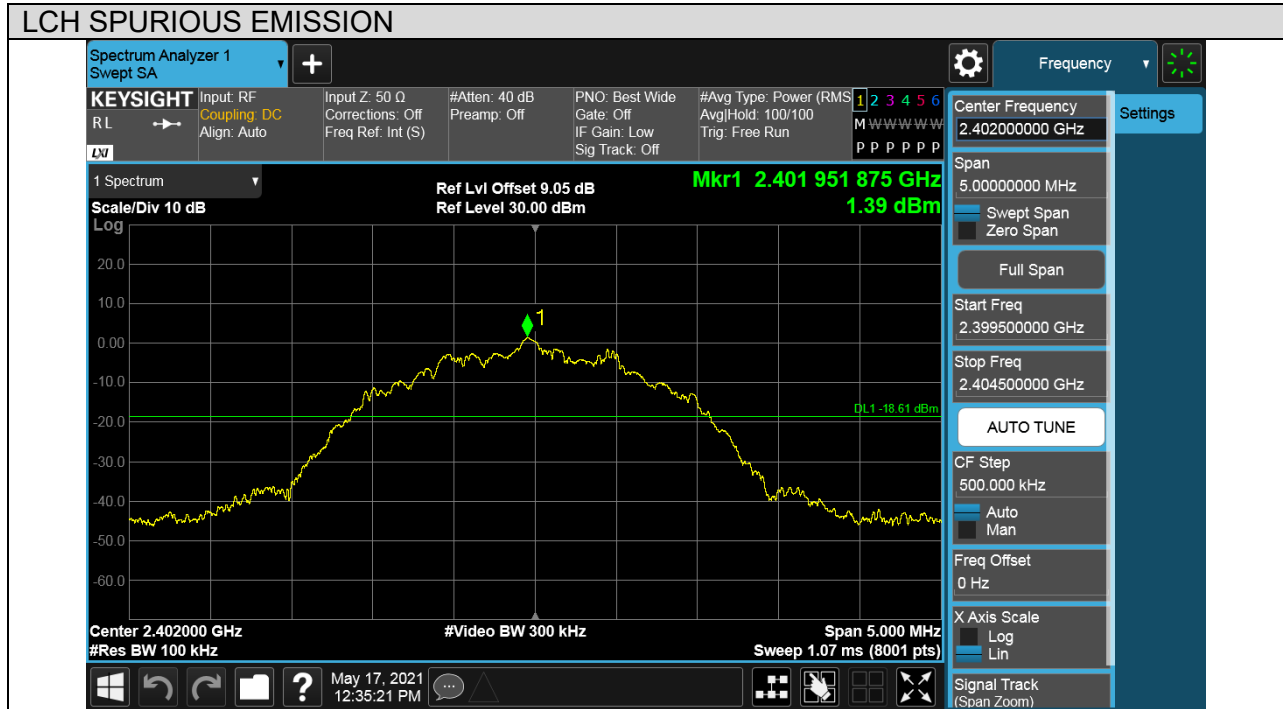



Puw test Plot

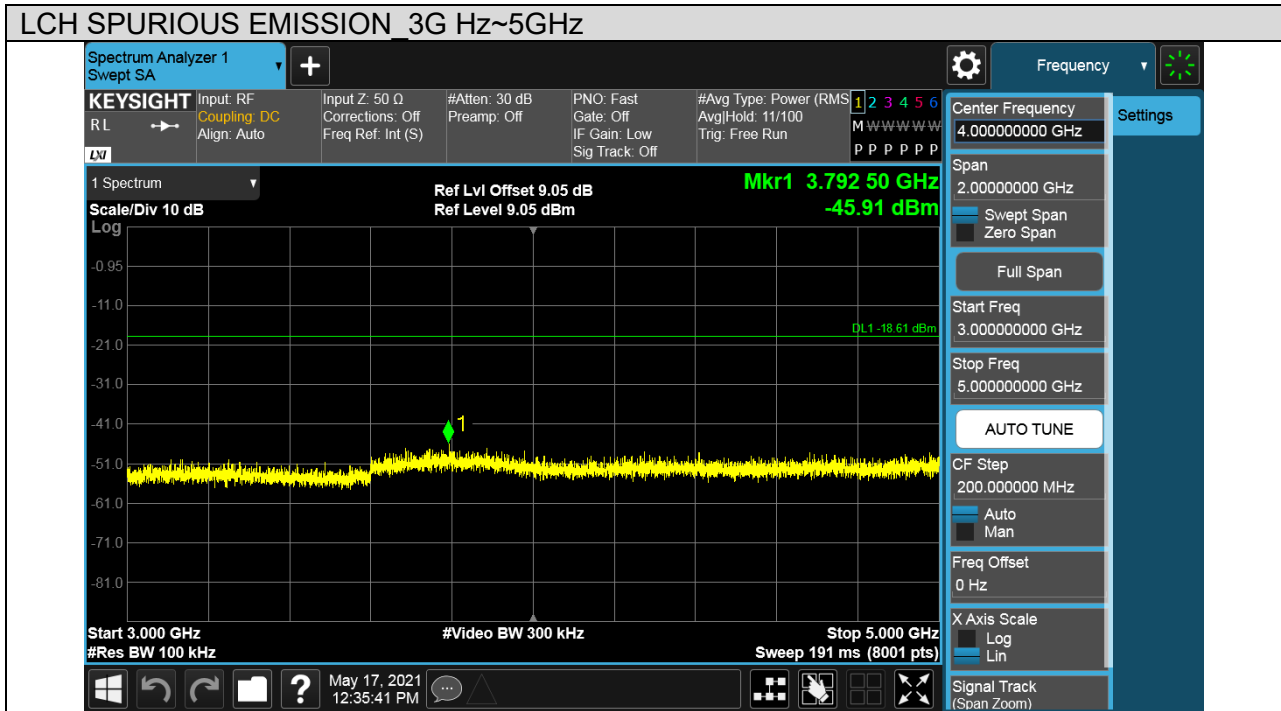
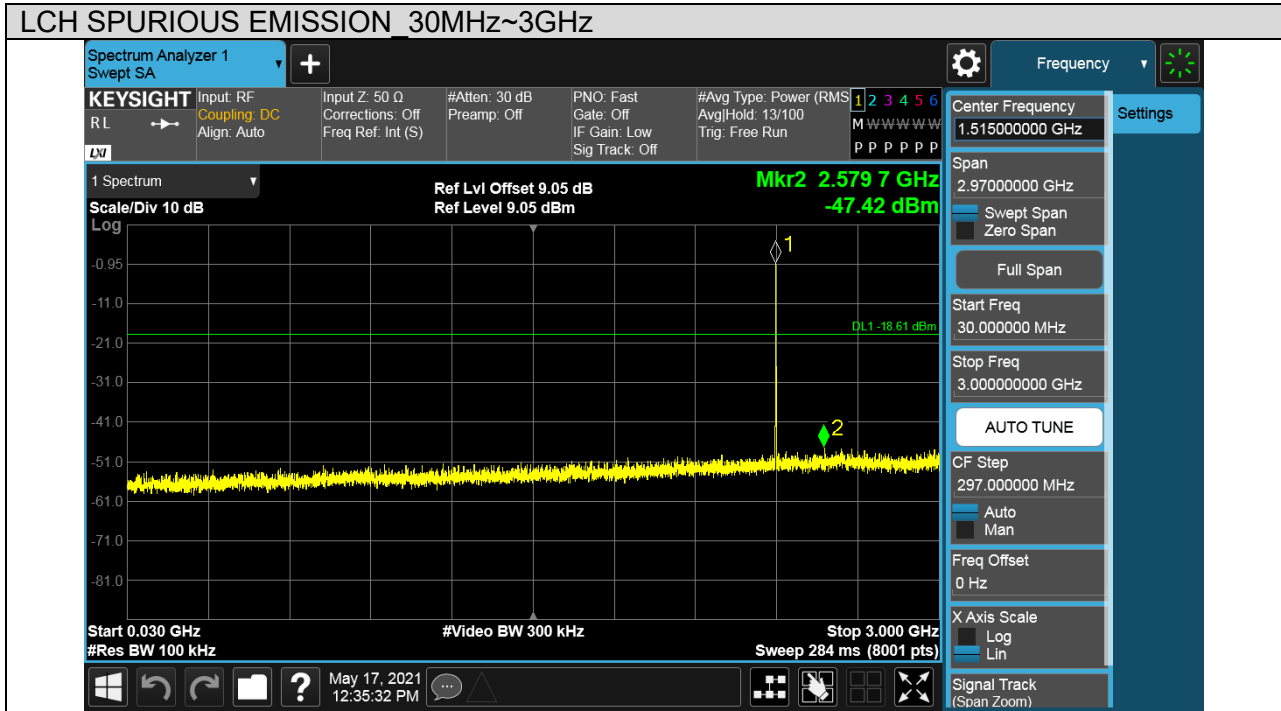

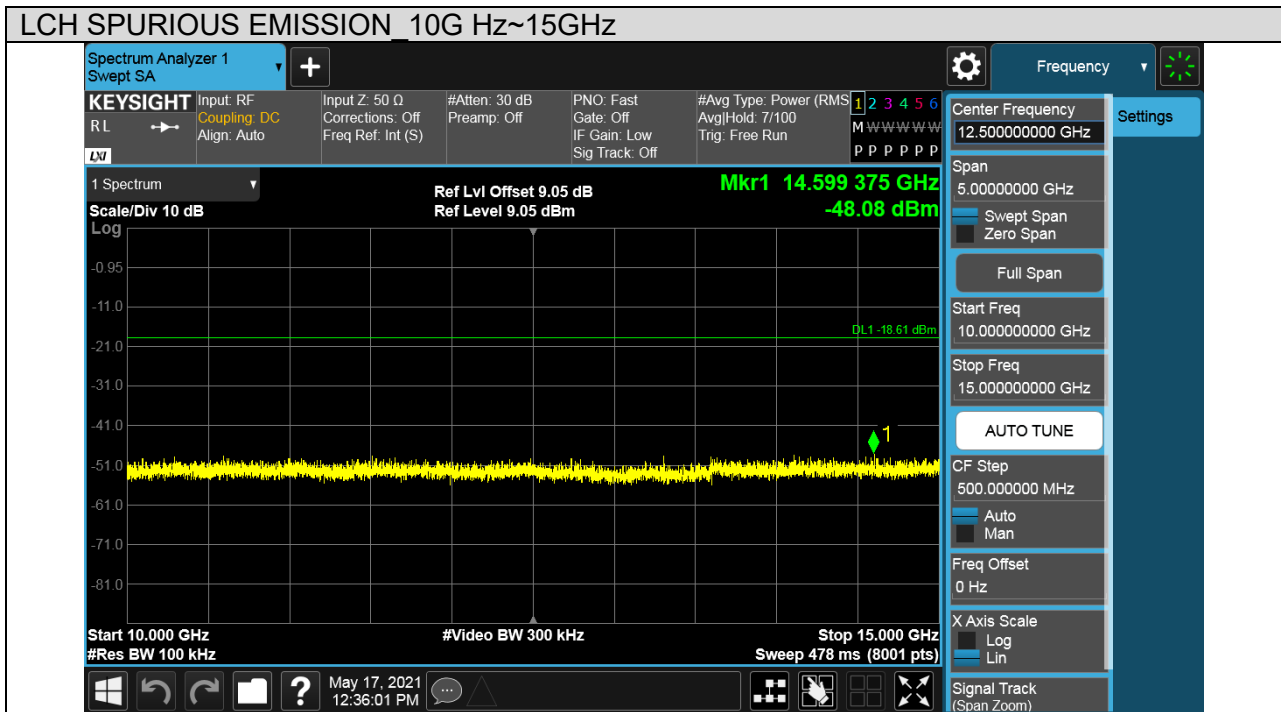
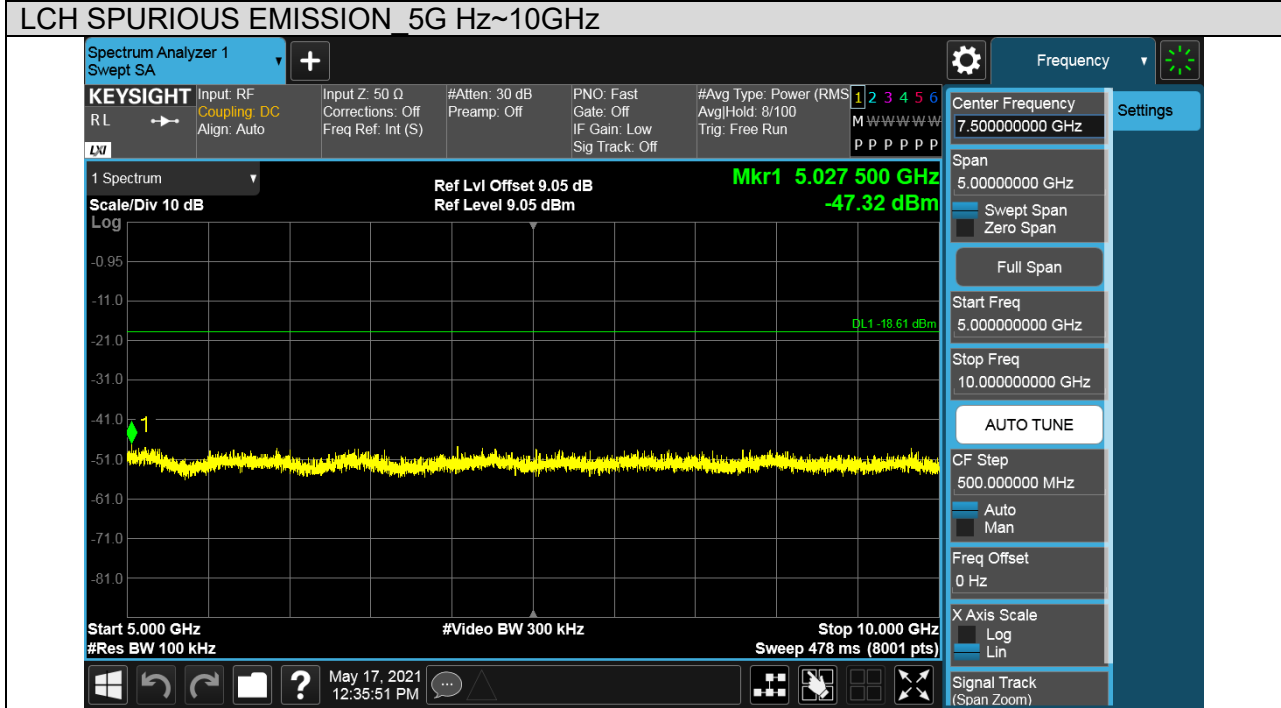

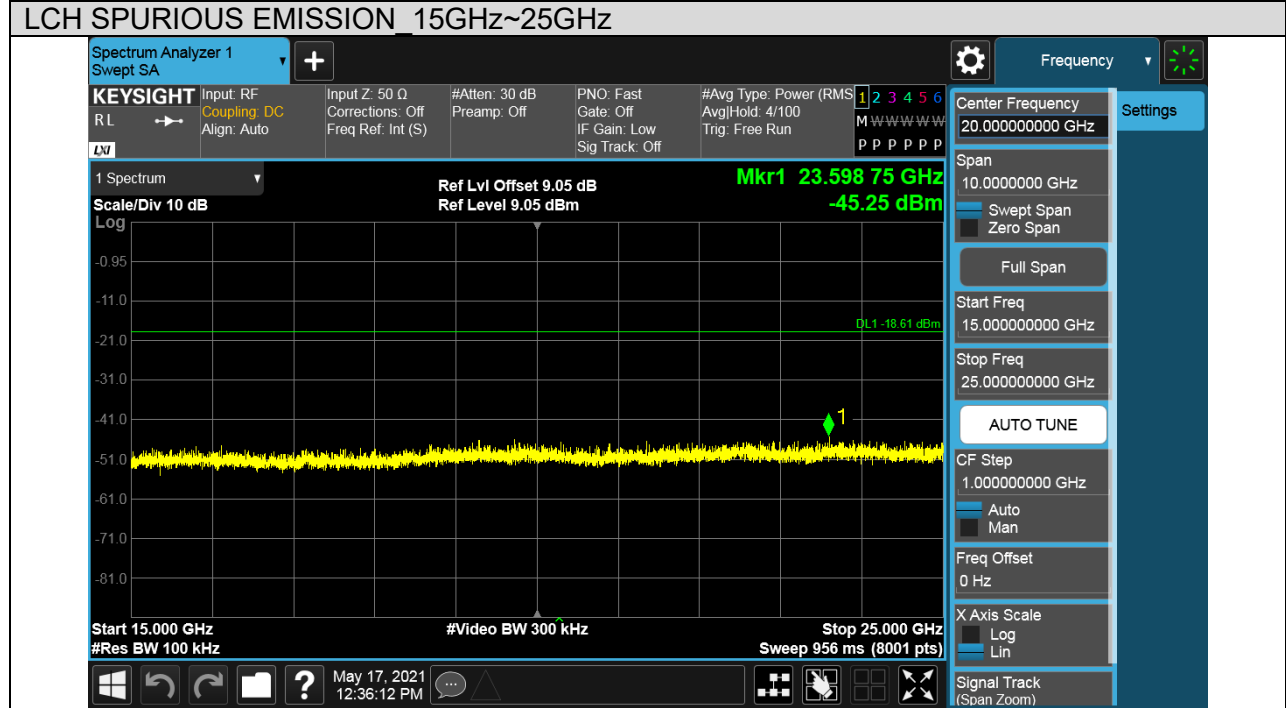



Test Mode	Channel	Verdict
BLE	MCH	PASS

Pref test Plot

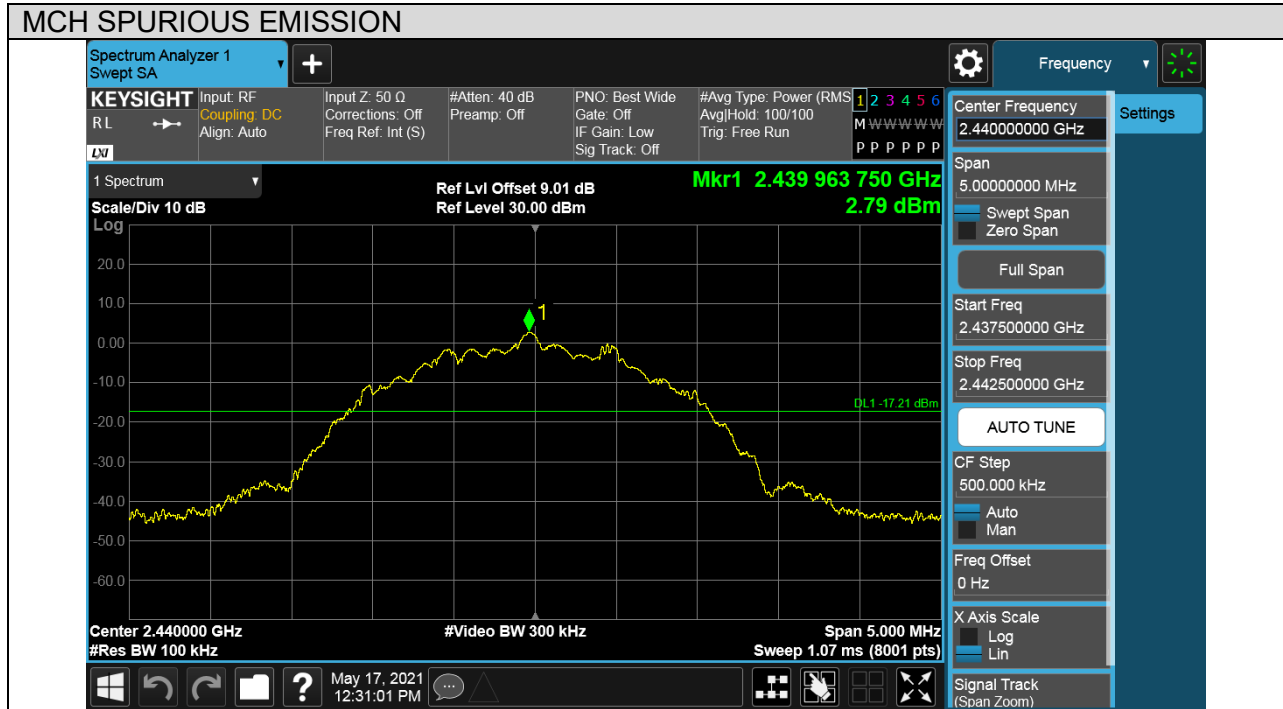



**FCC 47 CFR PART 15 SUBPART C  
ISED RSS-247 Issue 2**

**CERTIFICATION TEST REPORT**

*For*

**2.4GHz Wi-Fi/ Bluetooth module**

**MODEL NUMBER: ESP32-C3-WIZ2012**

**PROJECT NUMBER: 4789839465**

**REPORT NUMBER: 4789839465-1**

**FCC ID: 2AGBW-WIZ2012**

**IC: 20812-WIZ2012**

**ISSUE DATE: May. 19, 2021**

*Prepared for*

**Signify (China) Investment Co., Ltd**

*Prepared by*

**UL-CCIC COMPANY LIMITED**

**No. 2, Chengwan Road, Suzhou Industrial Park, People's Republic of China**

**Tel: + 86-512-6808 6400**

**Fax: + 86-512-6808 4099**

**Website: [www.ul.com](http://www.ul.com)**



Revision History

<u>Rev.</u>	<u>Issue Date</u>	<u>Revisions</u>	<u>Revised By</u>
V0	05/19/2021	Initial Issue	



## TABLE OF CONTENTS

<b>1. ATTESTATION OF TEST RESULTS .....</b>	<b>4</b>
<b>2. TEST METHODOLOGY .....</b>	<b>6</b>
<b>3. FACILITIES AND ACCREDITATION .....</b>	<b>6</b>
<b>4. CALIBRATION AND UNCERTAINTY .....</b>	<b>7</b>
4.1. <i>MEASURING INSTRUMENT CALIBRATION .....</i>	<i>7</i>
4.2. <i>MEASUREMENT UNCERTAINTY .....</i>	<i>7</i>
<b>5. EQUIPMENT UNDER TEST .....</b>	<b>8</b>
5.1. <i>DESCRIPTION OF EUT .....</i>	<i>8</i>
5.2. <i>MAXIMUM OUTPUT POWER.....</i>	<i>9</i>
5.3. <i>CHANNEL LIST .....</i>	<i>9</i>
5.4. <i>TEST CHANNEL CONFIGURATION.....</i>	<i>10</i>
5.5. <i>THE WORSE CASE POWER SETTING PARAMETER.....</i>	<i>10</i>
5.6. <i>DESCRIPTION OF AVAILABLE ANTENNAS .....</i>	<i>11</i>
5.7. <i>THE WORSE CASE CONFIGURATIONS .....</i>	<i>11</i>
5.8. <i>TEST ENVIRONMENT .....</i>	<i>12</i>
5.9. <i>DESCRIPTION OF TEST SETUP.....</i>	<i>13</i>
5.10. <i>MEASURING INSTRUMENT AND SOFTWARE USED .....</i>	<i>14</i>
<b>6. MEASUREMENT METHODS .....</b>	<b>15</b>
<b>7. ANTENNA PORT TEST RESULTS .....</b>	<b>16</b>
7.1. <i>ON TIME AND DUTY CYCLE.....</i>	<i>16</i>
7.2. <i>6 dB BANDWIDTH.....</i>	<i>19</i>
7.3. <i>CONDUCTED POWER.....</i>	<i>33</i>
7.4. <i>POWER SPECTRAL DENSITY .....</i>	<i>35</i>
7.5. <i>CONDUCTED BANDEDGE AND SPURIOUS EMISSIONS.....</i>	<i>46</i>
7.6. <i>RADIATED TEST RESULTS .....</i>	<i>93</i>
7.6.1. <i>LIMITS AND PROCEDURE .....</i>	<i>93</i>
7.6.2. <i>TEST ENVIRONMENT .....</i>	<i>99</i>
7.6.3. <i>RESTRICTED BANDEDGE .....</i>	<i>99</i>
7.6.4. <i>SPURIOUS EMISSIONS .....</i>	<i>128</i>
<b>8. AC POWER LINE CONDUCTED EMISSIONS.....</b>	<b>210</b>
<b>9. ANTENNA REQUIREMENTS.....</b>	<b>213</b>



## 1. ATTESTATION OF TEST RESULTS

### Applicant Information

Company Name: Signify (China) Investment Co., Ltd  
Address: #204, Block 2, 690 Bibo Road, Zhang Jiang High-Tech Park,  
Shanghai, China

### Manufacturer Information

Company Name: Signify (China) Investment Co., Ltd  
Address: #204, Block 2, 690 Bibo Road, Zhang Jiang High-Tech Park,  
Shanghai, China

### EUT Description

Product Name: 2.4GHz Wi-Fi/ Bluetooth module  
Model Name: ESP32-C3-WIZ2012  
Sample Number: 3686975  
Data of Receipt Sample: Mar. 08, 2021  
Date Tested: Mar. 09, 2021~ May. 18, 2021

APPLICABLE STANDARDS	
STANDARD	TEST RESULTS
CFR 47 Part 15 Subpart C	PASS
ISED RSS-247 Issue 2	PASS
ISED RSS-GEN Issue 5	PASS



Summary of Test Results			
Clause	Test Items	FCC Rules	Test Results
1	6db DTS Bandwidth and 99% Bandwidth	FCC 15.247 (a) (2) RSS-247 Clause 5.2 (a) RSS-Gen Clause 6.7	Complied
2	Conducted Power	FCC 15.247 (b) (3) RSS-247 Clause 5.4 (d) RSS-Gen Clause 6.12	Complied
3	Power Spectral Density	FCC 15.247 (e) RSS-247 Clause 5.2 (b)	Complied
4	Conducted Band edge And Spurious emission	FCC 15.247 (d) RSS-247 Clause 5.5 RSS-GEN Clause 6.13	Complied
5	Radiated Band edges and Spurious emission	FCC 15.247 (d) FCC 15.209 FCC 15.205 RSS-247 Clause 5.5 RSS-GEN Clause 8.9 RSS-GEN Clause 6.13	Complied
6	Conducted Emission Test For AC Power Port	FCC 15.207 RSS-GEN Clause 8.8	Complied
7	Antenna Requirement	FCC 15.203 RSS-GEN Clause 6.8	Complied
Remark: 1) The measurement result for the sample received is <Pass> according to < ANSI C63.10-2013, FCC CFR 47 Part 2, FCC CFR 47 Part 15C, ISED RSS-GEN, ISED RSS-247> when <Accuracy Method> decision rule is applied.			

Prepared By:

*Jason Yang*

Jason Yang  
Engineer

Reviewed By:

*Tom Tang*

Tom Tang  
Project Engineer

Authorized By:

*Chris Zhong*

Chris Zhong  
Laboratory Leader



## 2. TEST METHODOLOGY

The tests documented in this report were performed in accordance with FCC KDB 558074 D01 15.247 Meas Guidance v05r02, KDB 414788 D01 Radiated Test Site v01r01, ANSI C63.10-2013, FCC CFR 47 Part 2, FCC CFR 47 Part 15, ISED RSS-GEN ISSUE5, ISED RSS-247 ISSUE2.

## 3. FACILITIES AND ACCREDITATION

Accreditation Certificate	<p><b>A2LA (Certificate No.: 4829.01)</b>  <b>UL-CCIC COMPANY LIMITED has been assessed and proved to be in compliance with A2LA.</b></p> <p><b>FCC (FCC Designation No.: CN1247)</b>  <b>UL-CCIC COMPANY LIMITED has been recognized to perform compliance testing on equipment subject to the Commission's Declaration of Conformity (DoC) and Certification rules.</b></p> <p><b>IC (IC Designation No.: 25056)</b>  <b>UL-CCIC COMPANY LIMITED has been recognized to perform compliance testing on equipment subject to the Commission's Declaration of Conformity (DoC) and Certification rules.</b></p>
---------------------------	--

Note 1: All tests measurement facilities use to collect the measurement data are located at No. 2, Chengwan Road, Suzhou Industrial Park, Suzhou 215122, People's Republic of China

Note 2: For below 30MHz, lab had performed measurements at test anechoic chamber and comparing to measurements obtained on an open field site. These measurements below 30MHz had been correlated to measurements performed on an OFS.

Note 3: The test anechoic chamber in UL-CCIC COMPANY LIMITED had been calibrated and compared to the open field sites and the test anechoic chamber is shown to be equivalent to or worst case from the open field site.



## 4. CALIBRATION AND UNCERTAINTY

### 4.1. MEASURING INSTRUMENT CALIBRATION

The measuring equipment utilized to perform the tests documented in this report has been calibrated in accordance with the manufacturer's recommendations, and is traceable to recognized national standards.

### 4.2. MEASUREMENT UNCERTAINTY

Where relevant, the following measurement uncertainty levels have been estimated for tests performed on the apparatus:

Test Item	Uncertainty
Conduction emission	3.1dB
Radiation Emission test(include Fundamental emission) (9KHz-30MHz)	3.4dB
Radiation Emission test(include Fundamental emission) (30MHz-1GHz)	3.4dB
Radiation Emission test (1GHz to 26GHz)( include Fundamental emission)	3.9dB (1GHz-18Gz)
	4.2dB (18GHz-26.5Gz)
Note: This uncertainty represents an expanded uncertainty expressed at approximately the 95% confidence level using a coverage factor of k=2.	



## 5. EQUIPMENT UNDER TEST

### 5.1. DESCRIPTION OF EUT

Product Name:	2.4GHz Wi-Fi/ Bluetooth module
Model No.:	ESP32-C3-WIZ2012
Operating Frequency:	IEEE 802.11b/g/n(HT20): 2412MHz to 2462MHz IEEE 802.11n(HT40): 2422MHz to 2452MHz BT:2402 MHz to 2480MHz
	This report just for the WIFI part
Type of Modulation:	IEEE for 802.11b: DSSS (CCK, DQPSK, DBPSK) IEEE for 802.11g: OFDM (64QAM, 16QAM, QPSK, BPSK) IEEE for 802.11n (HT20 and HT40): OFDM (64QAM, 16QAM, QPSK, BPSK) BT:GFSK
Channels Step:	Channels with 5MHz step
Test software of EUT:	EspRFTestTool (manufacturer declare)
Antenna Type:	Ceramic antenna
Antenna Gain:	Antenna1: 5.19 dBi
	Remark: This data is provided by customer and our lab isn't responsible for this data



## 5.2. MAXIMUM OUTPUT POWER

Number of Transmit Chains (NTX)	IEE Std. 802.11	Channel Number	Max AV Conducted Power (dBm)
1	IEEE 802.11B SISO	1-11[11]	19.65
1	IEEE 802.11G SISO	1-11[11]	18.92
1	IEEE 802.11nHT20	1-11[11]	18.01
1	IEEE 802.11nHT40	3-9[7]	17.50

## 5.3. CHANNEL LIST

Channel List for 802.11b/g/n (20 MHz)							
Channel	Frequency (MHz)	Channel	Frequency (MHz)	Channel	Frequency (MHz)	Channel	Frequency (MHz)
1	2412	4	2427	7	2442	10	2457
2	2417	5	2432	8	2447	11	2462
3	2422	6	2437	9	2452		

Channel List for 802.11n (40 MHz)							
Channel	Frequency (MHz)	Channel	Frequency (MHz)	Channel	Frequency (MHz)	Channel	Frequency (MHz)
3	2422	5	2432	7	2442	9	2452
4	2427	6	2437	8	2447		



### 5.4. TEST CHANNEL CONFIGURATION

Test Mode	Test Channel	Frequency
WiFi TX(802.11b)	CH 1, CH 6, CH 11	2412MHz, 2437MHz, 2462MHz
WiFi TX(802.11g)	CH 1, CH3, CH 6, CH9, CH 11	2412MHz, 2422MHz*, 2437MHz, 2452MHz*, 2462MHz
WiFi TX(802.11n HT20)	CH 1, CH3, CH 6, CH9, CH 11	2412MHz, 2422MHz*, 2437MHz, 2452MHz*, 2462MHz
WiFi TX(802.11n HT40)	CH 3, CH5, CH 6, CH7,CH 9	2422MHz, 2432MHz*, 2437MHz, 2442MHz*, 2452MHz

Remark (\*) : Investigation have been performed for conducted power, power spectral density, conducted bandedge, conducted spurious emission and radiated emission test.

### 5.5. THE WORSE CASE POWER SETTING PARAMETER

The Worse Case Power Setting Parameter under 2400 ~ 2483.5MHz Band							
Test Software		EspRFtestTool					
Modulation Mode	Transmit Antenna Number	Test Channel					
		NCB: 20MHz			NCB: 40MHz		
		CH 1	CH 6	CH 11	CH 3	CH 6	CH 9
802.11b	1	0	0	0	/		
802.11g	1	12	0	12			
802.11n HT20	1	12	0	12			
802.11n HT40	1	/			12	0	12

Remark: The value list above are the setting of att in the software.

Additions testing setting:

The Worse Case Power Setting Parameter under 2400 ~ 2483.5MHz Band							
Test Software		EspRFtestTool					
Modulation Mode	Transmit Antenna Number	Test Channel					
		NCB: 20MHz			NCB: 40MHz		
		CH 3	CH 9	CH 5	CH 7		
802.11g	1	0	0	/			
802.11n HT20	1	0	0				
802.11n HT40	1	/			0	0	

Remark: The value list above are the setting of att in the software.



## 5.6. DESCRIPTION OF AVAILABLE ANTENNAS

Ant.	Frequency (MHz)	Antenna Type	Antenna Gain (dBi)
1	2400-2483.5	Ceramic antenna	5.19

Test Mode	Transmit and Receive Mode	Description
IEEE 802.11b	<input checked="" type="checkbox"/> 1TX, 1RX	Antenna1 can be used as transmitting/receiving antenna independently.
IEEE 802.11g	<input checked="" type="checkbox"/> 1TX, 1RX	Antenna1 can be used as transmitting/receiving antenna independently.
IEEE 802.11N (HT20)	<input checked="" type="checkbox"/> 1TX, 1RX	Antenna1 can be used as transmitting/receiving antenna independently.
IEEE 802.11N (HT20)	<input checked="" type="checkbox"/> 1TX, 1RX	Antenna1 can be used as transmitting/receiving antenna independently.

## 5.7. THE WORSE CASE CONFIGURATIONS

For the product, there two transmission antennas, and pre-testing both of them, only the worse data for the antenna is recorded in the report.

Worst-case data rates as provided by the client were:

802.11b mode: 1 Mbps  
802.11b mode: 6 Mbps  
802.11n HT20 mode: MCS0  
802.11n HT40 mode: MCS0



### 5.8. TEST ENVIRONMENT

Environment Parameter	Selected Values During Tests	
Relative Humidity	55 ~ 65%	
Atmospheric Pressure:	1025Pa	
Temperature	TN	23 ~ 28°C
Voltage :	VL	N/A
	VN	AC 120V
	VH	N/A

Note: VL= Lower Extreme Test Voltage  
VN= Nominal Voltage  
VH= Upper Extreme Test Voltage  
TN= Normal Temperature

## 5.9. DESCRIPTION OF TEST SETUP

### SUPPORT EQUIPMENT

Item	Equipment	Brand Name	Model Name	Description
1	Laptop	ThinkPad	E550c	N/A
2	Fixed Frequency Board	N/A	N/A	Supply by Customer
3	AC adapter	AC/DA ADAPTER	N/A	INPUT:100-240V~50/60Hz OUTPUT:5V  1A (Supply by UL Lab)

### I/O PORT

Cable No	Port	Connector Type	Cable Type	Cable Length(m)	Remarks
1	N/A	N/A	N/A	N/A	N/A

### ACCESSORY

Item	Accessory	Brand Name	Model Name	Description
1	USB Cable	NA	NA	100cm Length (Supply by UL Lab)

### TEST SETUP

The EUT can work in an engineer mode with a software through a table PC.

### SETUP DIAGRAM FOR TESTS

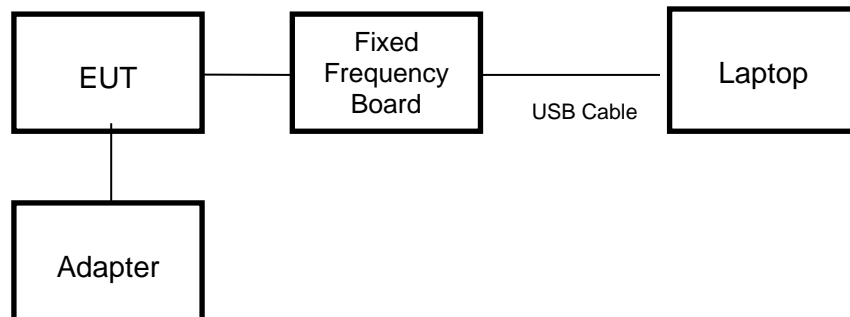



### 5.10. MEASURING INSTRUMENT AND SOFTWARE USED

Conducted Emissions (Instrument)							
Used	Equipment	Manufacturer	Model No.	Serial No.	Upper Last Cal.	Last Cal.	Next Cal.
<input checked="" type="checkbox"/>	EMI Test Receiver	R&S	ESR3	126700	2019-12-12	2020-12-05	2021-12-04
<input checked="" type="checkbox"/>	Two-Line V-Network	R&S	ENV216	126701	2019-12-12	2020-12-05	2021-12-04
<input checked="" type="checkbox"/>	Artificial Mains Networks	R&S	ENY81	126711	2019-12-12	2020-12-05	2021-12-04
Software							
Used	Description		Manufacturer	Name	Version		
<input checked="" type="checkbox"/>	Test Software for Conducted disturbance		R&S	EMC32	Ver. 9.25		
Radiated Emissions (Instrument)							
Used	Equipment	Manufacturer	Model No.	Serial No.	Upper Last Cal.	Last Cal.	Next Cal.
<input checked="" type="checkbox"/>	Spectrum Analyzer	Keysight	N9010B	MY57110128	2020-05-10	2021-05-09	2022-05-08
<input checked="" type="checkbox"/>	EMI test receiver	R&S	ESR26	1267603	2019-12-12	2020-12-05	2021-12-04
<input checked="" type="checkbox"/>	Receiver Antenna (9kHz-30MHz)	Schwarzbeck	FMZB 1513	513-265	N/A	2018-06-15	2021-06-14
<input checked="" type="checkbox"/>	Receiver Antenna (30MHz-1GHz)	SunAR RF Motion	JB1	177821	N/A	2019-01-28	2022-01-27
<input checked="" type="checkbox"/>	Receiver Antenna (1GHz-18GHz)	R&S	HF907	126705	2018-01-29	2019-01-28	2022-01-27
<input checked="" type="checkbox"/>	Receiver Antenna (18GHz-26.5GHz)	Schwarzbeck	BBHA9170	126706	2019-02-06	2020-12-05	2021-12-04
<input checked="" type="checkbox"/>	Pre-amplification (To 18GHz)	Compliance Direction System Inc.	PAP-1G18-50	14140-13467	2019-03-18	2020-12-05	2021-12-04
<input checked="" type="checkbox"/>	Pre-amplification (To 26.5GHz)	R&S	SCU-26D	134668	2019-02-06	2020-09-27	2021-09-26
<input checked="" type="checkbox"/>	Band Reject Filter	Wainwright	WRCJV8-2350-2400-2483.5-2533.5-40SS	1	2020-05-10	2021-05-09	2022-05-08
<input checked="" type="checkbox"/>	Highpass Filter	Wainwright	WHKX10-2700-3000-18000-40SS	2	2020-05-10	2021-05-09	2022-05-08
Software							
Used	Description		Manufacturer	Name	Version		
<input checked="" type="checkbox"/>	Test Software for Radiated disturbance		Tonscend	JS32	V1.0		
Other instruments							
Used	Equipment	Manufacturer	Model No.	Serial No.	Upper Last Cal.	Last Cal.	Next Cal.
<input checked="" type="checkbox"/>	Spectrum Analyzer	Keysight	N9010B	MY57110128	2020-05-10	2021-05-09	2022-05-08
<input checked="" type="checkbox"/>	Power Meter	Keysight	U2021XA	MY57110002	2020-05-10	2021-05-09	2022-05-08



## 6. MEASUREMENT METHODS

No.	Test Item	KDB Name	Section
1	6dB Bandwidth and 99% Bandwidth	KDB 558074 D01 15.247 Meas Guidance v05r02	8.2
2	Conducted Output Power	KDB 558074 D01 15.247 Meas Guidance v05r02	8.3.1.3/8.3.2.3
3	Power Spectral Density	KDB 558074 D01 15.247 Meas Guidance v05r02	8.4
4	Out-of-band emissions in non-restricted bands	KDB 558074 D01 15.247 Meas Guidance v05r02	8.5
5	Out-of-band emissions in restricted bands	KDB 558074 D01 15.247 Meas Guidance v05r02	8.6
6	Band-edge	KDB 558074 D01 15.247 Meas Guidance v05r02	8.7
7	Conducted Emission Test For AC Power Port	ANSI C63.10-2013	6.2



## 7. ANTENNA PORT TEST RESULTS

### 7.1. ON TIME AND DUTY CYCLE

#### LIMITS

None; for reporting purposes only

#### PROCEDURE

FCC KDB 558074 Zero-Span Spectrum Analyzer Method

#### TEST SETUP

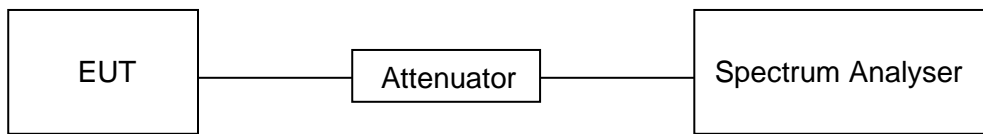

#### TEST ENVIRONMENT

Temperature	22°C	Relative Humidity	56%
Atmosphere Pressure	101kPa	Test Voltage	AC 120V

#### RESULTS

Mode	On Time (msec)	Period (msec)	Duty Cycle x (Linear)	Duty Cycle (%)	Duty Cycle Correction Factor (db)	1/T Minimum VBW (KHz)	Final Minimum VBW (KHz)
11B	32.93	32.98	0.998	99.8	0.009	0.03	1
11G	5.465	5.514	0.991	99.1	0.039	0.18	1
11N HT20	5.051	5.113	0.988	98.8	0.052	0.20	1
11N HT40	2.431	2.495	0.974	97.4	0.114	0.41	1

Note: 1) Duty Cycle Correction Factor=10log(1/x).  
 2) Where: x is Duty Cycle(Linear)  
 3) Where: T is On Time (transmit duration)



### 11B ON TIME AND DUTY CYCLE MID CH (WORSE CASE)

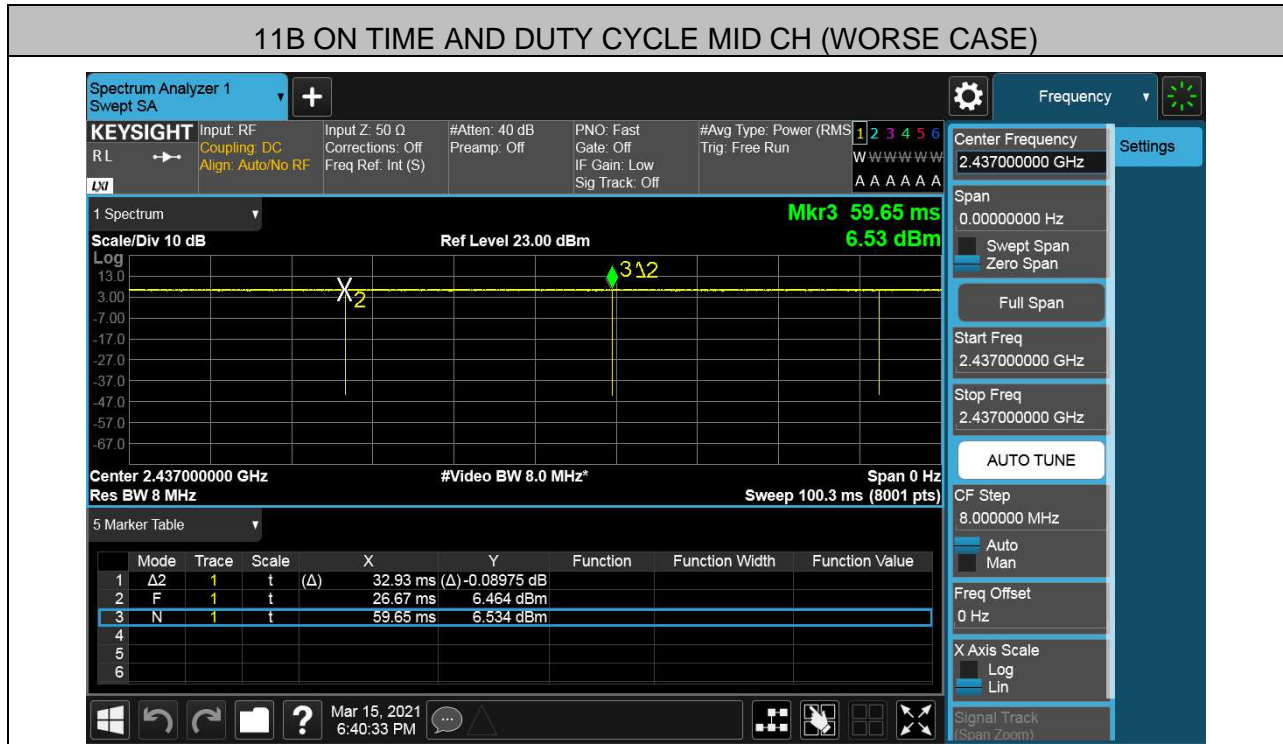

### 11G ON TIME AND DUTY CYCLE MID CH (WORSE CASE)

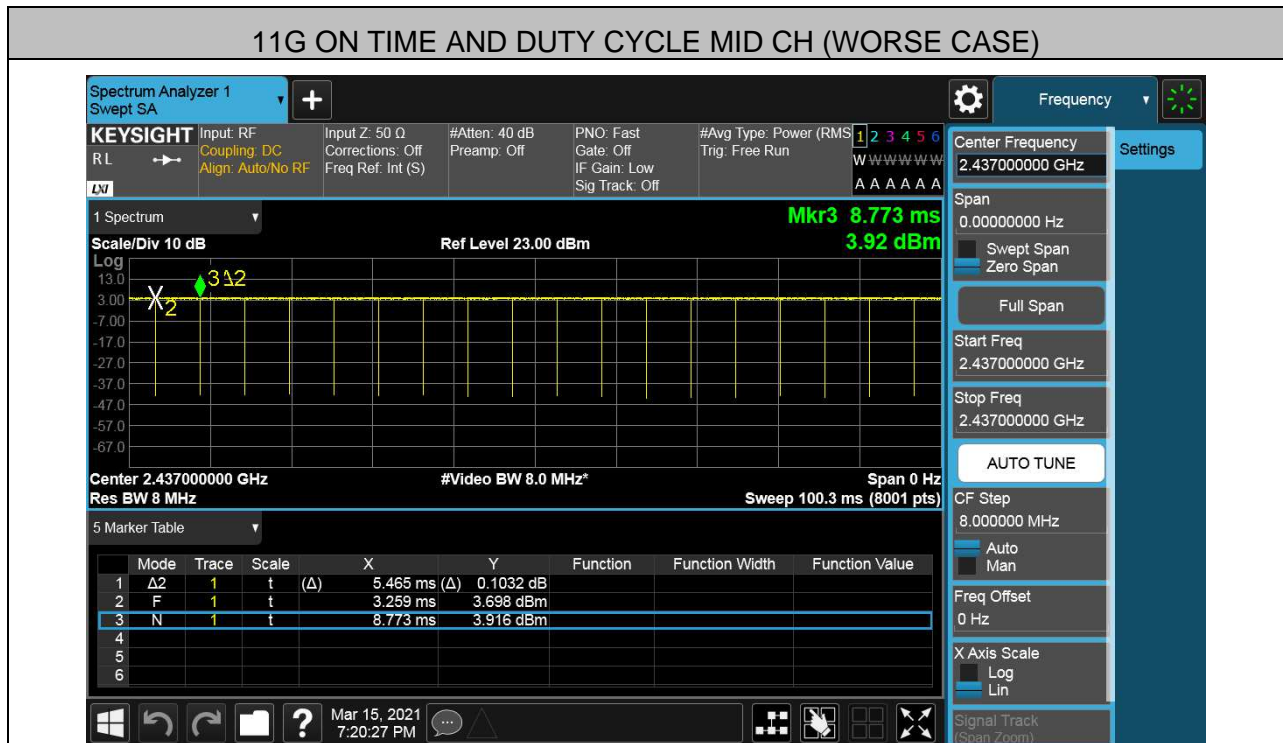



### 11N HT20 ON TIME AND DUTY CYCLE MID CH (WORSE CASE)

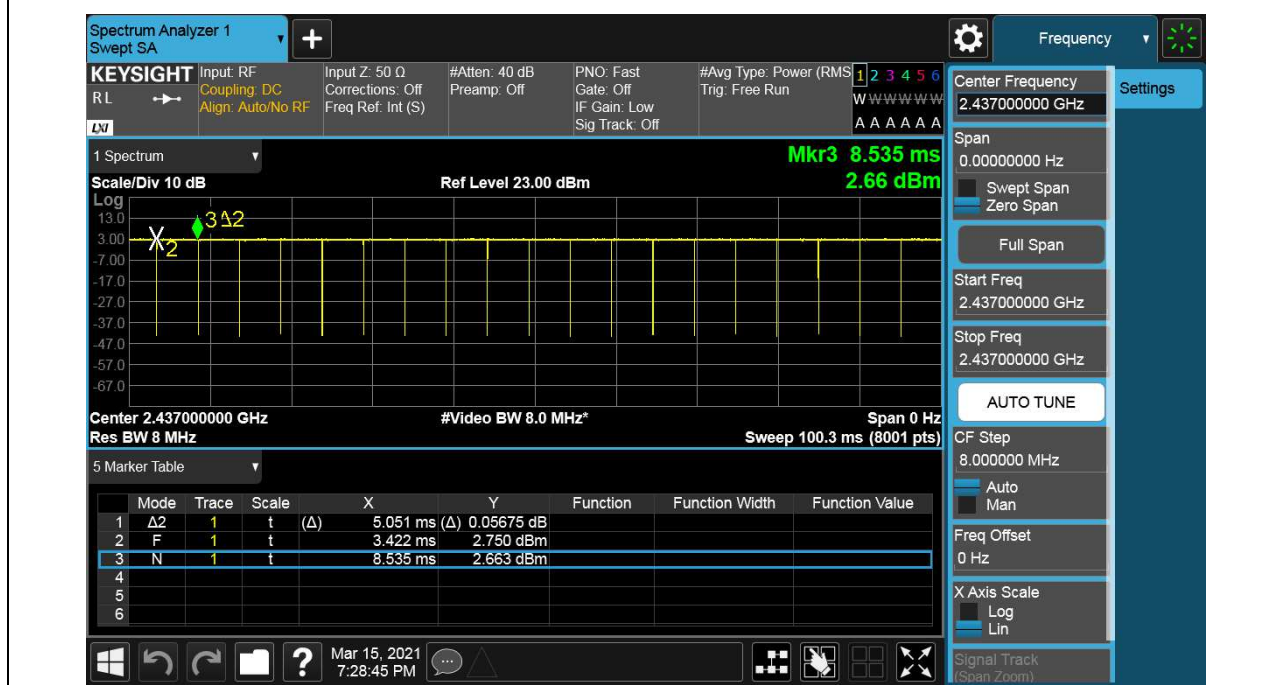

### 11N HT40 ON TIME AND DUTY CYCLE MID CH (WORSE CASE)

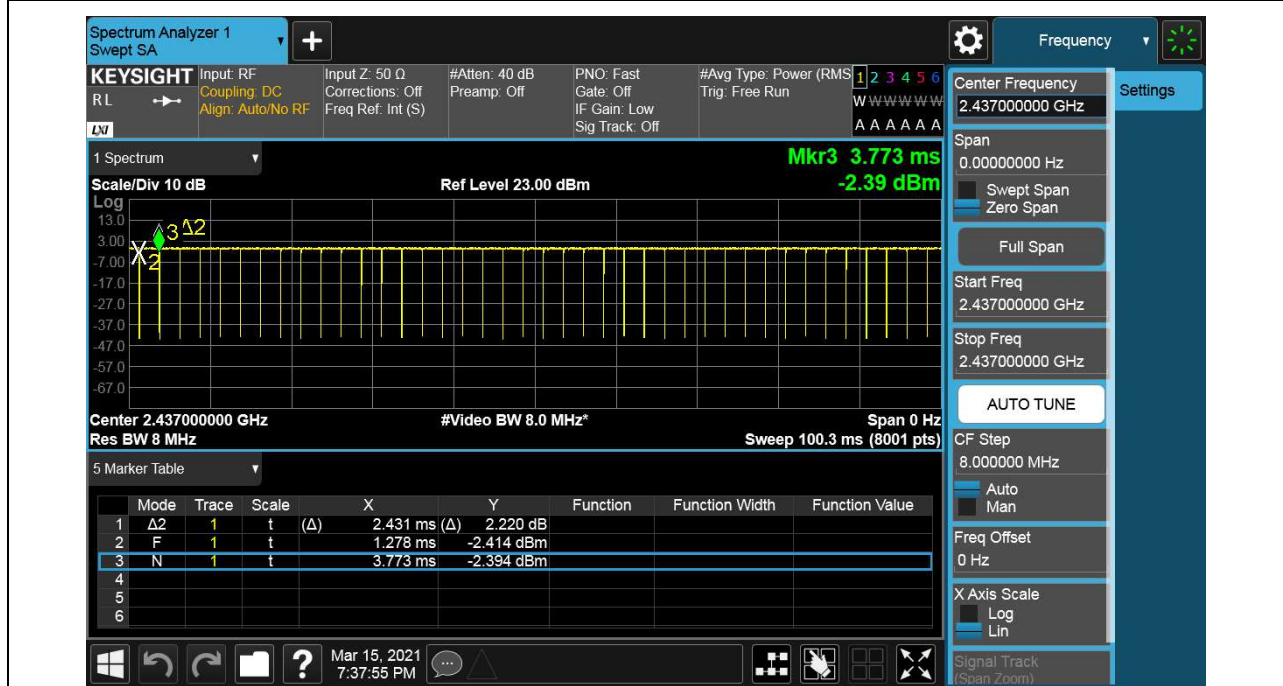

## 7.2. 6 dB BANDWIDTH

### LIMITS

FCC Part15 (15.247) Subpart C, ISED RSS-247 Issue 2			
Section	Test Item	Limit	Frequency Range (MHz)
FCC 15.247(a)(2)	6dB Bandwidth	$\geq 500\text{KHz}$	2400-2483.5
ISED RSS-Gen Clause 6.7	99% Occupied Bandwidth	For reporting purposes only.	2400-2483.5

### TEST PROCEDURE

Refer to FCC KDB 558074, connect the UUT to the spectrum analyzer and use the following settings:

Center Frequency	The centre frequency of the channel under test
Detector	Peak
RBW	For 6dB Bandwidth :100K For 99% Occupied Bandwidth :1% to 5% of the occupied bandwidth
VBW	For 6dB Bandwidth : $\geq 3 \times \text{RBW}$ For 99% Occupied Bandwidth : approximately $3 \times \text{RBW}$
Trace	Max hold
Sweep	Auto couple

Allow the trace to stabilize and measure the maximum width of the emission that is constrained by the frequencies associated with the two outermost amplitude points (upper and lower frequencies) that are attenuated by 6 dB relative to the maximum level measured in the fundamental emission.

### TEST SETUP

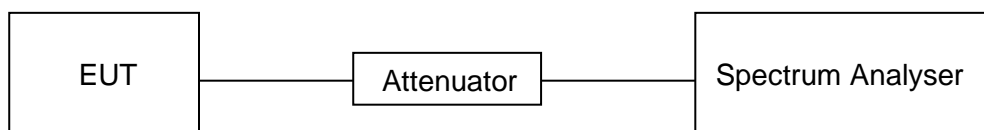



**RESULTS**

Test Mode	Test Channel	6dB bandwidth (MHz)	99% bandwidth (MHz)	Result
11B	LCH	9.078	13.010	Pass
	MCH	9.072	13.003	Pass
	HCH	9.052	13.009	Pass
11G	LCH	16.38	16.826	Pass
	MCH	16.34	16.790	Pass
	HCH	16.35	16.906	Pass
11N HT20	LCH	17.60	17.960	Pass
	MCH	17.60	17.932	Pass
	HCH	17.62	17.949	Pass
11N HT40	LCH	34.98	35.400	Pass
	MCH	33.87	35.339	Pass
	HCH	34.05	35.302	Pass



**Test Graphs**  
**For 6dB Bandwidth part:**

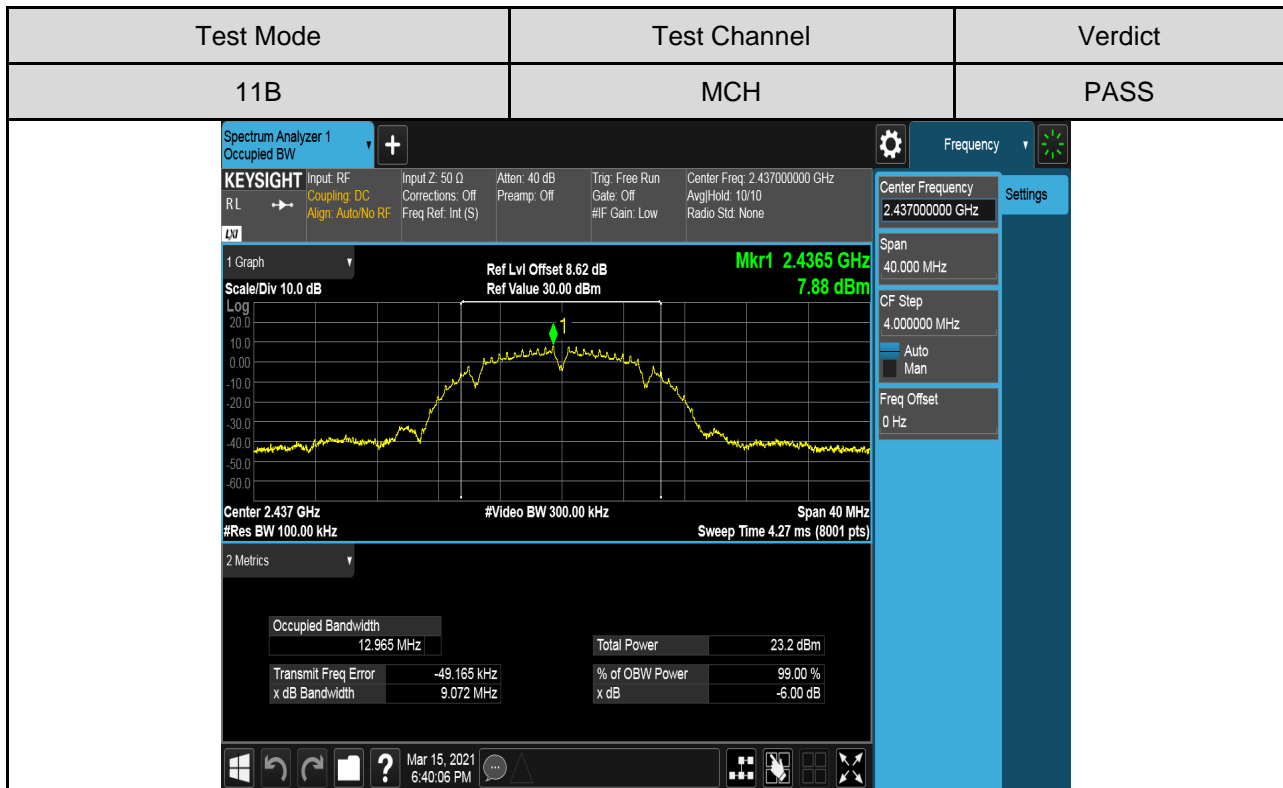
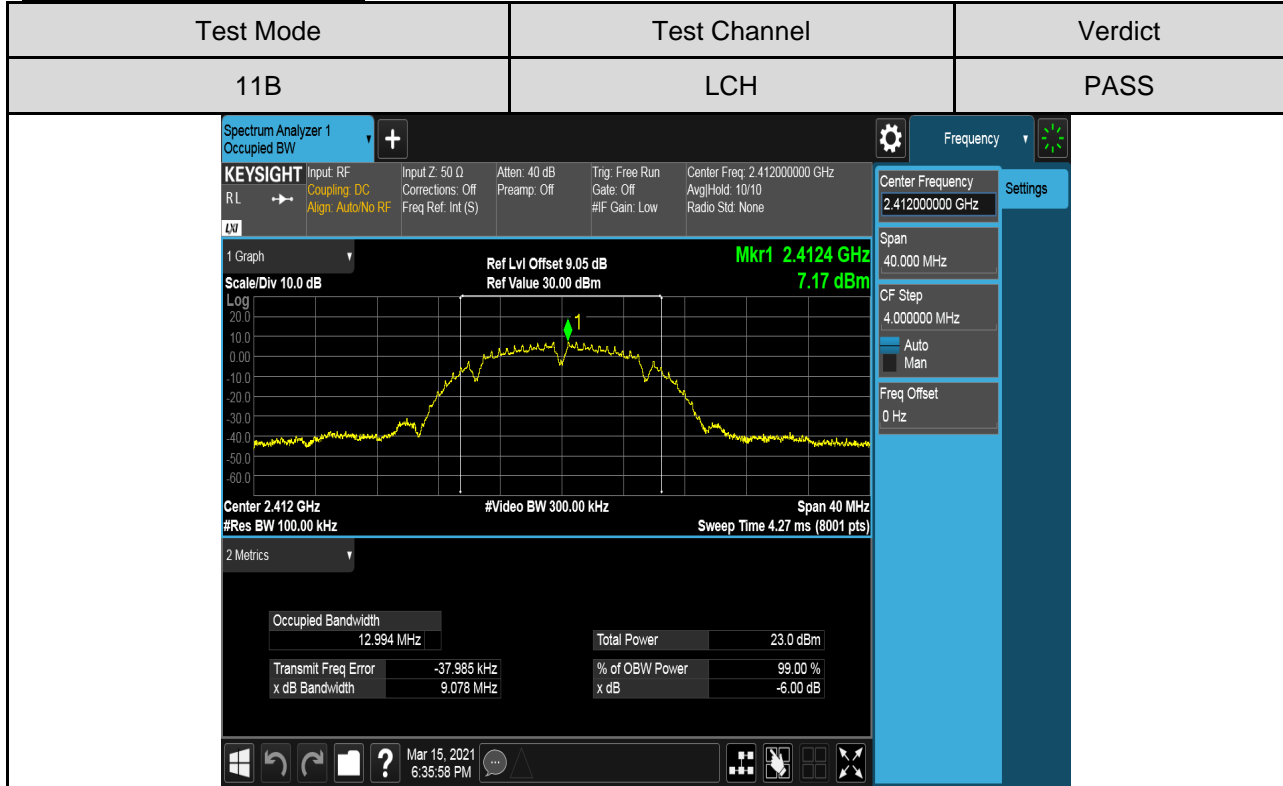

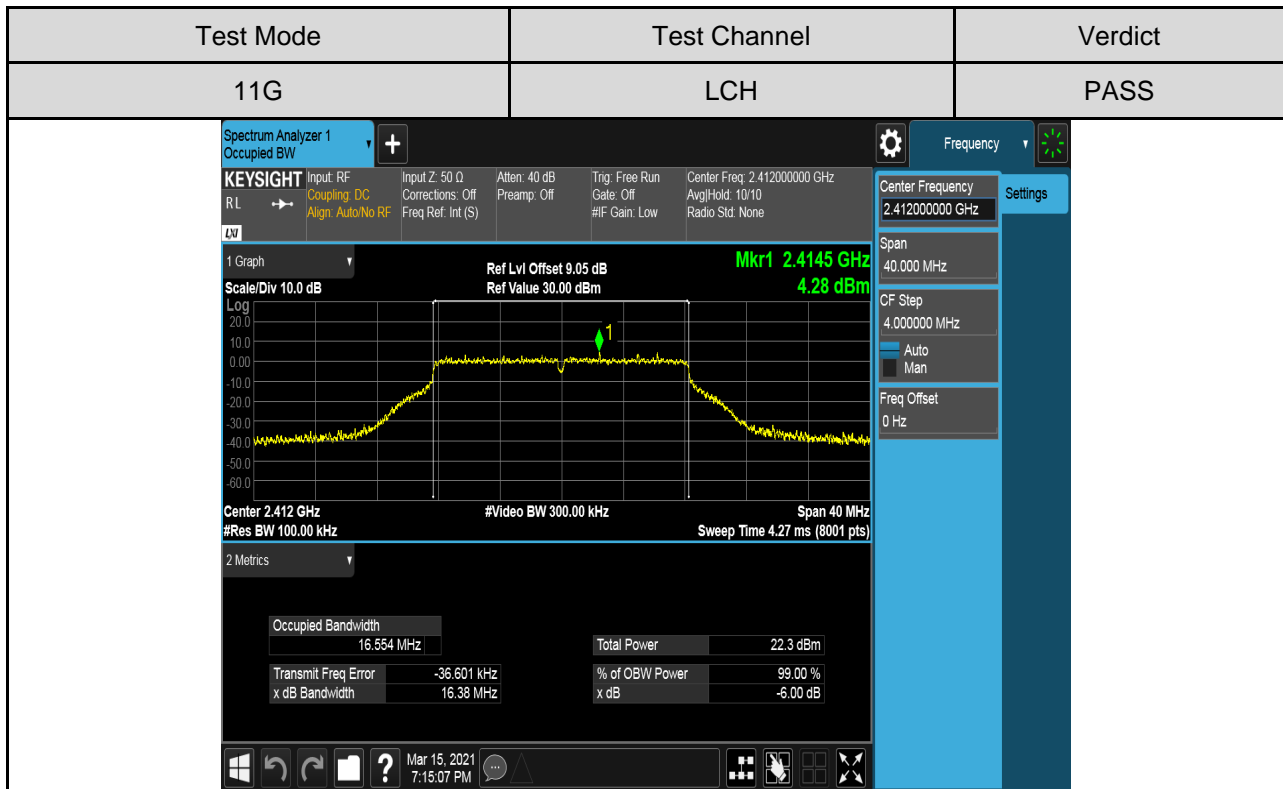
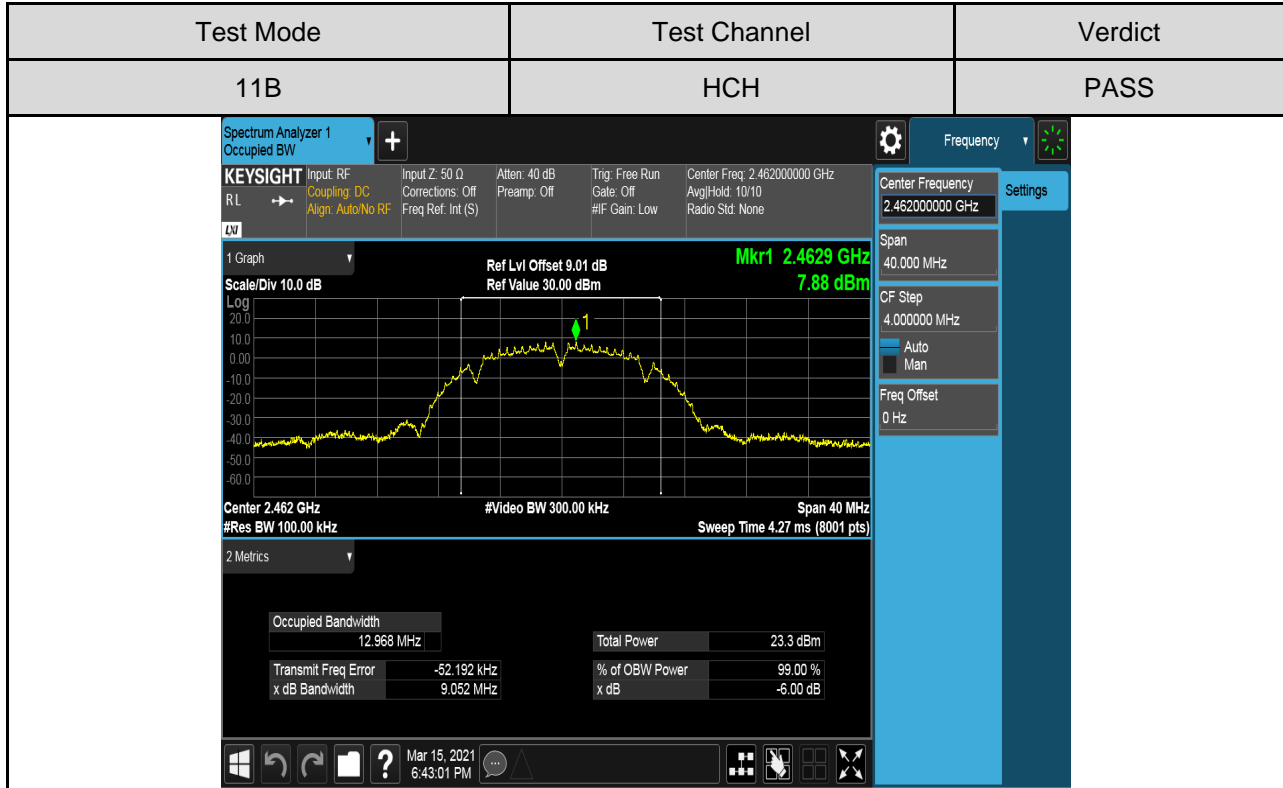

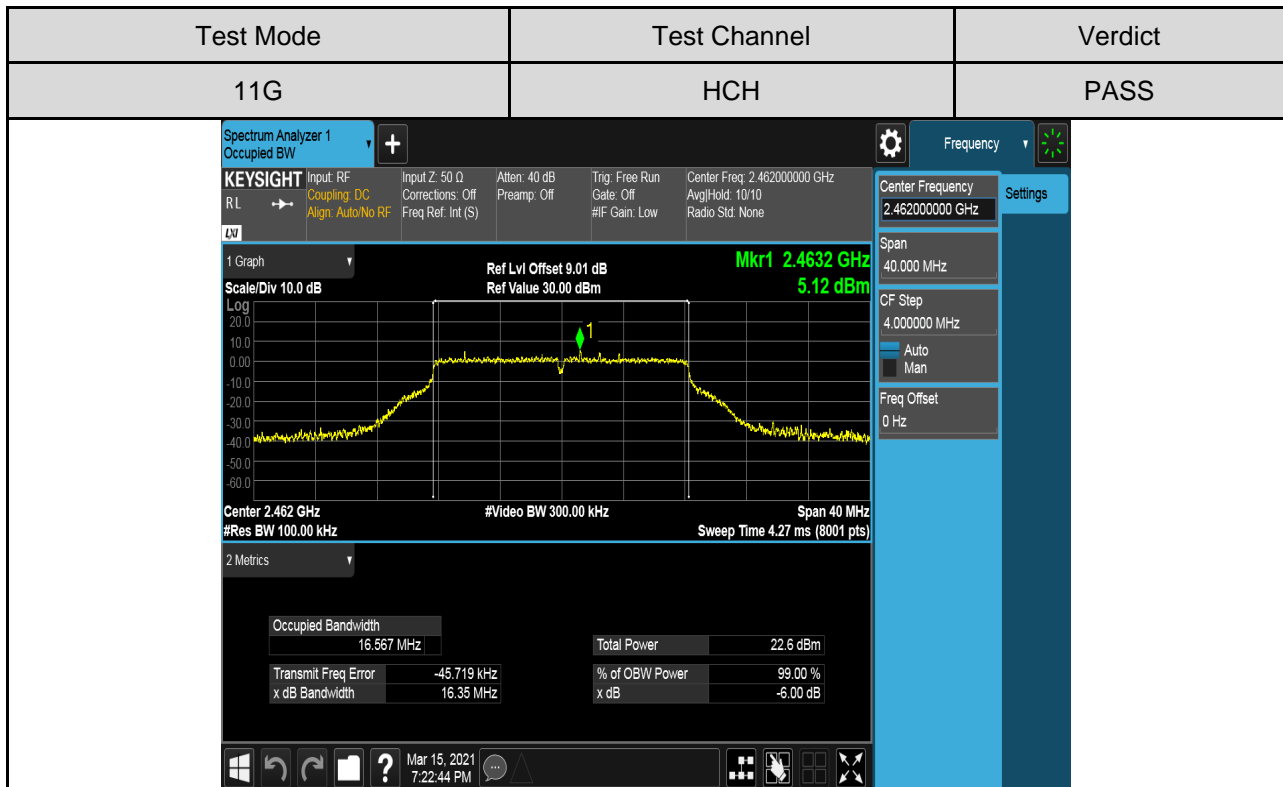
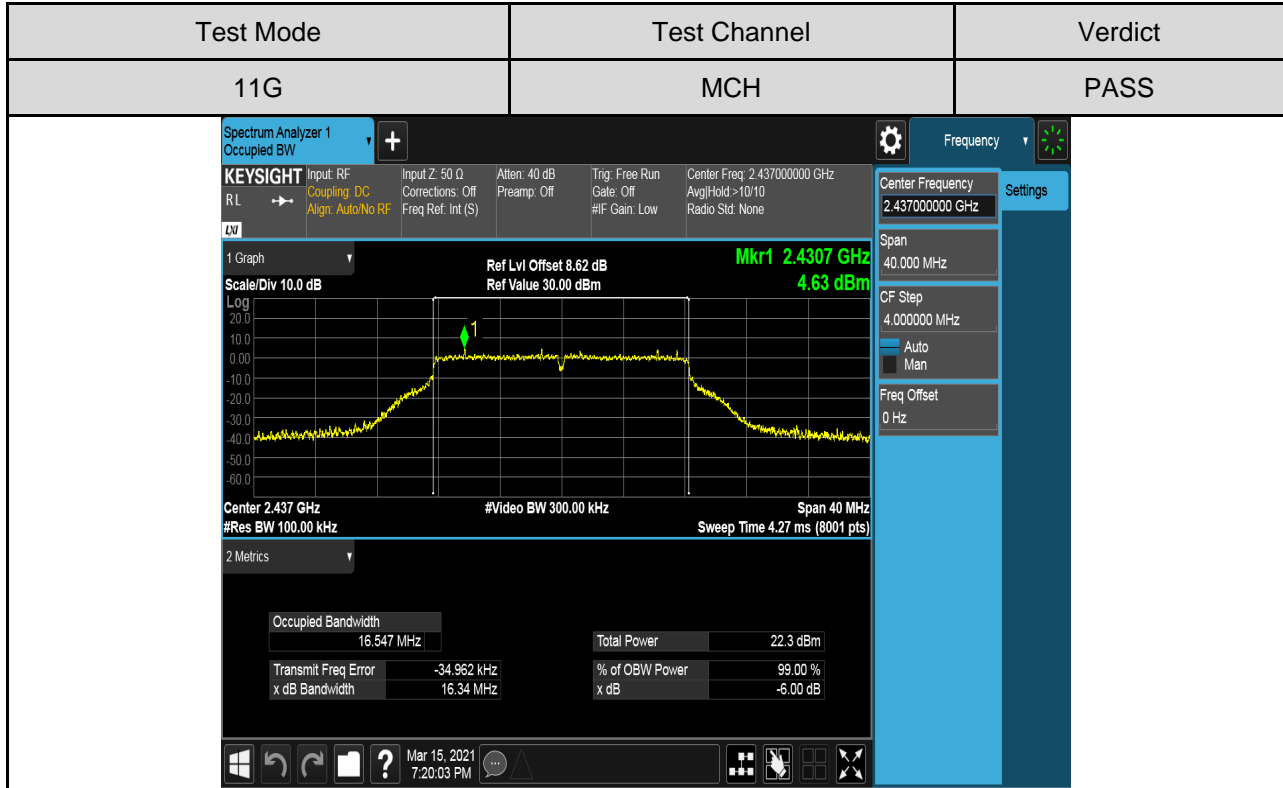

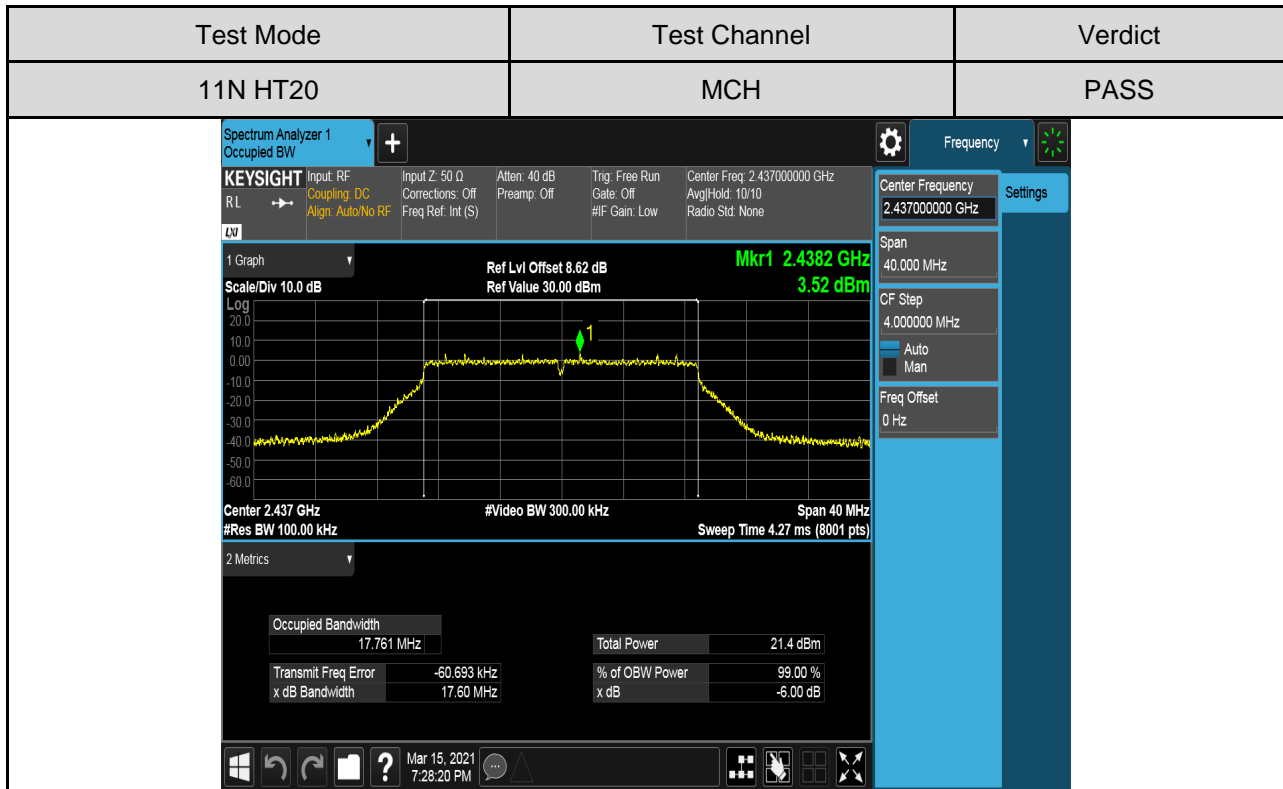
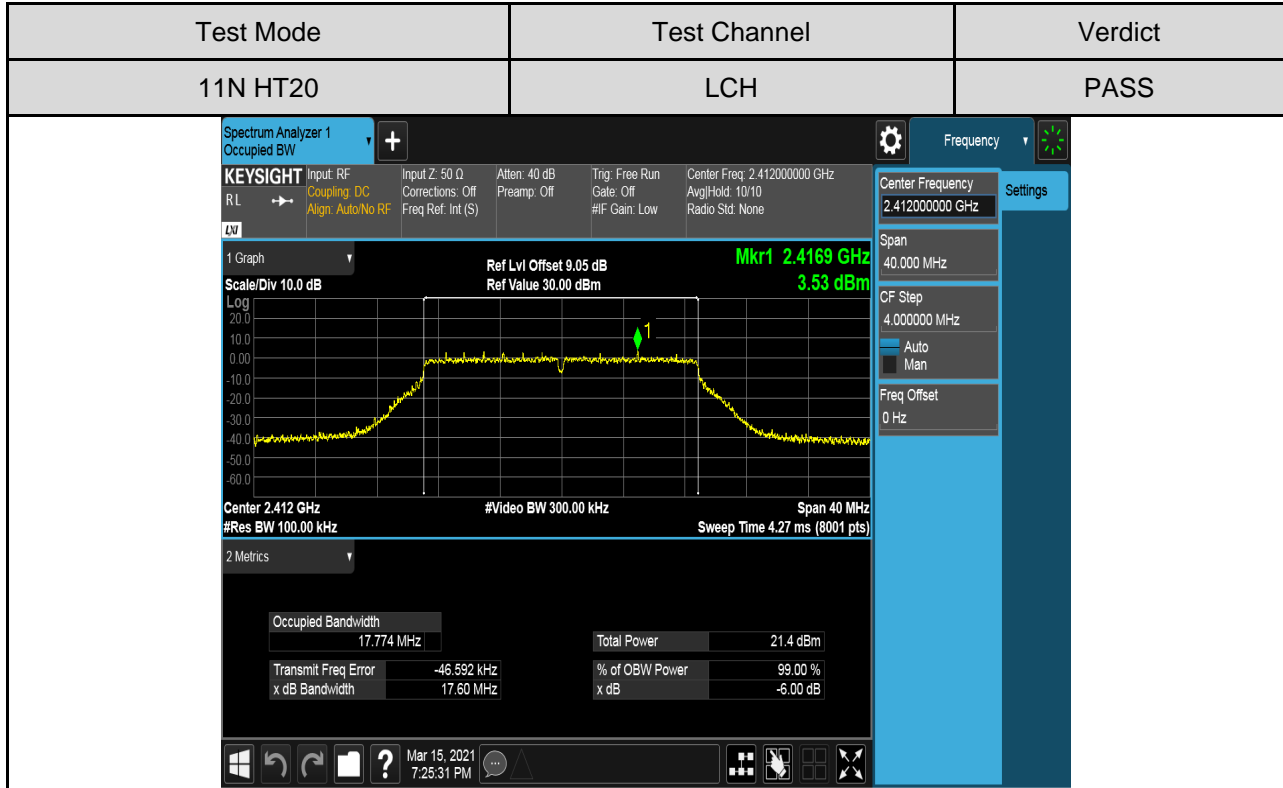

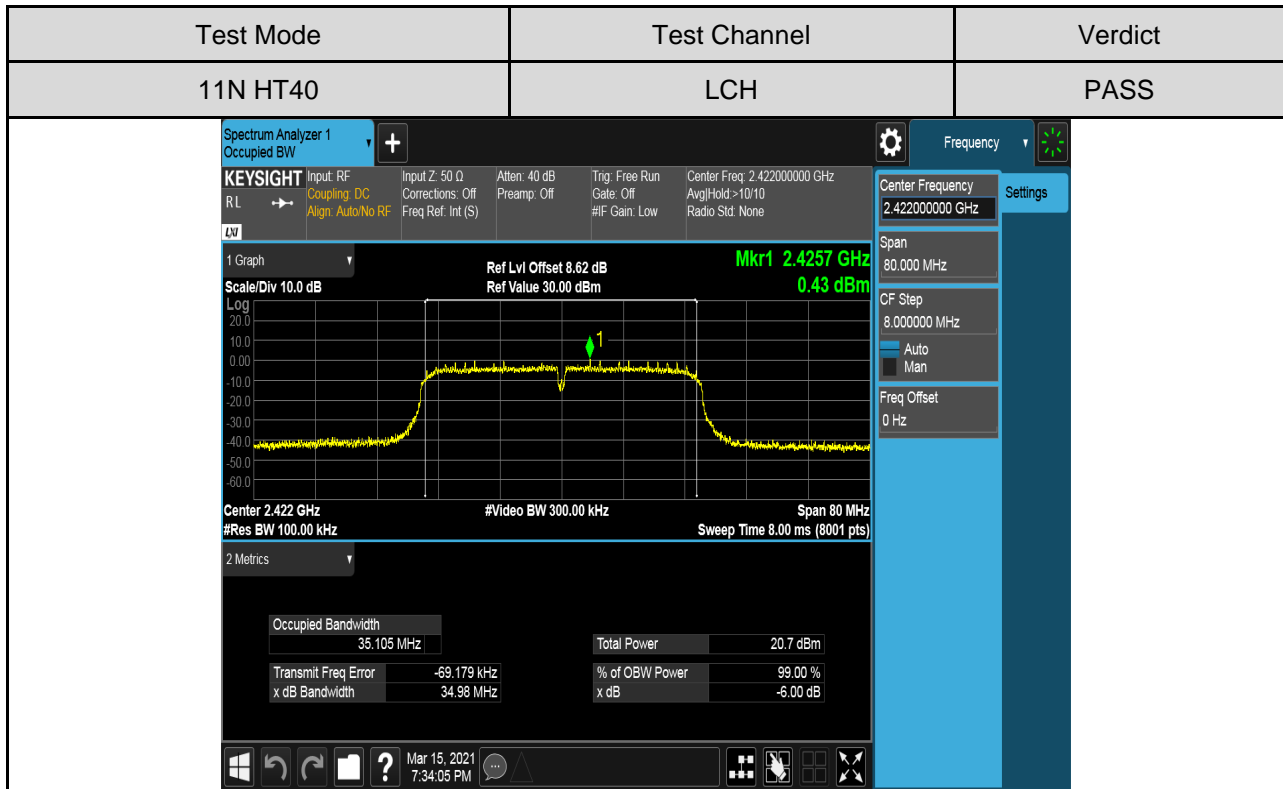
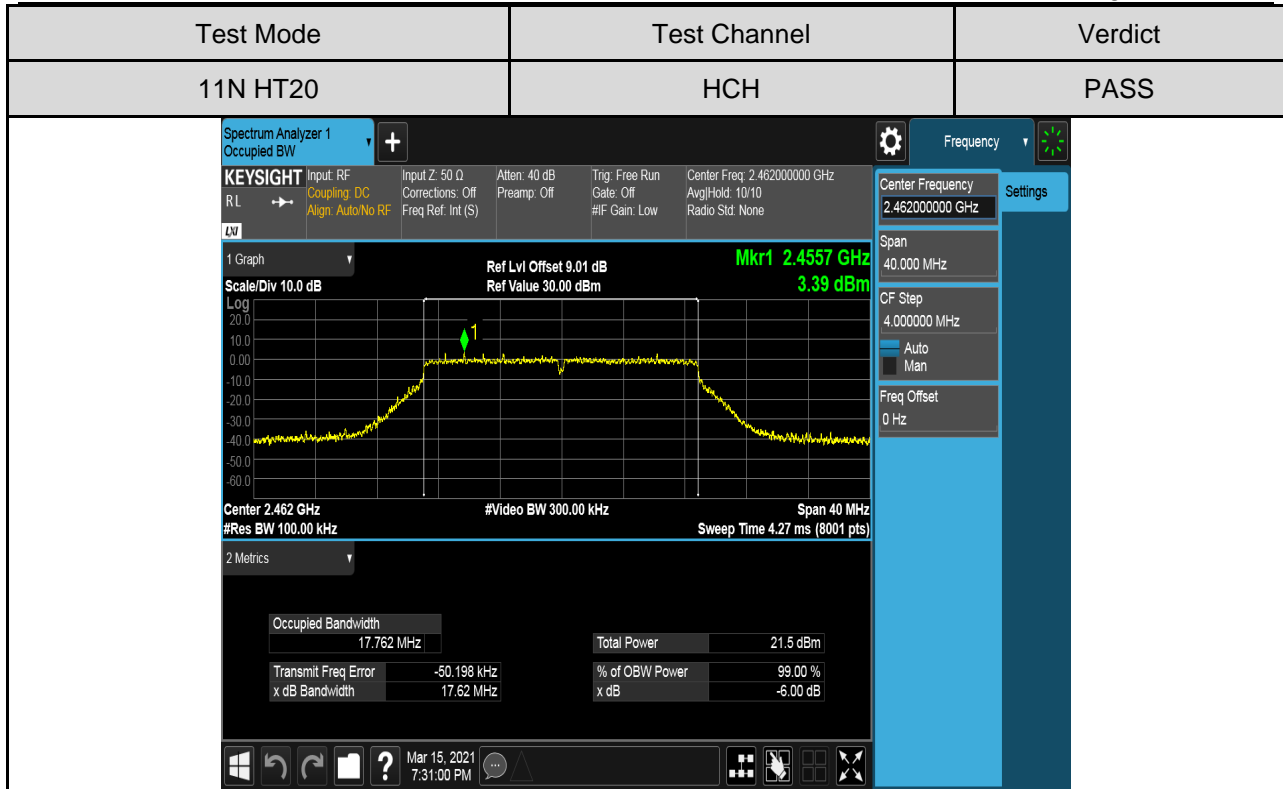

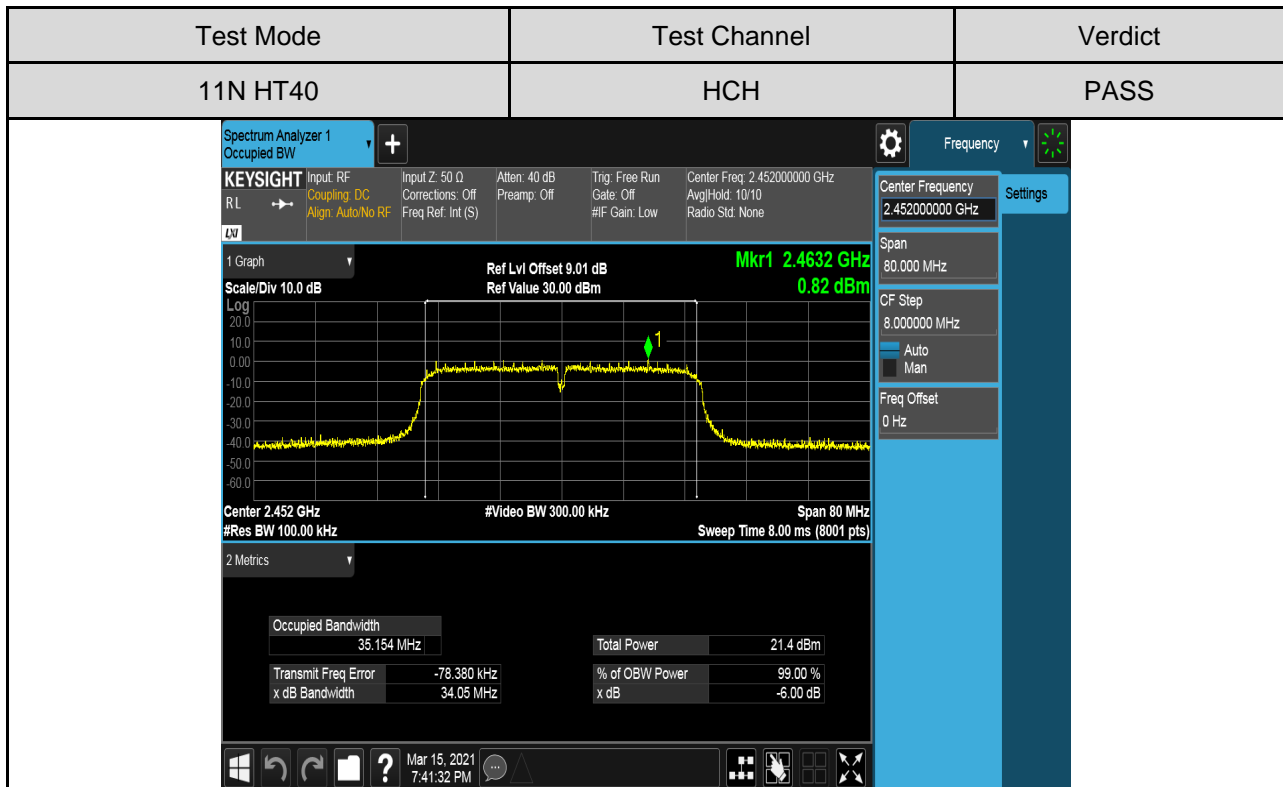
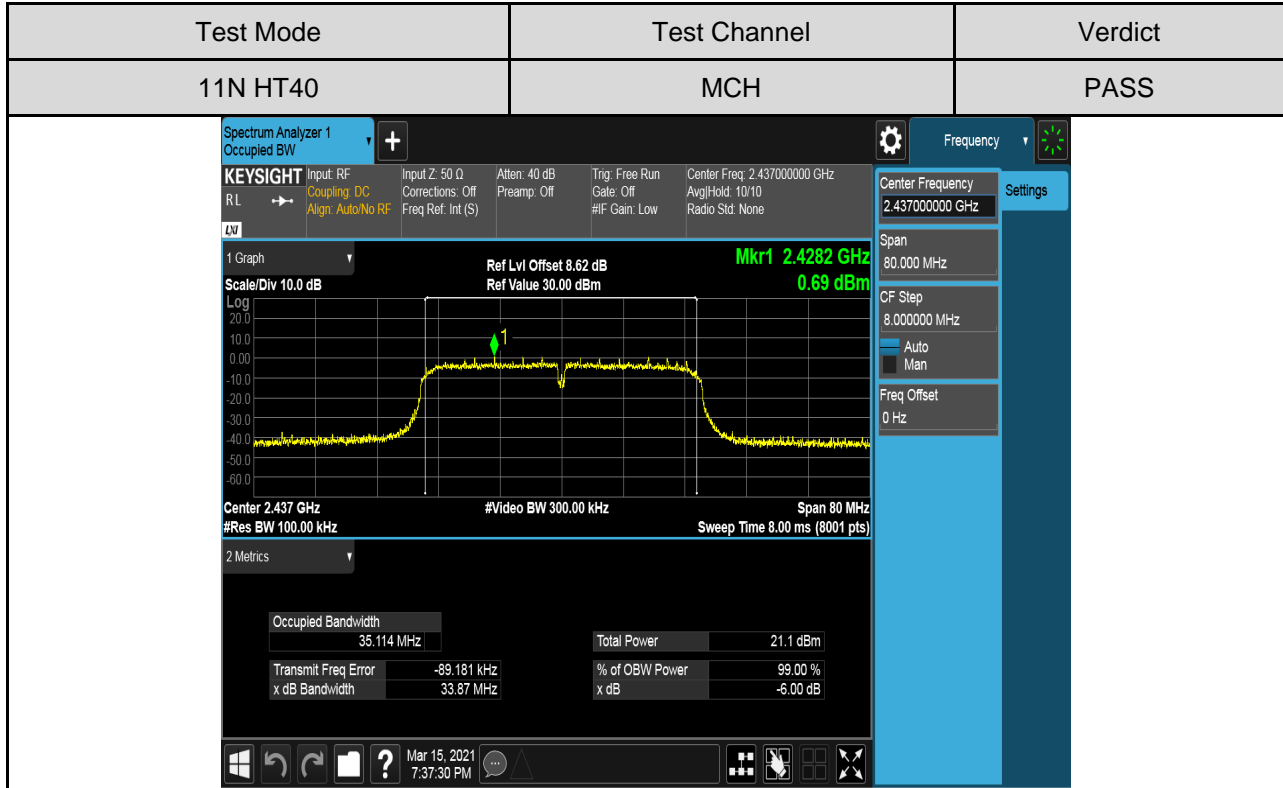



**For 99% Bandwidth part:**

Test Mode	Test Channel	Verdict												
11B	LCH	PASS												
<p><b>Spectrum Analyzer 1</b> Occupied BW</p> <p><b>KEYSIGHT</b> Input: RF Input Z: 50 Ω Atten: 40 dB Trig: Free Run Center Freq: 2.412000000 GHz      R.L. → Coupling: DC Corrections: Off Freq Ref: Int (S) Preamp: Off Gate: Off Avg/Hold: 10/10      Align: Auto/No RF #IF Gain: Low Radio Std: None</p> <p>1 Graph Scale/Div 10.0 dB Log Ref Lvl Offset 9.05 dB Ref Value 30.00 dBm</p> <p>Center 2.412 GHz #Video BW 620.00 kHz Span 40 MHz      #Res BW 200.00 kHz Sweep Time 1.07 ms (8001 pts)</p> <p>2 Metrics</p> <table border="1"> <tr> <td>Occupied Bandwidth</td> <td>13.010 MHz</td> <td>Total Power</td> <td>21.5 dBm</td> </tr> <tr> <td>Transmit Freq Error</td> <td>-23.747 kHz</td> <td>% of OBW Power</td> <td>99.00 %</td> </tr> <tr> <td>x dB Bandwidth</td> <td>9.170 MHz</td> <td>x dB</td> <td>-6.00 dB</td> </tr> </table> <p>Mar 15, 2021 6:36:11 PM</p>			Occupied Bandwidth	13.010 MHz	Total Power	21.5 dBm	Transmit Freq Error	-23.747 kHz	% of OBW Power	99.00 %	x dB Bandwidth	9.170 MHz	x dB	-6.00 dB
Occupied Bandwidth	13.010 MHz	Total Power	21.5 dBm											
Transmit Freq Error	-23.747 kHz	% of OBW Power	99.00 %											
x dB Bandwidth	9.170 MHz	x dB	-6.00 dB											

Test Mode	Test Channel	Verdict												
11B	MCH	PASS												
<p><b>Spectrum Analyzer 1</b> Occupied BW</p> <p><b>KEYSIGHT</b> Input: RF Input Z: 50 Ω Atten: 40 dB Trig: Free Run Center Freq: 2.437000000 GHz      R.L. → Coupling: DC Corrections: Off Freq Ref: Int (S) Preamp: Off Gate: Off Avg/Hold: &gt;10/10      Align: Auto/No RF #IF Gain: Low Radio Std: None</p> <p>1 Graph Scale/Div 10.0 dB Log Ref Lvl Offset 8.62 dB Ref Value 30.00 dBm</p> <p>Center 2.437 GHz #Video BW 620.00 kHz Span 40 MHz      #Res BW 200.00 kHz Sweep Time 1.07 ms (8001 pts)</p> <p>2 Metrics</p> <table border="1"> <tr> <td>Occupied Bandwidth</td> <td>13.003 MHz</td> <td>Total Power</td> <td>21.5 dBm</td> </tr> <tr> <td>Transmit Freq Error</td> <td>-45.796 kHz</td> <td>% of OBW Power</td> <td>99.00 %</td> </tr> <tr> <td>x dB Bandwidth</td> <td>9.170 MHz</td> <td>x dB</td> <td>-6.00 dB</td> </tr> </table> <p>Mar 15, 2021 6:40:21 PM</p>			Occupied Bandwidth	13.003 MHz	Total Power	21.5 dBm	Transmit Freq Error	-45.796 kHz	% of OBW Power	99.00 %	x dB Bandwidth	9.170 MHz	x dB	-6.00 dB
Occupied Bandwidth	13.003 MHz	Total Power	21.5 dBm											
Transmit Freq Error	-45.796 kHz	% of OBW Power	99.00 %											
x dB Bandwidth	9.170 MHz	x dB	-6.00 dB											

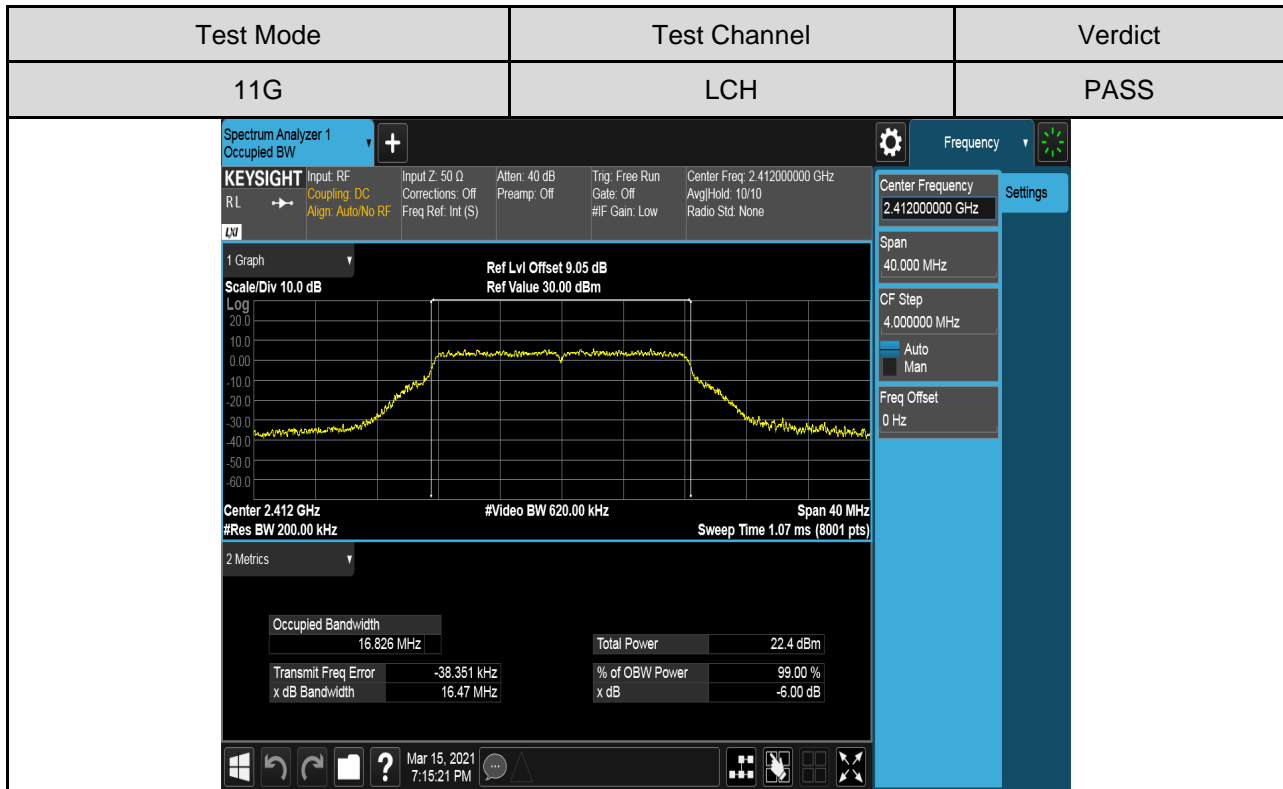
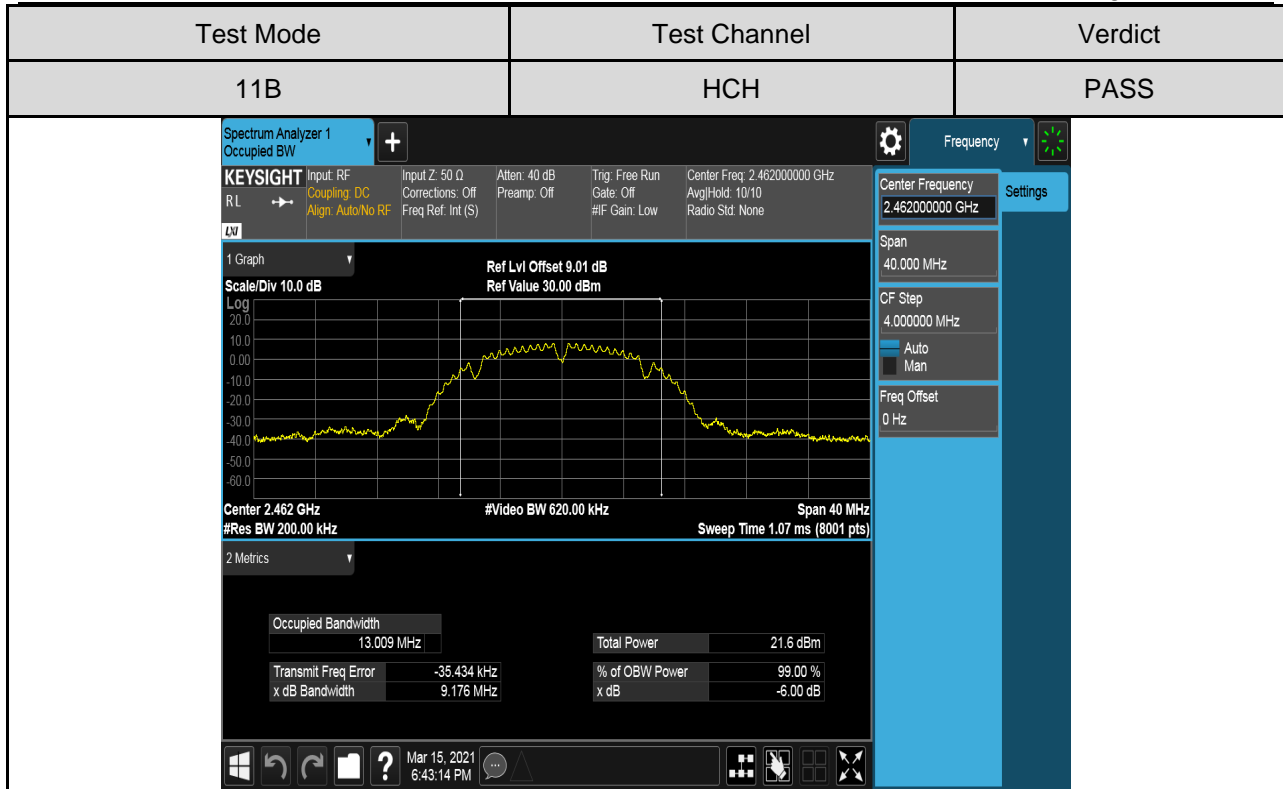

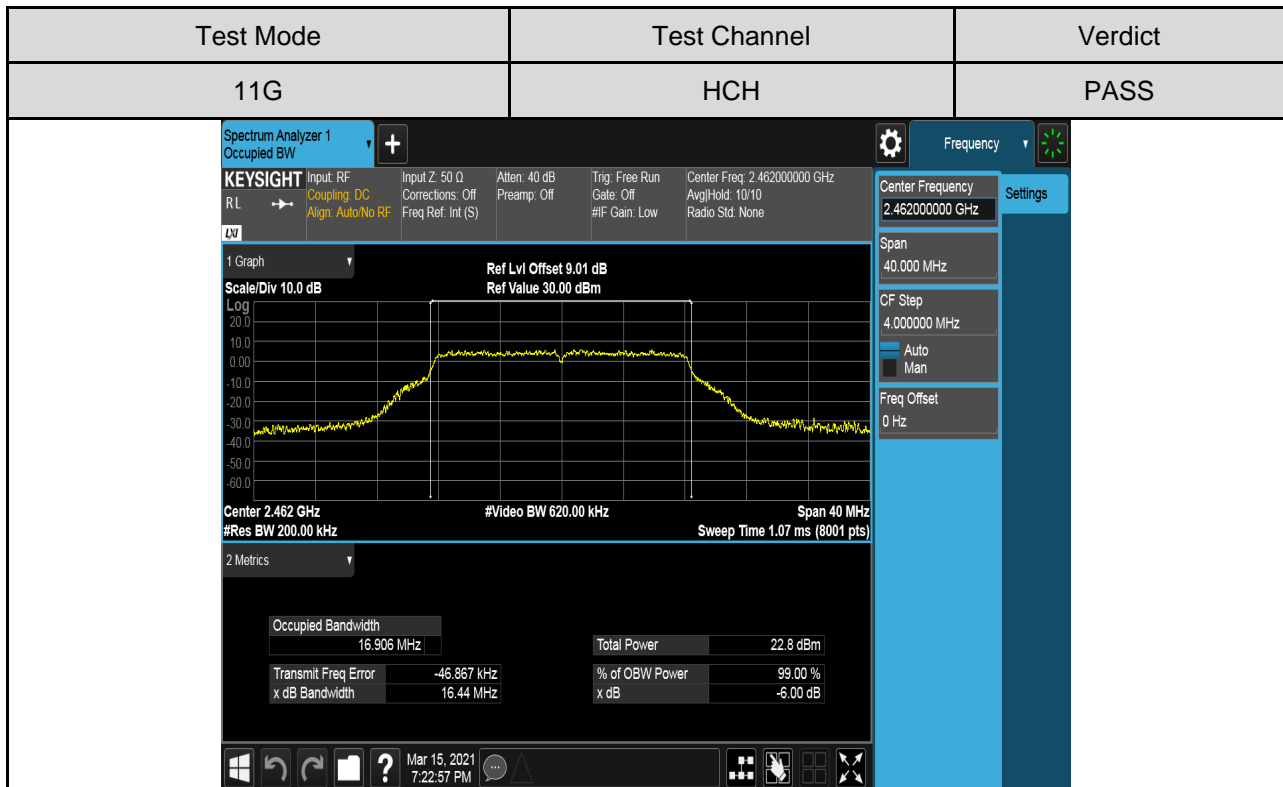
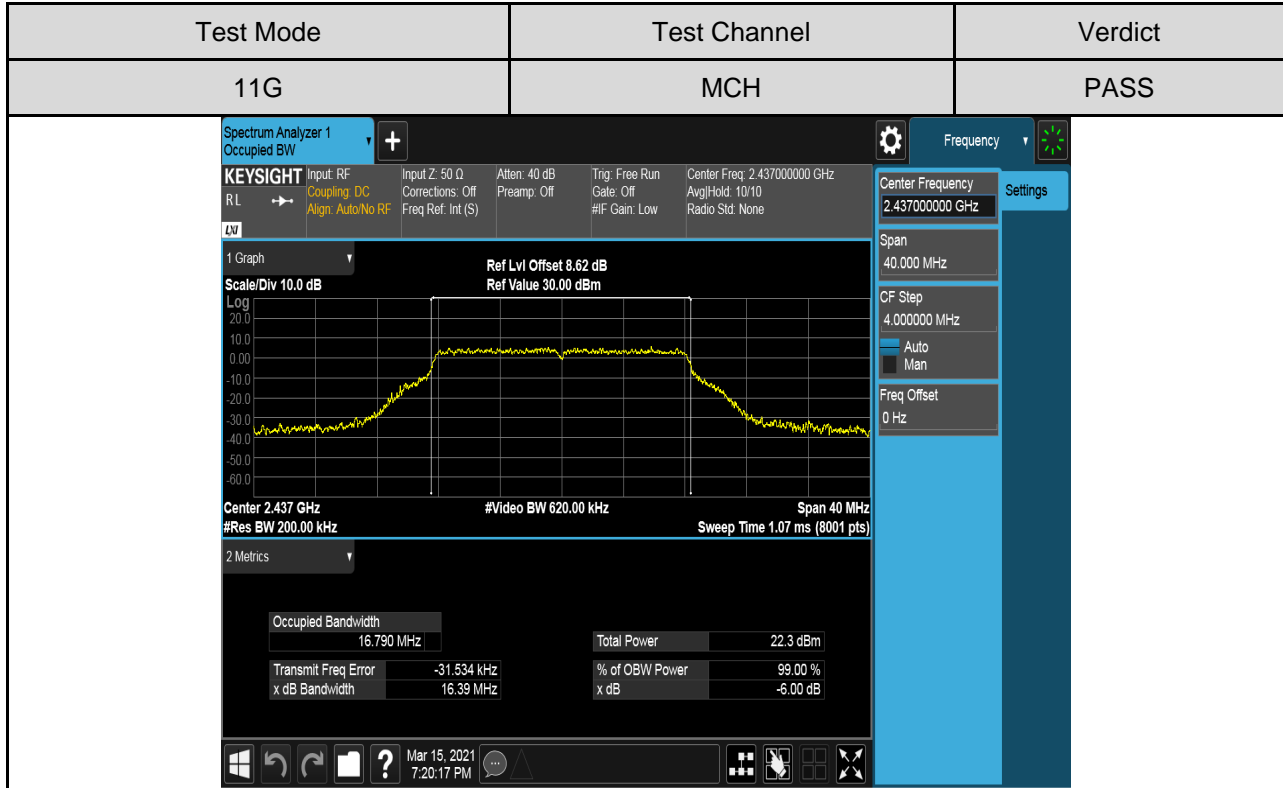

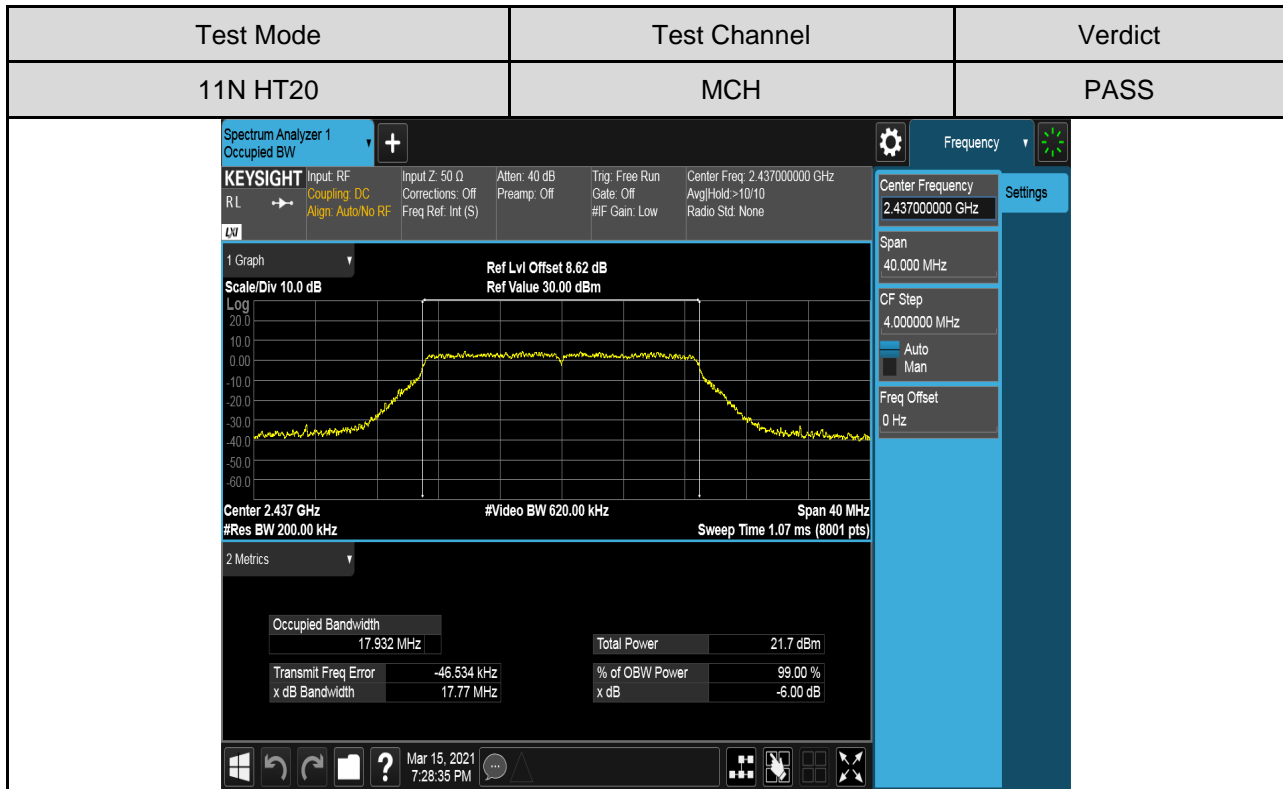

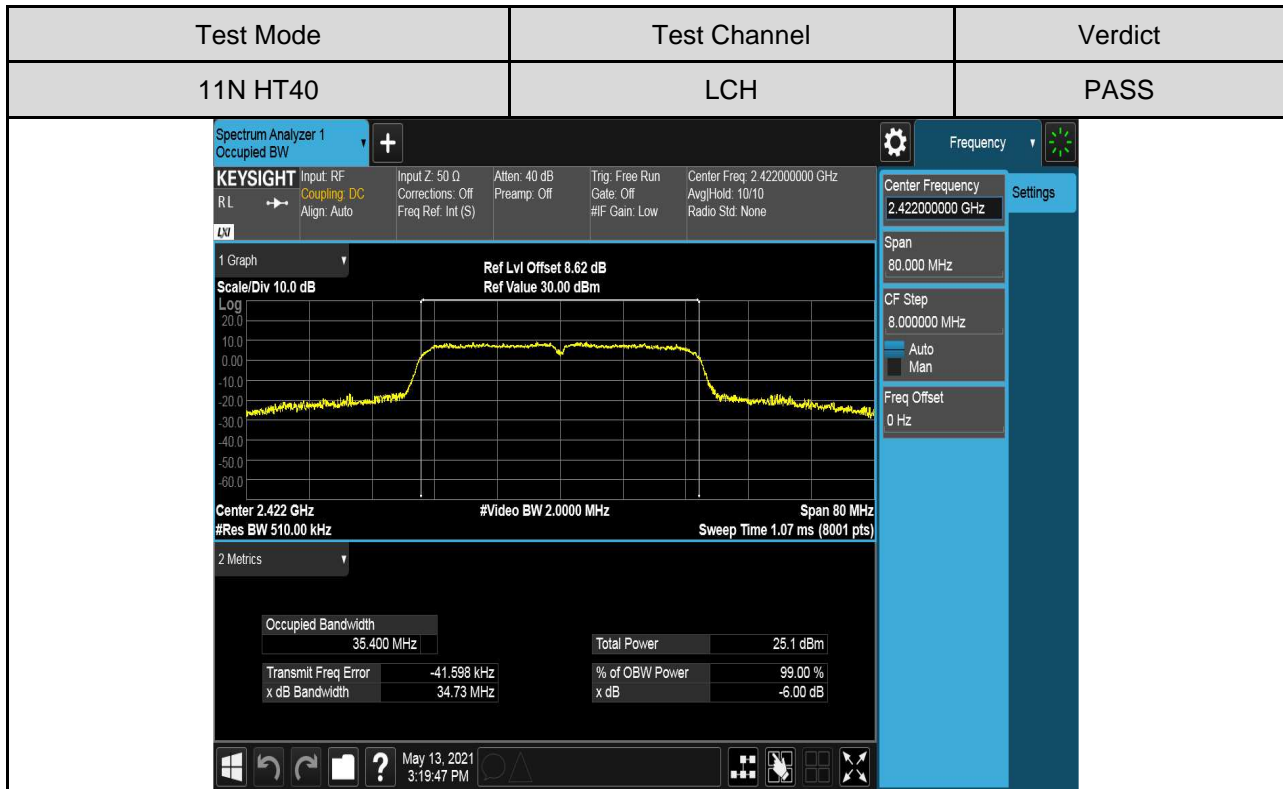
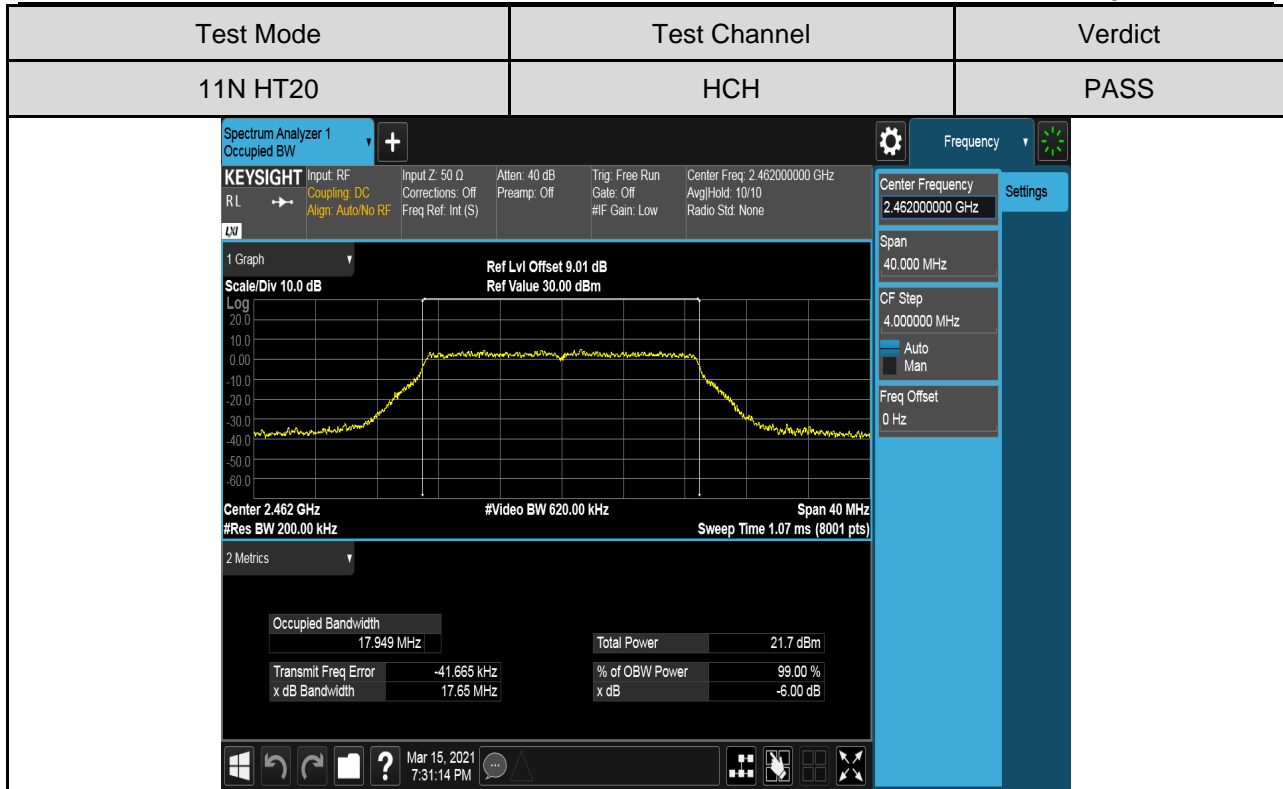

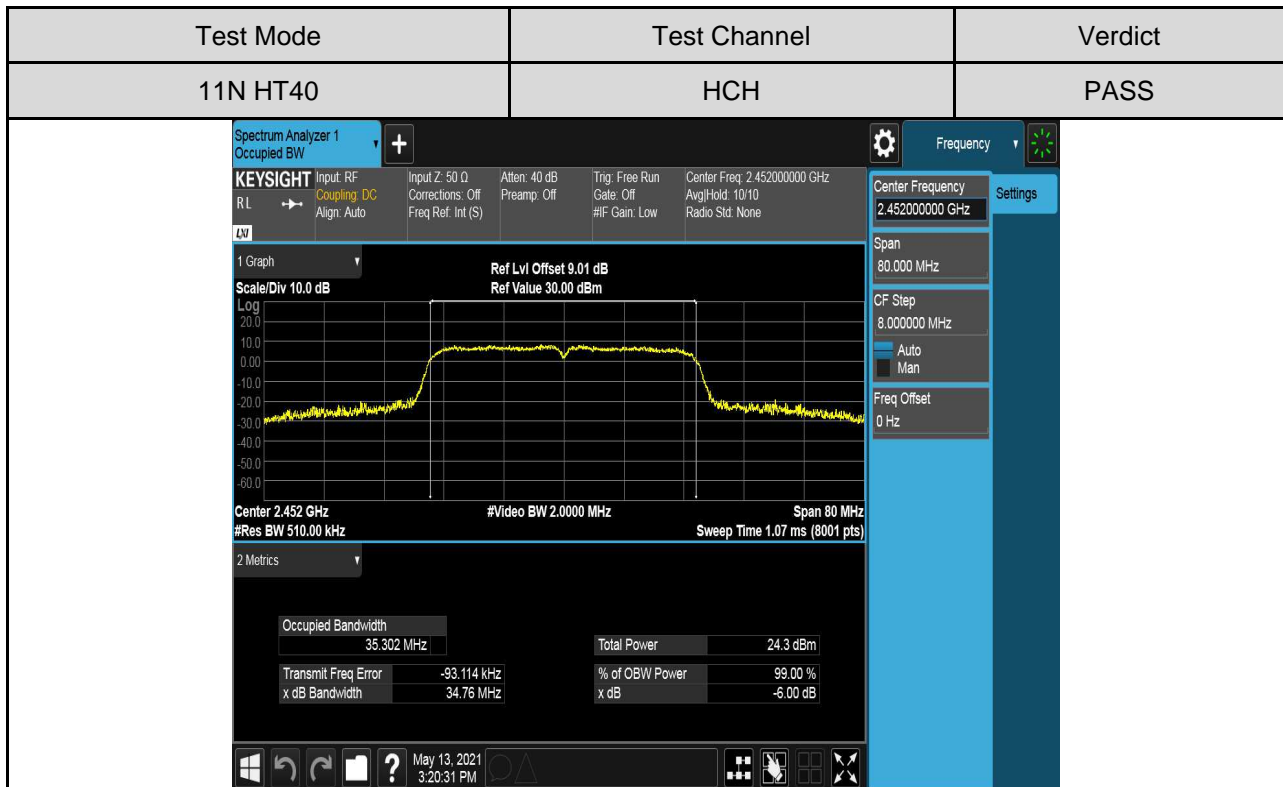
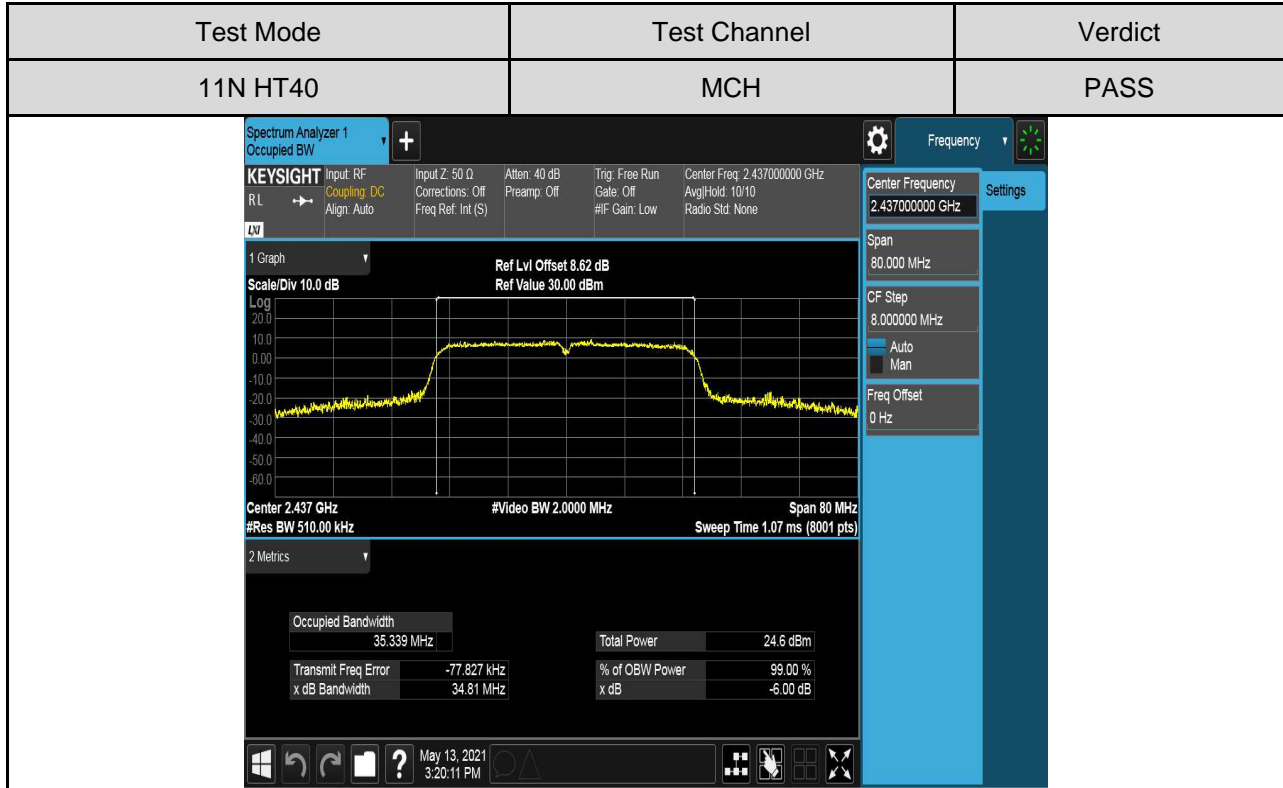

### 7.3. CONDUCTED POWER

#### LIMITS

FCC Part15 (15.247) Subpart C, , ISED RSS-247 ISSUE 2			
Section	Test Item	Limit	Frequency Range (MHz)
FCC 15.247(b)(3) ISED RSS-247 5.4 (d) RSS-Gen Clause 6.12	Output Power	1 watt or 30dBm	2400-2483.5

#### TEST PROCEDURE

Place the EUT on the table and set it in the transmitting mode.  
Remove the antenna from the EUT and then connect a low loss RF cable from the antenna port to the Power sensor.  
Measure the power of each channel.  
AVG Detector use for AVG result.

#### TEST SETUP

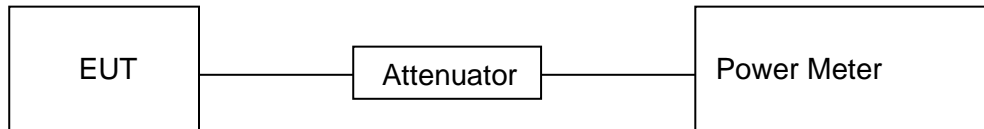



## RESULTS

For Normal Testing Part:

Test Mode	Test Channel	Maximum Conducted Output Power (AV)	Result
		dBm	
11B	LCH	19.44	Pass
	MCH	19.47	Pass
	HCH	19.65	Pass
11G	LCH	16.18	Pass
	MCH	18.92	Pass
	HCH	16.53	Pass
11N HT20	LCH	15.38	Pass
	MCH	18.01	Pass
	HCH	15.84	Pass
11N HT40	LCH	14.28	Pass
	MCH	17.50	Pass
	HCH	15.31	Pass

Remark:

- 1) For all the test results has been adjusted the duty cycle factor.
- 2) For Correction Factor is refer to the result in section 7.1

For Additions Testing Part:

Test Mode	Test Channel	Maximum Conducted Output Power (AV)	Result
		dBm	
11G	2422	18.96	Pass
	2452	19.65	Pass
11N HT20	2422	17.93	Pass
	2452	18.82	Pass
11N HT40	2432	17.45	Pass
	2442	17.81	Pass

Remark:

- 1) For all the test results has been adjusted the duty cycle factor.
- 2) For Correction Factor is refer to the result in section 7.1

## 7.4. POWER SPECTRAL DENSITY

### LIMITS

FCC Part15 (15.247) Subpart C, ISSED RSS-247 ISSUE 2			
Section	Test Item	Limit	Frequency Range (MHz)
FCC §15.247 (e) ISED RSS-247 5.2 (b)	Power Spectral Density	8 dBm in any 3 kHz band	2400-2483.5

### TEST PROCEDURE

Refer to FCC KDB 558074, connect the UUT to the spectrum analyser and use the following settings:

Center Frequency	The centre frequency of the channel under test
Detector	Peak
RBW	$3 \text{ kHz} \leq \text{RBW} \leq 100 \text{ kHz}$
VBW	$\geq 3 \times \text{RBW}$
Span	1.5 x DTS bandwidth
Trace	Max hold
Sweep time	Auto couple.

Allow trace to fully stabilize and use the peak marker function to determine the maximum amplitude level within the RBW.

If measured value exceeds limit, reduce RBW (no less than 3 kHz) and repeat.

### TEST ENVIRONMENT

Temperature	22°C	Relative Humidity	56%
Atmosphere Pressure	101kPa	Test Voltage	AC 120V

### TEST SETUP

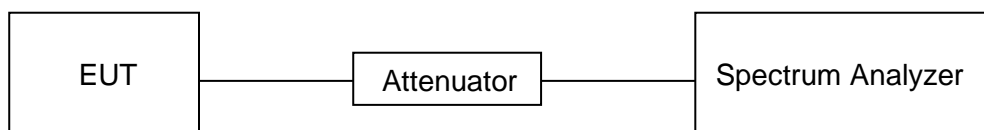



**RESULTS**

For Normal Testing Part:

Test Mode	Test Channel	Maximum Peak power spectral density (dBm/10kHz)	Result
11B	LCH	2.21	Pass
	MCH	1.17	Pass
	HCH	3.04	Pass
11G	LCH	-3.56	Pass
	MCH	-0.21	Pass
	HCH	-3.66	Pass
11N HT20	LCH	-2.84	Pass
	MCH	-1.12	Pass
	HCH	-2.41	Pass
11N HT40	LCH	-7.04	Pass
	MCH	-4.29	Pass
	HCH	-6.11	Pass

For Additions Testing Part:

Test Mode	Test Channel	Maximum Peak power spectral density (dBm/10kHz)	Result
		dBm	
11G	2422	-0.30	Pass
	2452	0.53	Pass
11N HT20	2422	-0.15	Pass
	2452	-0.92	Pass
11N HT40	2432	-3.92	Pass
	2442	-3.38	Pass



**Test Graphs:**

For Normal Testing Part:

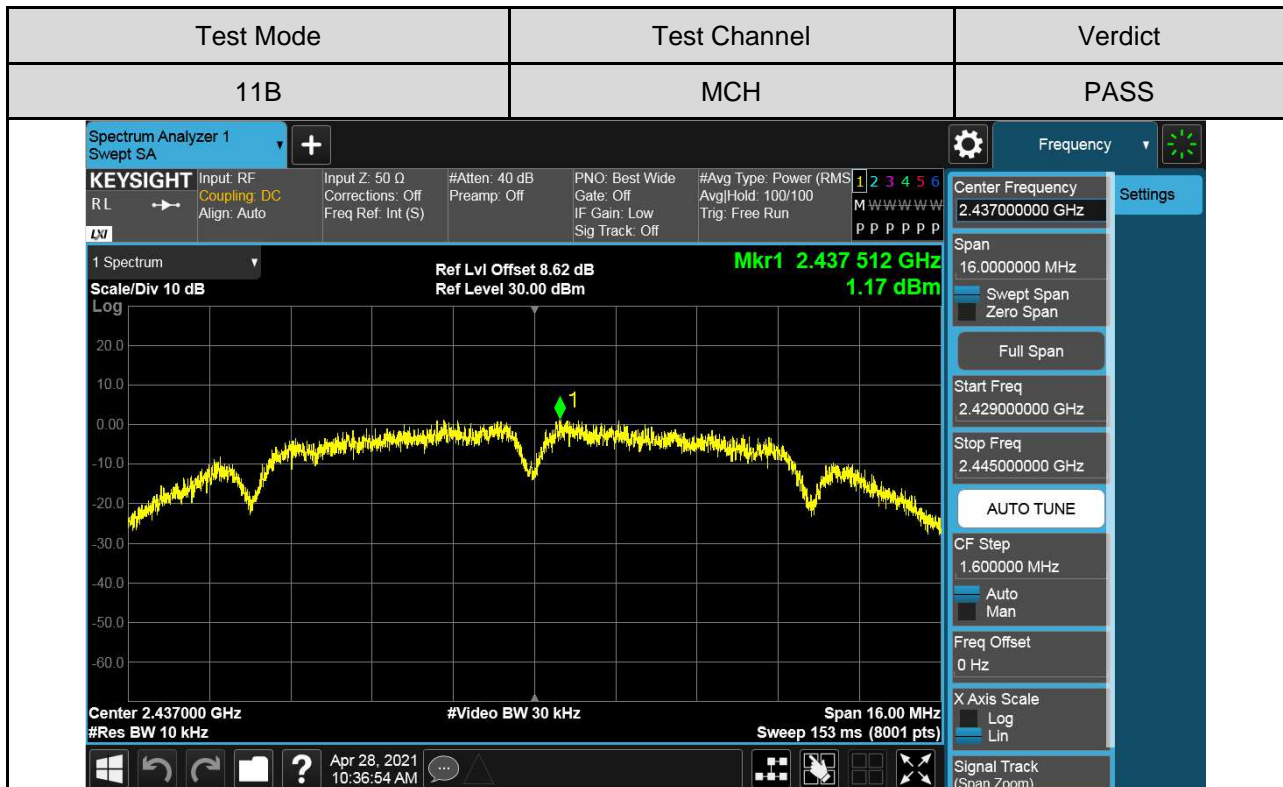
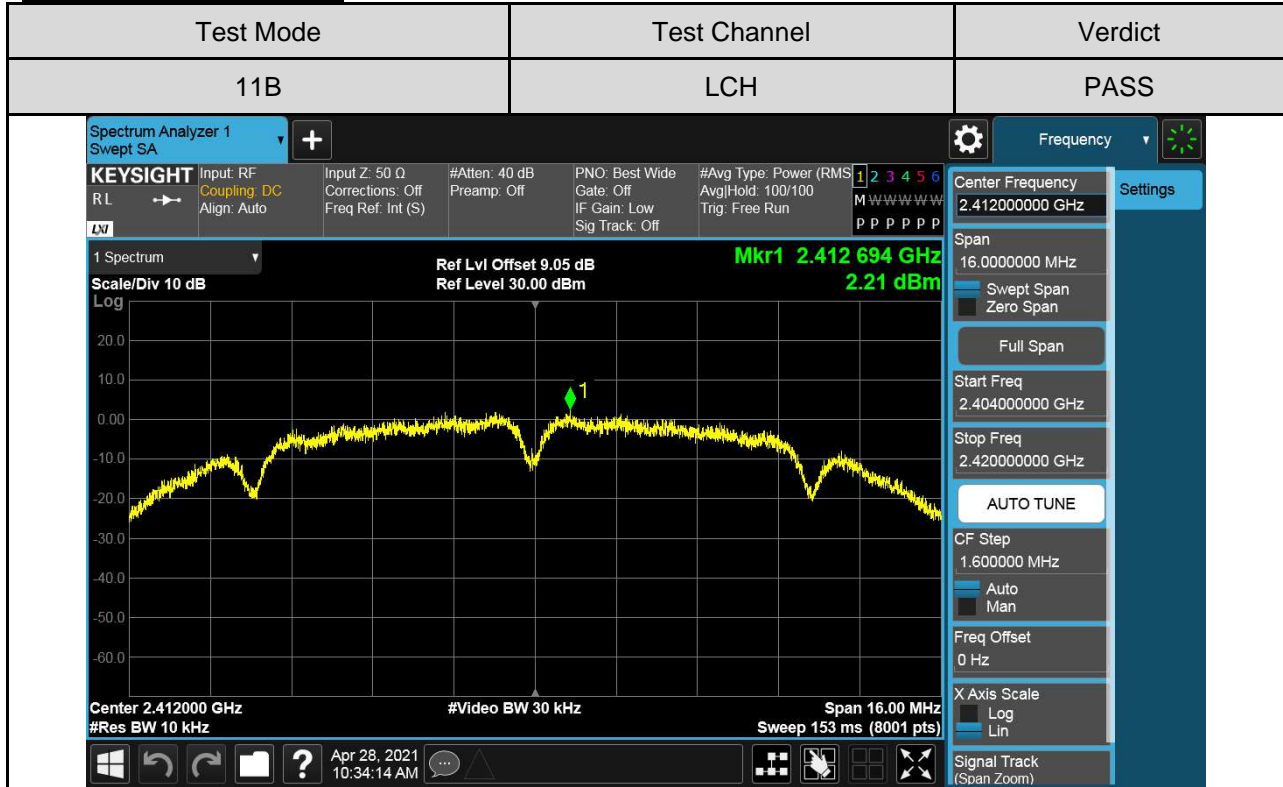

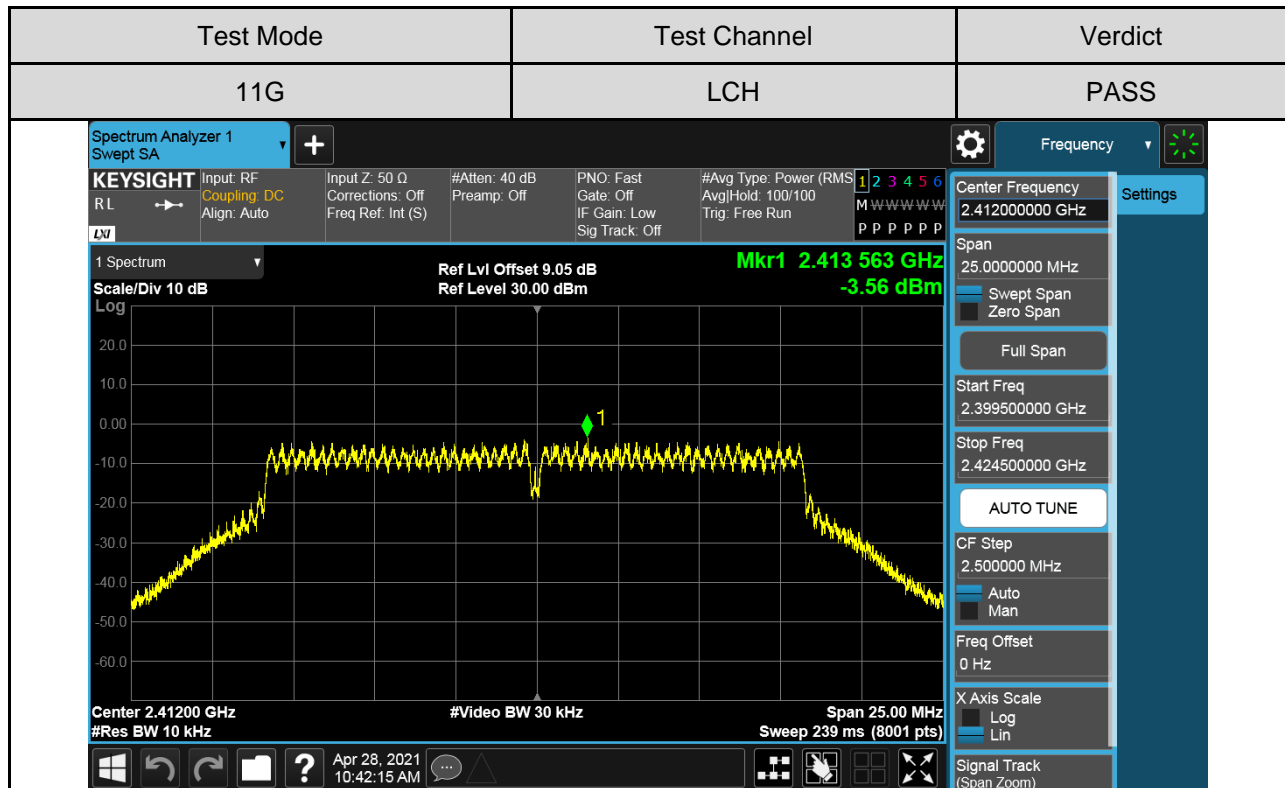
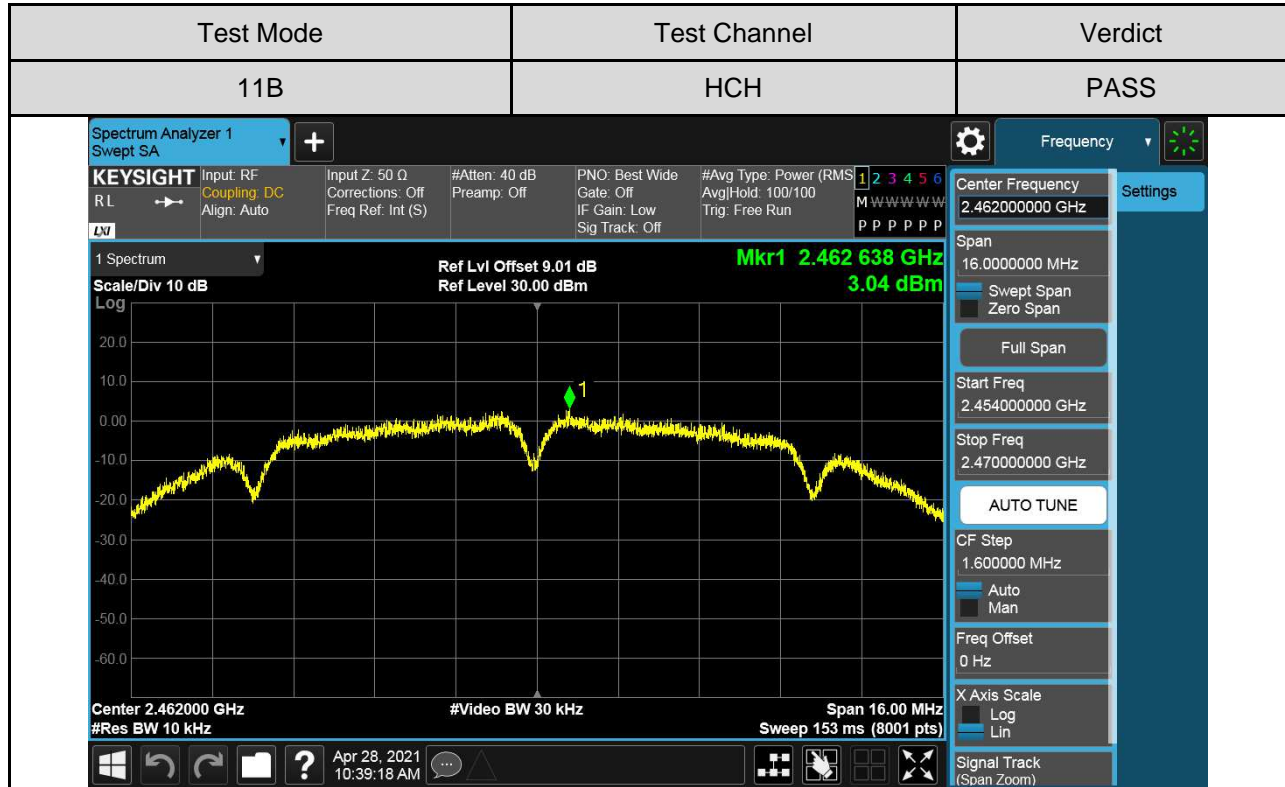

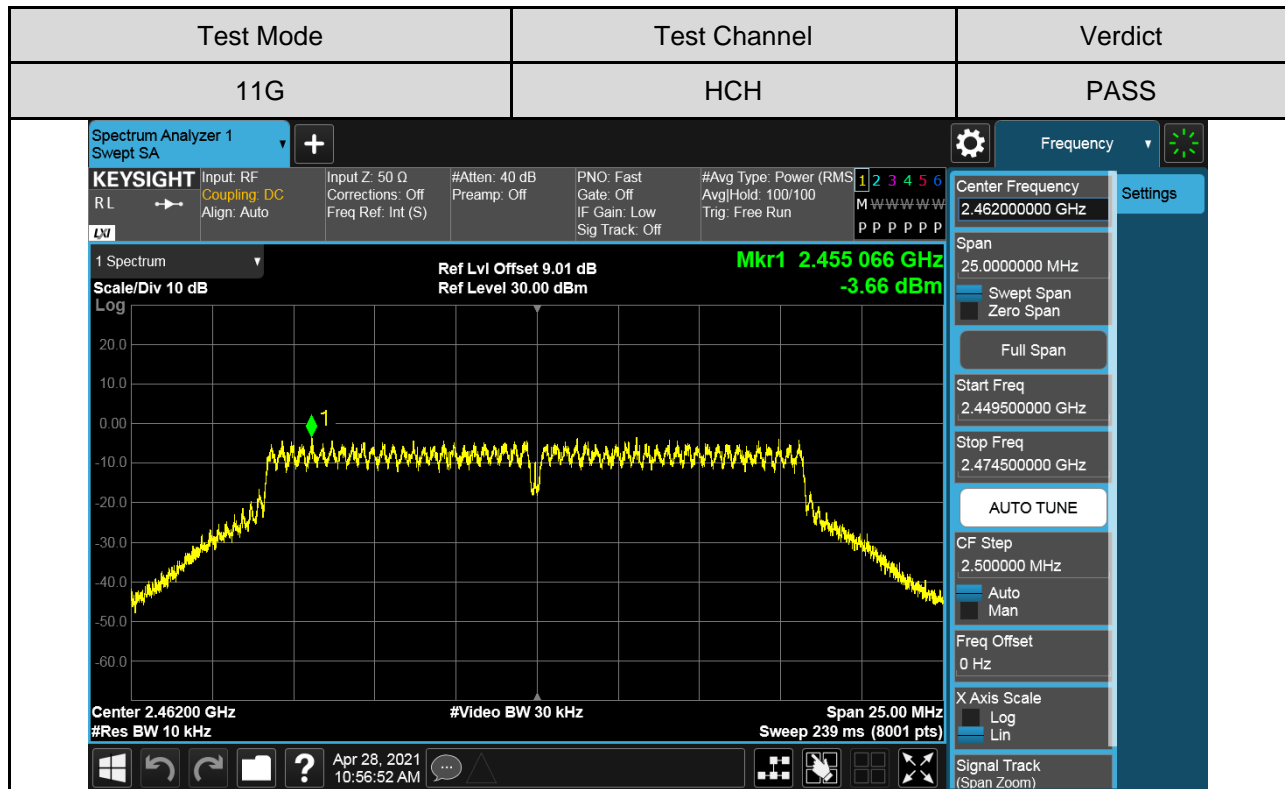
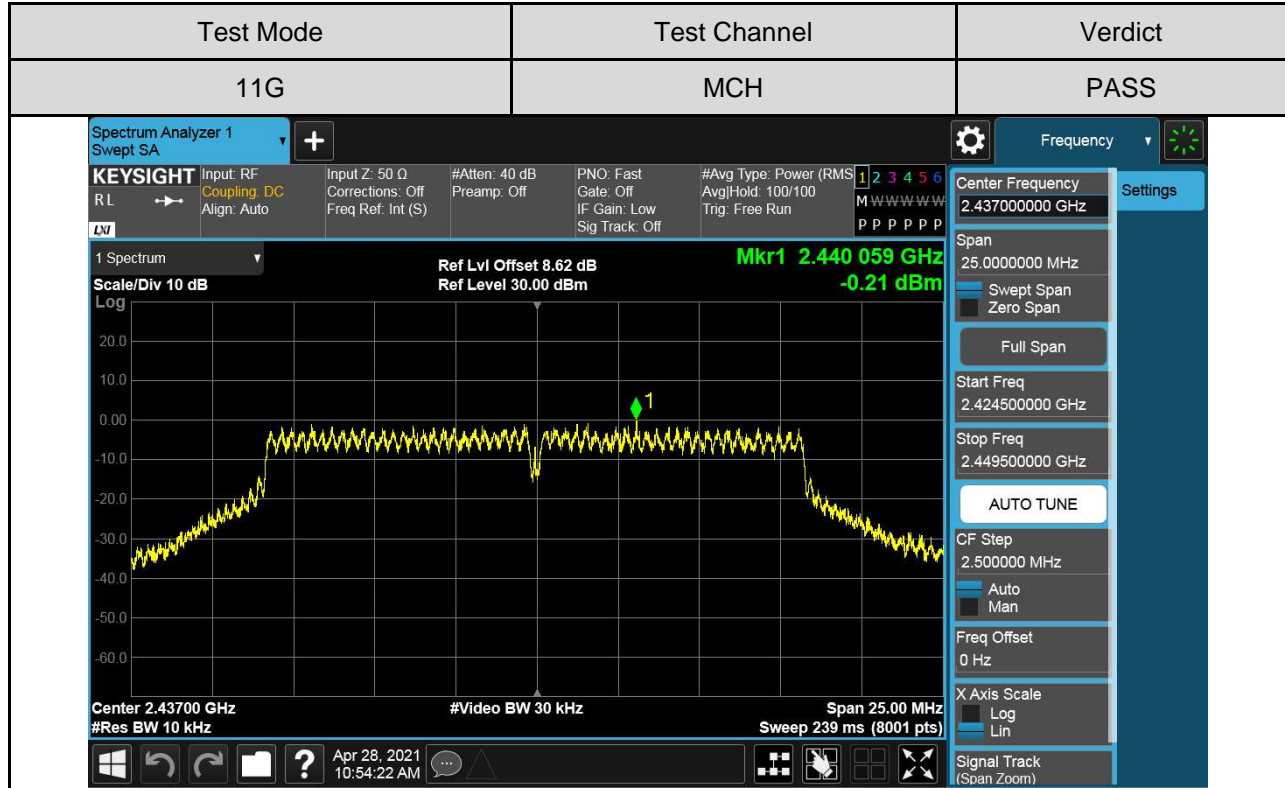

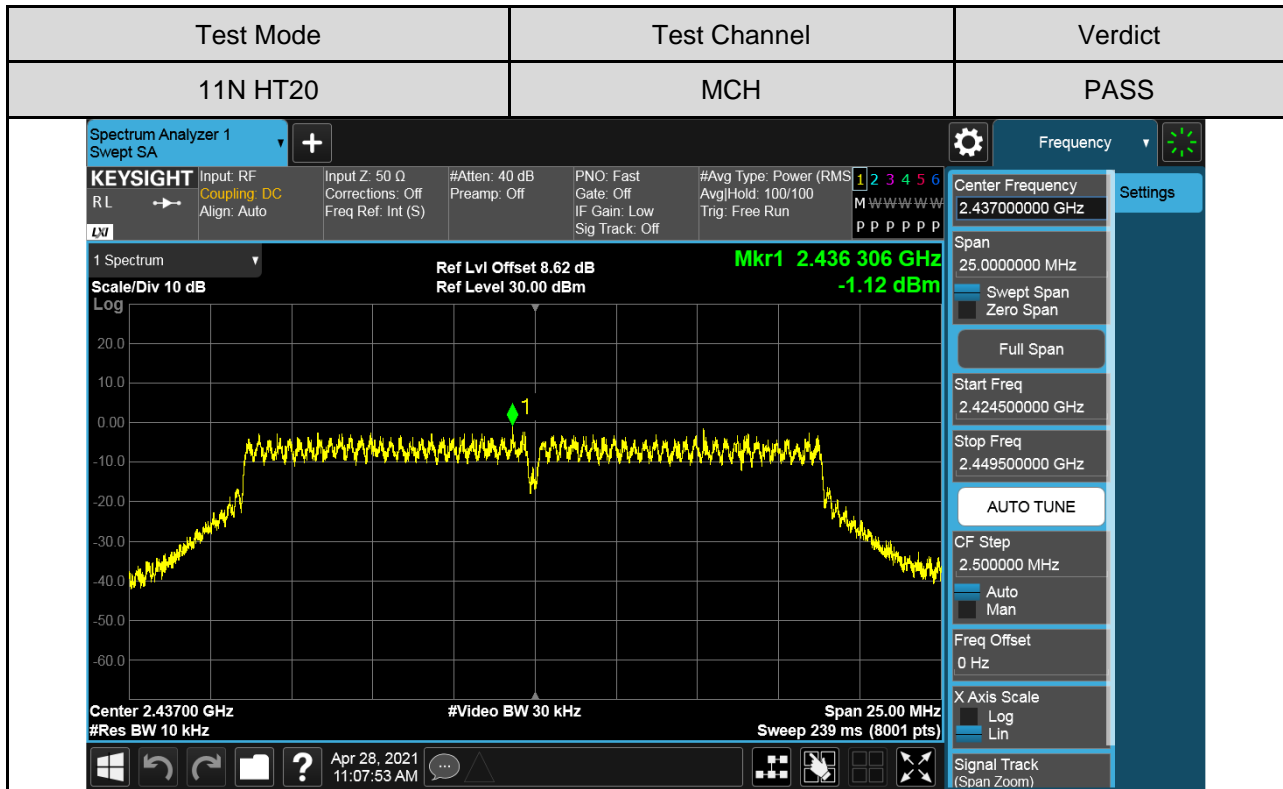
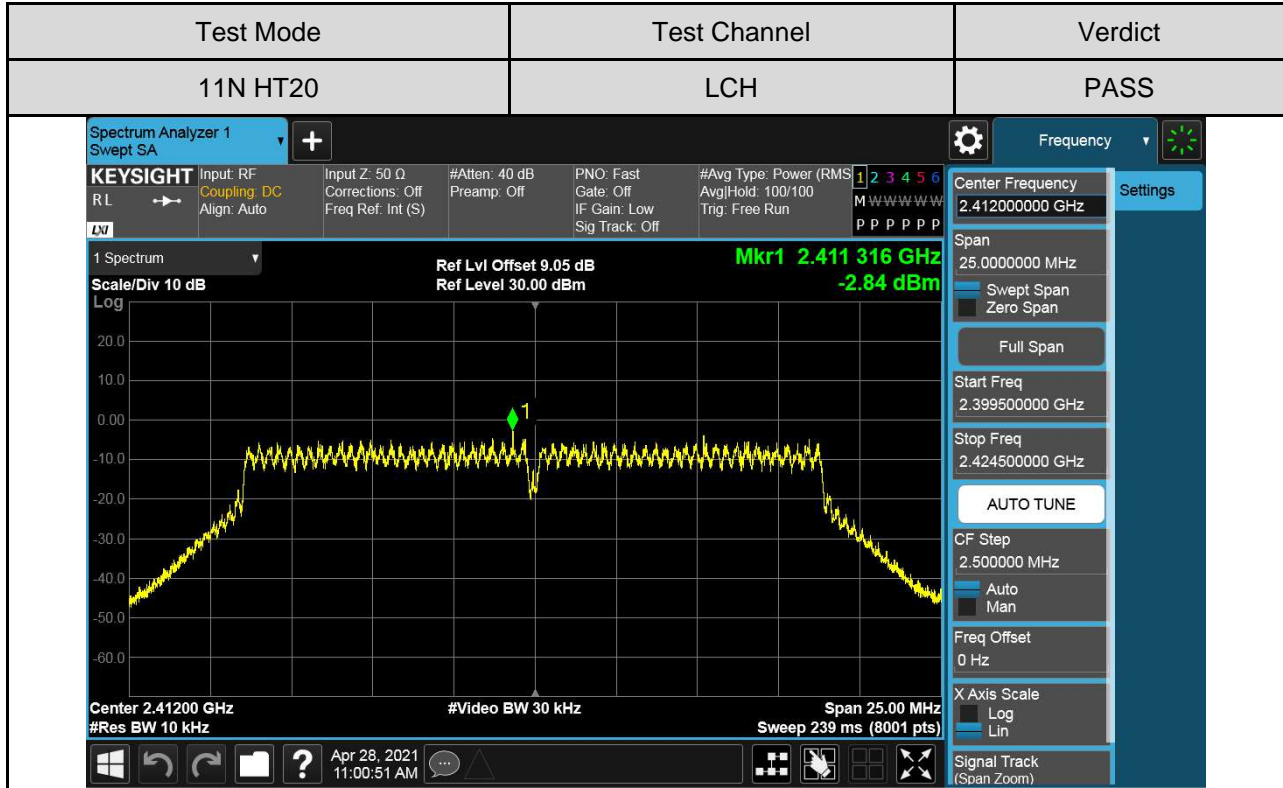

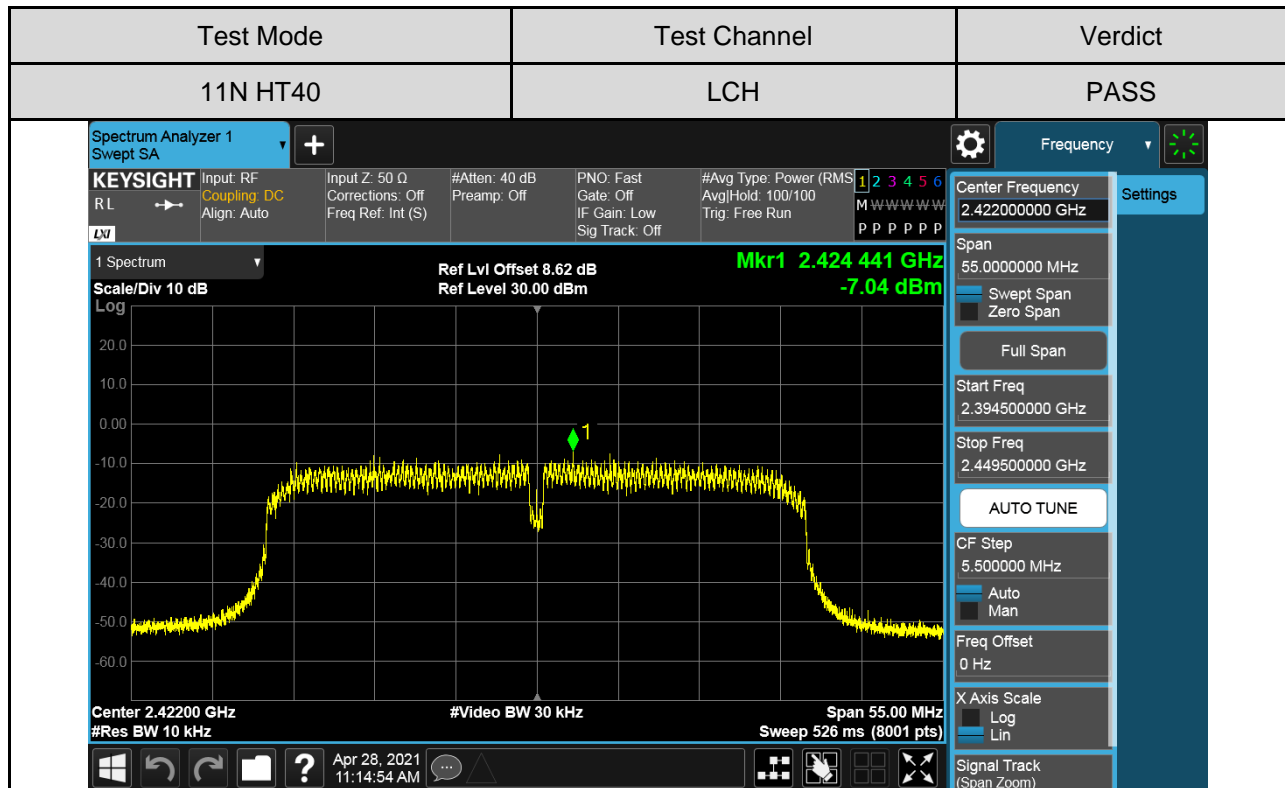
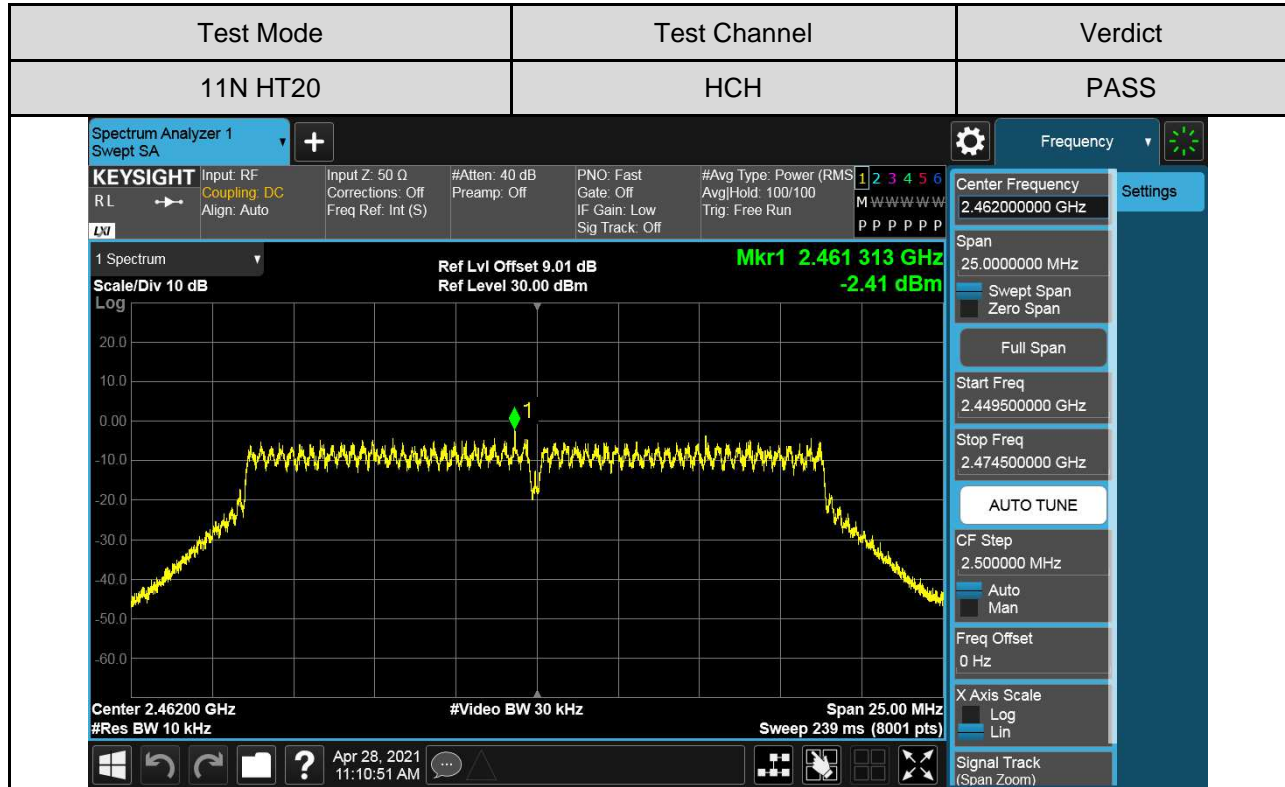

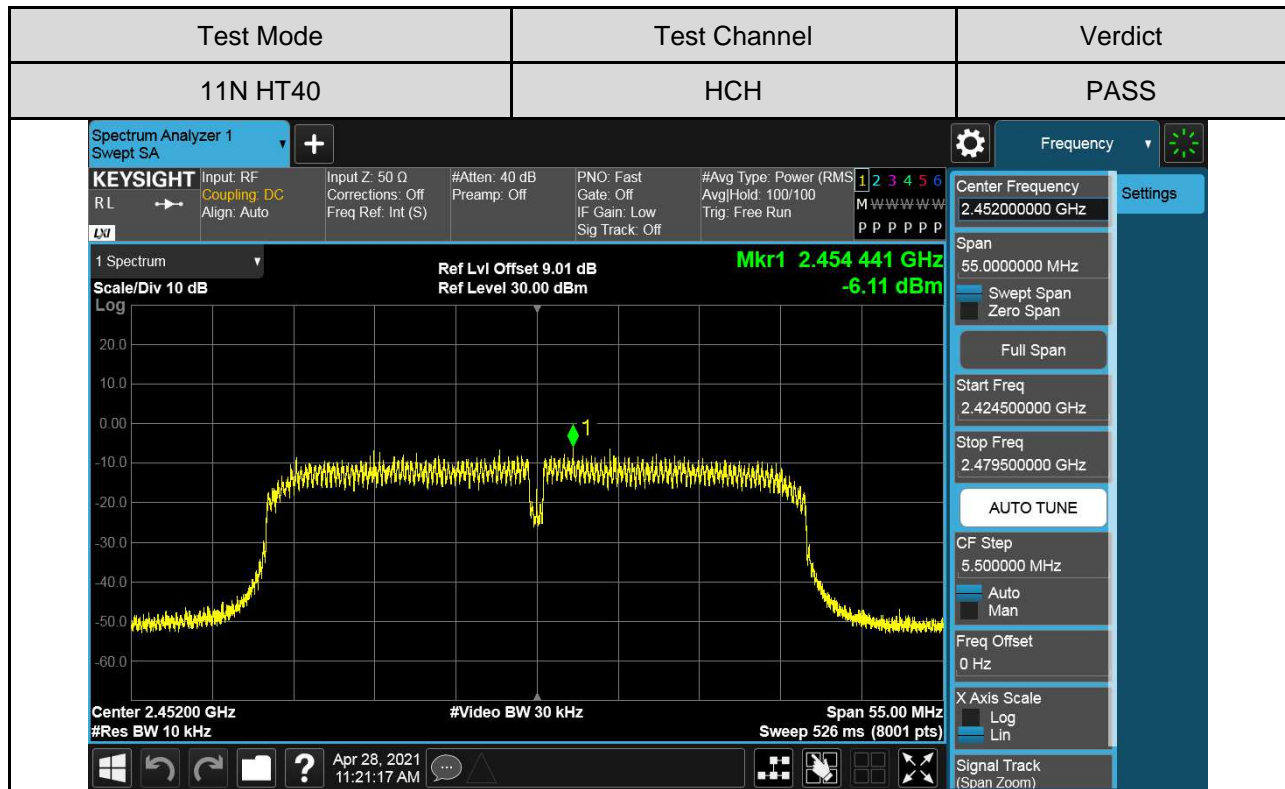
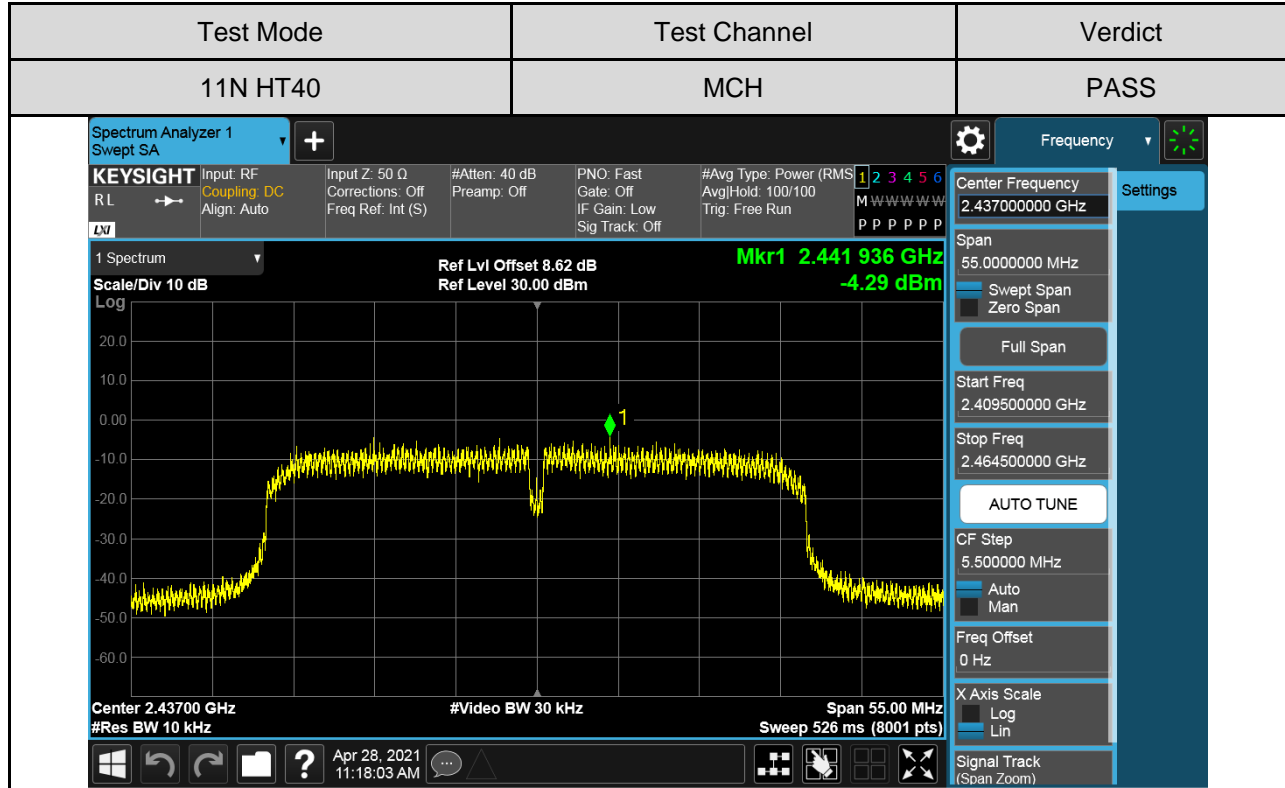



For Additions Testing Part:

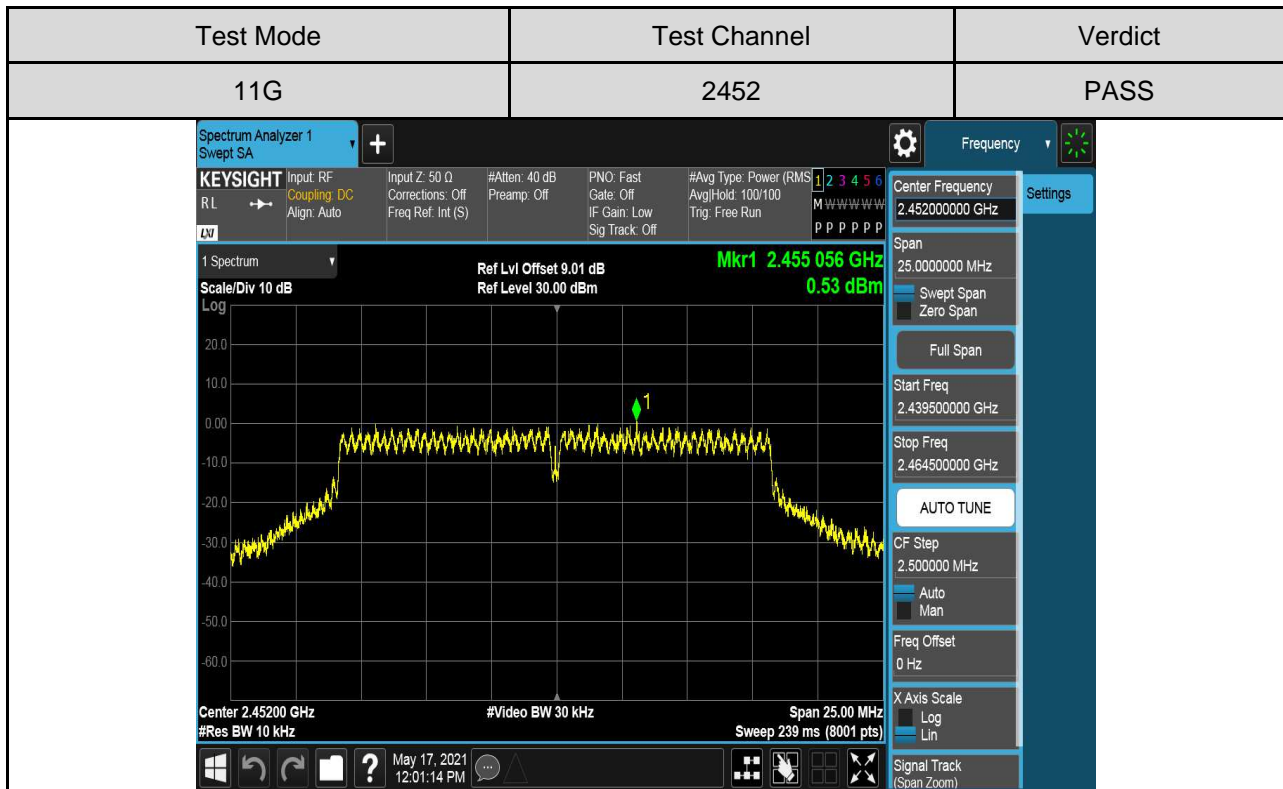
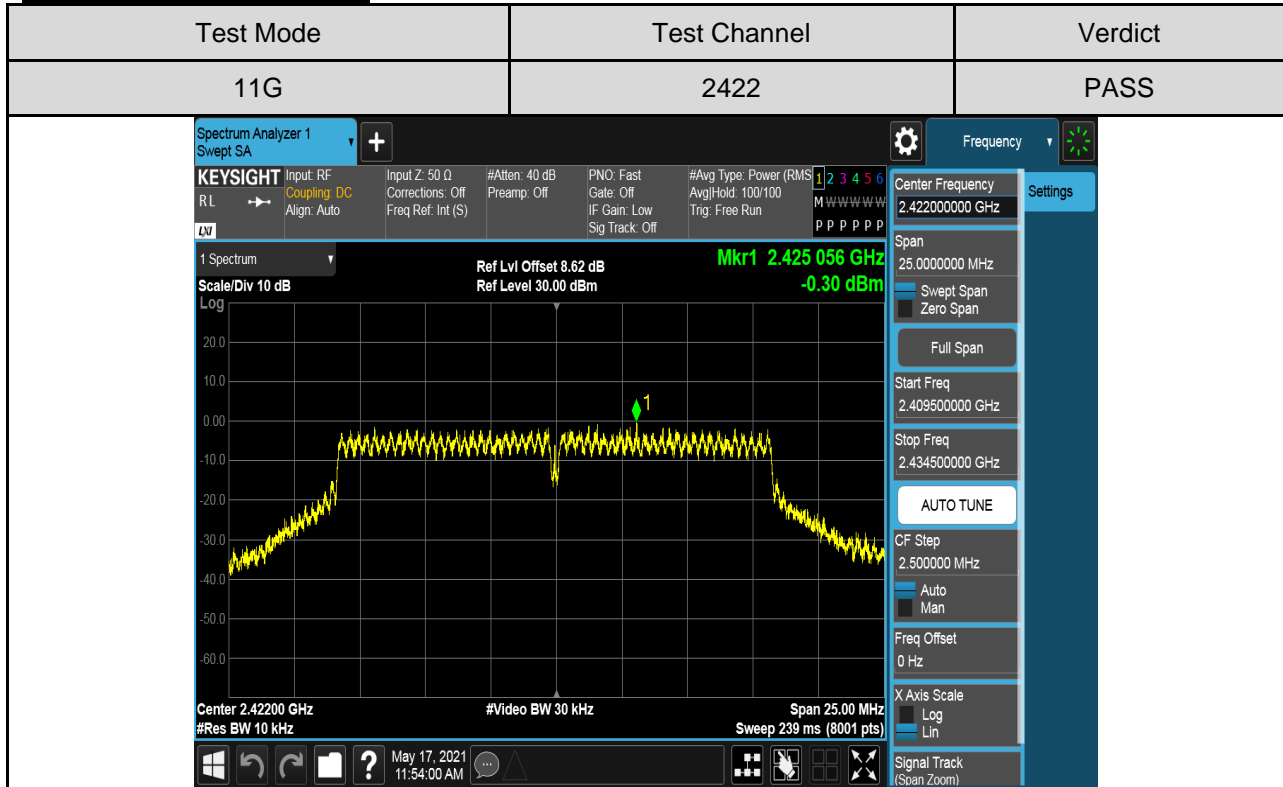

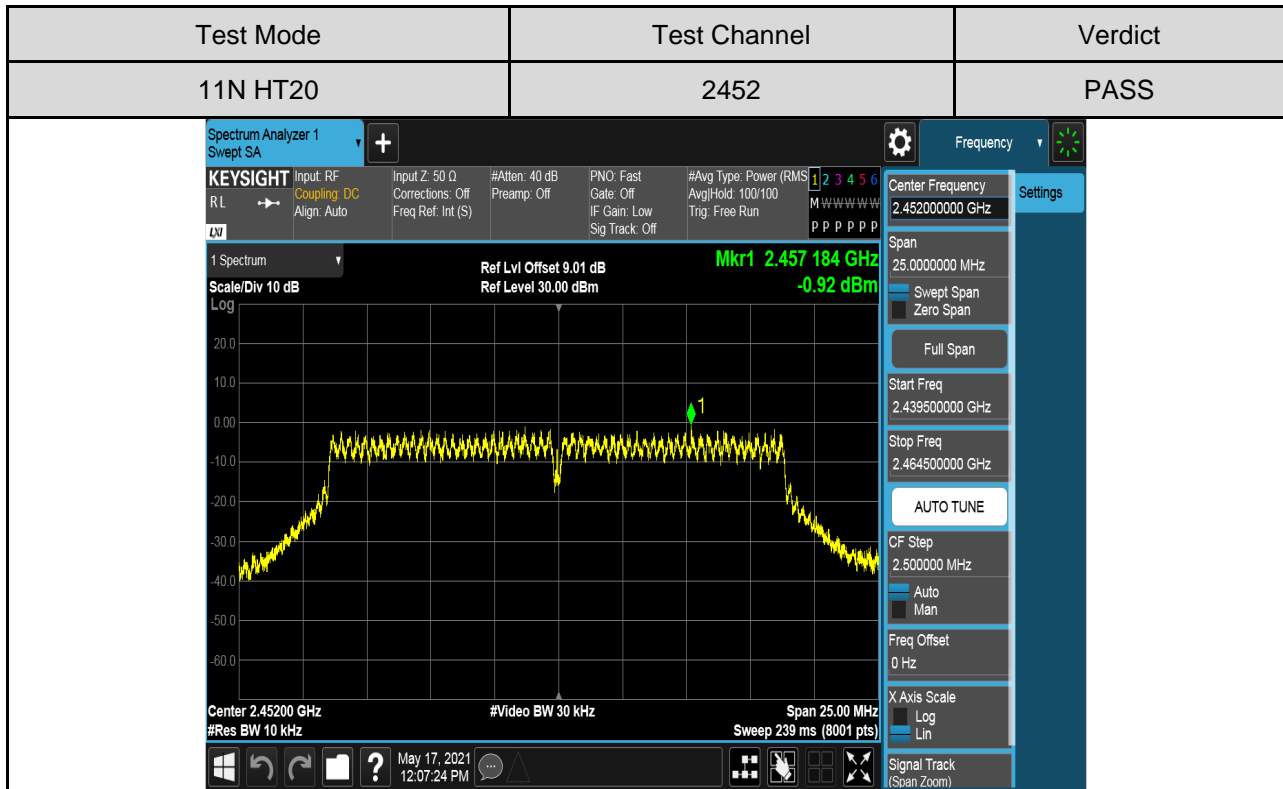
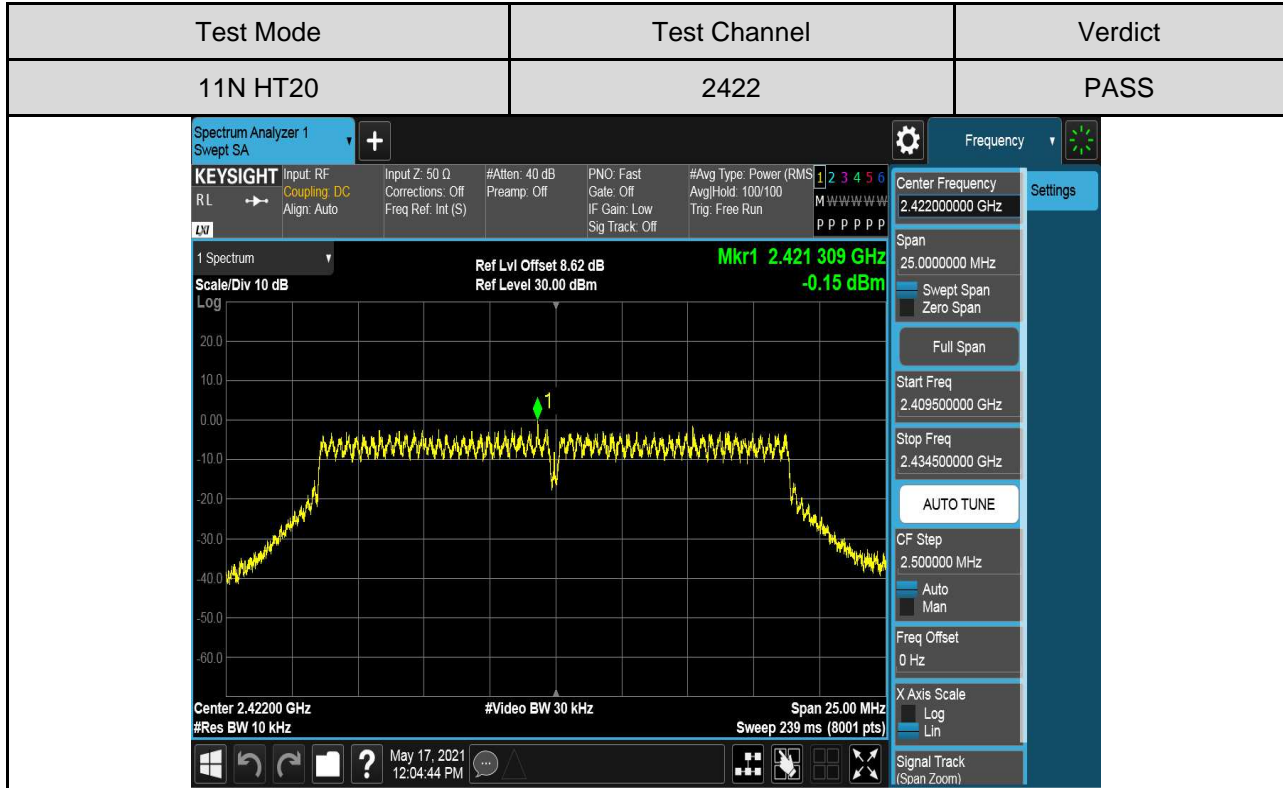

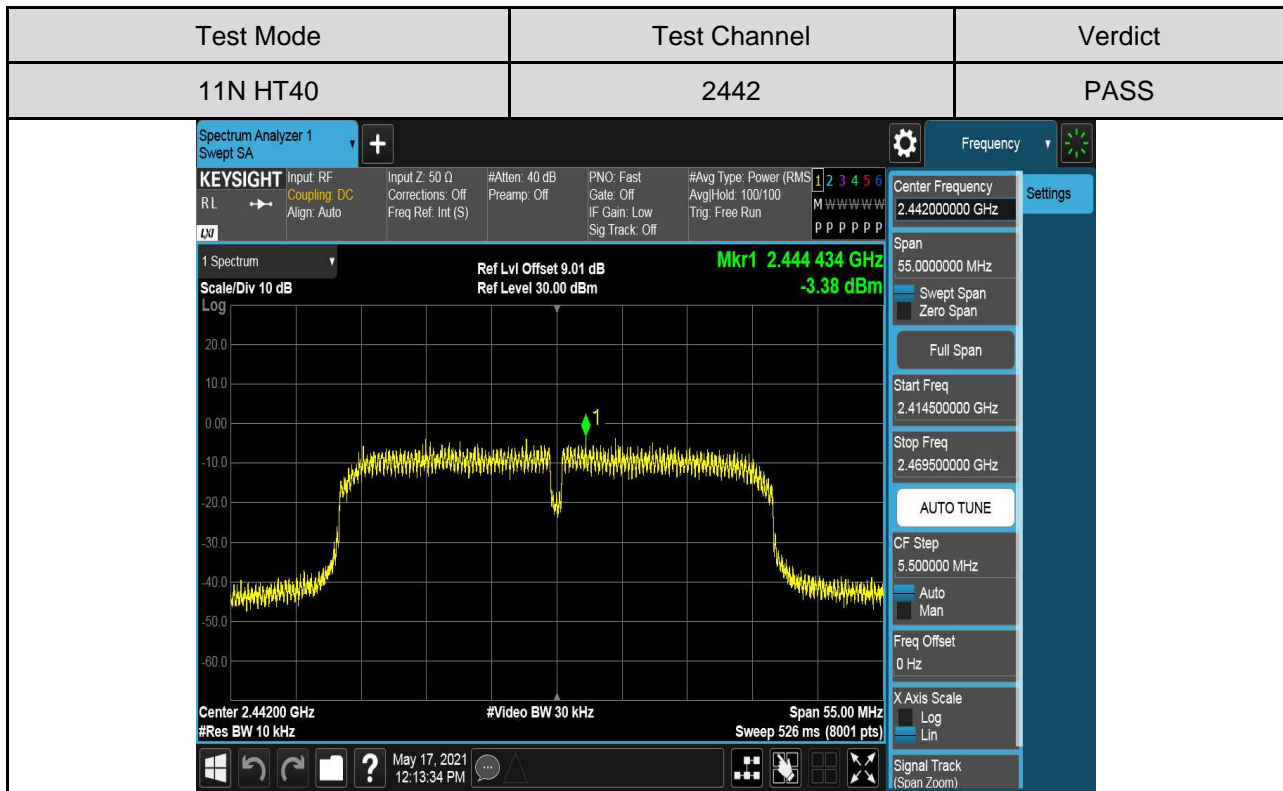
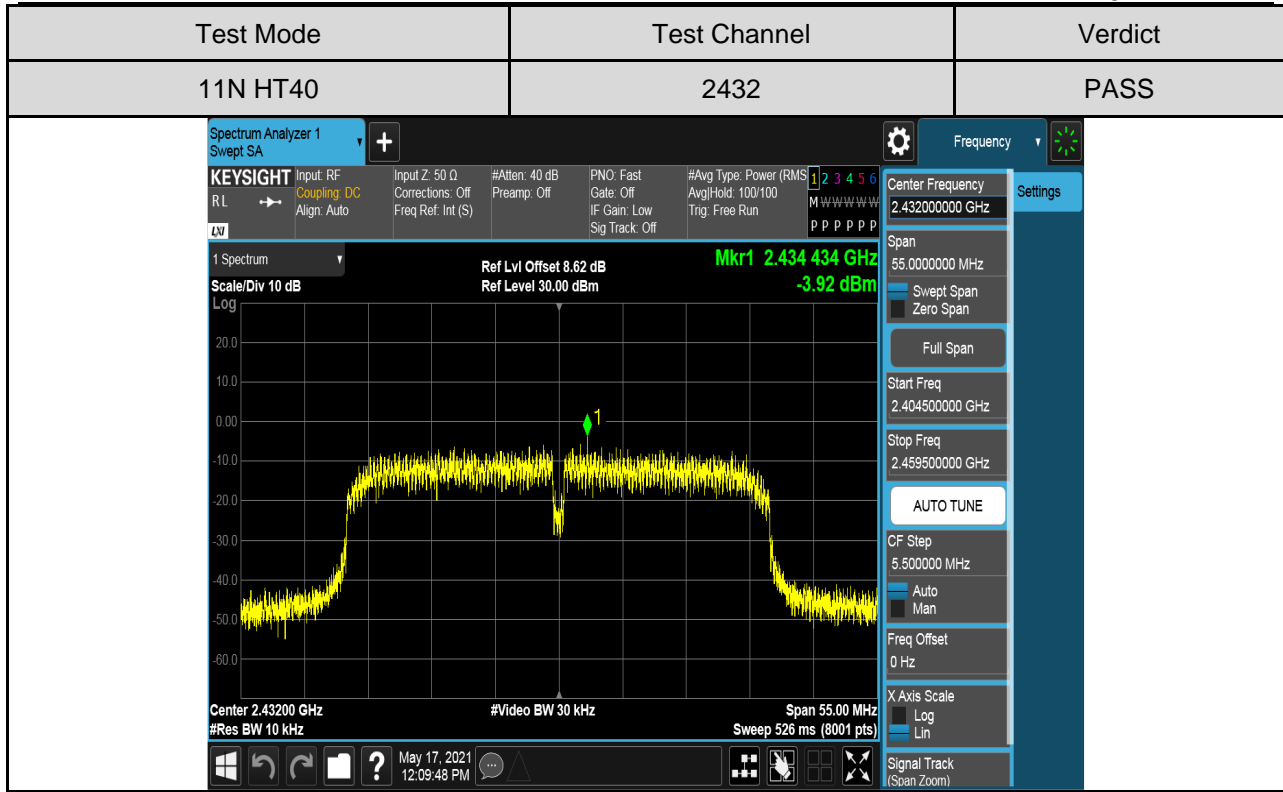



## 7.5. CONDUCTED BANDEGE AND SPURIOUS EMISSIONS

### LIMITS

FCC Part15 (15.247) Subpart C, ISED RSS-247 ISSUE 2		
Section	Test Item	Limit
FCC §15.247 (d) RSS-247 Clause 5.5 RSS-GEN Clause 6.13	Conducted Bandedge and Spurious Emissions	At least 30 dB below that in the 100 kHz bandwidth within the band that contains the highest level of the desired power

### TEST PROCEDURE

Refer to FCC KDB 558074, connect the UUT to the spectrum analyser and use the following

Center Frequency	The centre frequency of the channel under test
Detector	Peak
RBW	100K
VBW	$\geq 3 \times \text{RBW}$
Span	1.5 x DTS bandwidth
Trace	Max hold
Sweep time	Auto couple.

settings:

Use the peak marker function to determine the maximum PSD level.

Span	Set the center frequency and span to encompass frequency range to be measured
Detector	Peak
RBW	100K
VBW	$\geq 3 \times \text{RBW}$
measurement points	$\geq \text{span}/\text{RBW}$
Trace	Max hold
Sweep time	Auto couple.

Use the peak marker function to determine the maximum amplitude level.

### TEST SETUP

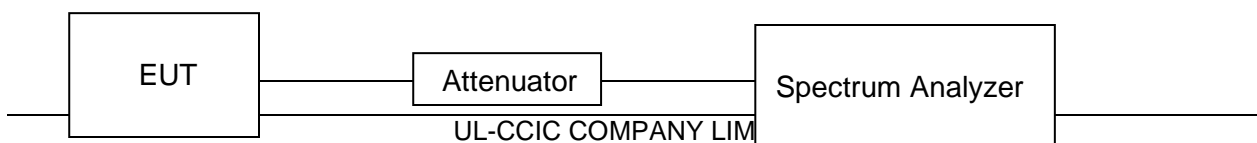



**TEST ENVIRONMENT**

Temperature	22°C	Relative Humidity	56%
Atmosphere Pressure	101kPa	Test Voltage	AC 120V



**Part I :Conducted Bandedge**

**RESULTS TABLE**

For Normal Testing Part:

Test Mode	Test Channel	Carrier Power[dBm]	Max. Spurious Level [dBm]	Limit [dBm]	Verdict
11B	LCH	10.75	-39.37	-19.25	PASS
	HCH	11.22	-40.17	-18.78	PASS
11G	LCH	4.118	-38.64	-25.88	PASS
	HCH	4.435	-34.82	-25.57	PASS
11N HT20	LCH	3.610	-39.14	-26.39	PASS
	HCH	3.264	-39.02	-26.74	PASS
11N HT40	LCH	0.372	-38.91	-29.63	PASS
	HCH	1.150	-38.40	-28.85	PASS

For Additions Testing Part:

Test Mode	Test Channel	Carrier Power[dBm]	Max. Spurious Level [dBm]	Limit [dBm]	Verdict
11G	2422	8.049	-39.47	-21.95	PASS
	2452	8.599	-38.86	-21.40	PASS
11N HT20	2422	6.647	-39.30	-23.35	PASS
	2452	7.520	-39.14	-22.48	PASS
11N HT40	2422	3.348	-37.12	-26.65	PASS
	2452	4.156	-36.41	-25.84	PASS



**TEST GRAPHS**

For Normal Testing Part:

