

RESOLUCION 737 - SUBTEL

Fecha de publicación: 10/2/2026

Información Comercial

Nombre comercial del equipo

Código	Descripción
929002422701	Hue Play gradient lightstrip 55" EU
929002422801	Hue Play gradient lightstrip 65" EU

Fabricante: Signify (China) Investment Co., Ltd.

Importador o representante en Chile: SIGNIFY CHILENA S.A.

Domicilio: El Bosque Norte 0211, Las Condes - Santiago

Correo electrónico de contacto: tomas.aragona@signify.com

Sitio Web: philips-hue.com/es-cl

Características técnicas

Tipo de equipo	Hue Play Gradient Lightstrip (Tiras LED)
Marca	HUE
Modelo	9290024227, 9290024228
Módulo	Hue Connect
Tecnología o modulación	O-QPSK (Zigbee), GFSK (BT)
Frecuencias	BT: 2402-2480; ZigBee: 2405-2480 MHz.
Ganancia de antena (dBi)	2.08 dBi
P.I.R.E. (EIRP)	BT: 14,75 mW (11,69 dBm); ZigBee: 14,82 mW (11,71 dBm)

Declaración de conformidad

“El equipo previamente individualizado cumple con las disposiciones establecidas en la Norma Técnica de Equipos de alcance reducido, aprobada por la resolución exenta N° 1.985, de 2017, de la Subsecretaría de Telecomunicaciones.”

Firma del Importador/Responsable:

Nombre de quien firma: Tomás



Aragona

Cargo: Representante Legal

/DO N° 105828/F60

- ANT.: 1. Ingreso SUBTEL N° 36820 de 18.03.2024.
2. Resolución Exenta N° 1985 de 2017, y sus modificaciones, de la Subsecretaría de Telecomunicaciones
3. Resolución Exenta N° 3.103 de 2012, de la Subsecretaría de Telecomunicaciones.
4. Resolución Exenta N° 470 de fecha 13.02.2013, que faculta a los jefes de División y de Departamento para firmar "Por Orden del Subsecretario de Telecomunicaciones" y delega las facultades que indica.

MAT.: Certifica equipo de alcance reducido.

DE: SUBSECRETARÍA DE TELECOMUNICACIONES

A: MBSERVICES

1. De acuerdo a la información proporcionada por documento de ANT. 1), esta Subsecretaría de Estado extiende el presente certificado para operar dentro del país, condicionado al estricto cumplimiento de lo señalado en letra(s) j.1) del artículo 1° de la norma señalada en ANT. 2):

- Tipo de Equipo : Hue Play Gradient Lightstrip (Tiras LED).
- Marca : HUE.
- Modelo(s) : 9290024227, 9290024228
- Fabricante : Signify (China) Investment Co., Ltd.
- Frecuencias de operación : BT: 2402-2480; ZigBee: 2405-2480 MHz.
- Potencia máxima radiada : BT: 14,75 mW (11,69 dBm); ZigBee: 14,82 mW (11,71 dBm).
- Restricciones : Estos equipos deben emplear técnicas de compartición de frecuencias.

2. El incumplimiento de lo dispuesto por el presente certificado, será sancionado de acuerdo a las disposiciones legales vigentes. Estos equipos no deberán provocar interferencias a servicios de concesionarias de telecomunicaciones y no estarán protegidos respecto de interferencias que eventualmente puedan recibir.

Saluda atentamente a Ud.,
Por orden del Subsecretario de Telecomunicaciones

DISTRIBUCIÓN:

- MBSERVICES: Laboratorio@mbservices.cl
- Oficina de Partes.

Francisco Javier Pizarro Sepulveda
Jefe División Fiscalización
26/03/2024 17:43





Test report No:
21B0246R-RF-US-P06V01

FCC & ISED TEST REPORT

Product Name	LED Device
Trademark	PHILIPS
Model and /or type reference	9290024227, 9290024228, 9290024229
FCC ID	2AGBW9290024227X(9290024227) 2AGBW9290024228X(9290024228) 2AGBW9290024229X(9290024229)
IC	20812-4227X(9290024227) 20812-4228X(9290024228) 20812-4229X(9290024229)
Applicant's name / address	Signify (China) Investment Co., Ltd. Building no.9, Lane 888, Tianlin Road, Minhang District, Shanghai 200233, China
Test method requested, standard	FCC CFR Title 47 Part 15 Subpart C Section 15.247 ANSI C63.10: 2013 KD558074 D01 15.247 Meas Guidance v05r02 RSS-Gen Issue 5 RSS-247 Issue 2
Verdict Summary	IN COMPLIANCE
Documented by (name / position & signature)	Adma Lu/Project Engineer 
Approved by (name / position & signature)	Jack Zhang/ Supervisor 
Date of issue	2021-12-23
Report template No	Template_FCC 15.247-RF-V1.0

INDEX

	page
General conditions	4
Environmental conditions	4
Possible test case verdicts	5
Abbreviations.....	5
Document History.....	6
Remarks and Comments	6
Used Equipment.....	6
Uncertainty	9
1 General Information	10
1.1 General Description of the Item(s).....	10
1.2 Antenna Information	11
1.3 Channel List.....	12
2 Description of Test Setup.....	13
2.1 Operating mode(s) used for tests	13
2.2 Test Configuration / Block diagram used for tests.....	14
2.3 Testing process	15
3 Verdict summary section.....	16
3.1 Standards	16
3.2 Deviation(s) from the Standard(s) / Test Specification(s).....	16
3.3 Overview of results	17
3.4 Test Facility.....	18
4 Test Results	19
4.1 AC Power Line Conducted Emission.....	19
4.1.1 Limit.....	19
4.1.2 Test Setup	19
4.1.3 Test Procedure	19
4.1.4 Test Data	20
4.2 Emissions in restricted frequency bands	22
4.2.1 Limit.....	22
4.2.2 Test Setup	24
4.2.3 Test Procedure	24
4.2.4 Test Data	25
4.3 Emissions in non-restricted frequency band	33
4.3.1 Limit.....	33

4.3.2	Test Setup	33
4.3.3	Test Procedure	33
4.3.4	Test Data	34
4.4	Duty cycle	36
4.4.1	Limit	36
4.4.2	Test Setup	36
4.4.3	Test Procedure	36
4.4.4	Test Data	37
4.5	Radiated Emission Band Edge	38
4.5.1	Limit	38
4.5.2	Test Setup	38
4.5.3	Test Procedure	38
4.5.4	Test Data	39
4.6	DTS Bandwidth	47
4.6.1	Limit	47
4.6.2	Test Setup	47
4.6.3	Test Procedure	47
4.6.4	Test Data	48
4.7	Fundamental emission output power	49
4.7.1	Limit	49
4.7.2	Test Setup	49
4.7.3	Test Procedure	50
4.7.4	Test Data	51
4.8	Power Density	52
4.8.1	Limit:	52
4.8.2	Test Setup	52
4.8.3	Test Procedure	52
4.8.4	Test Data	53
4.9	Antenna Requirement	54
4.9.1	Limit:	54
4.9.2	Antenna Connector Construction:	54
5	Test setup photo and EUT Photo	55

COMPETENCES AND GUARANTEES

DEKRA is a testing laboratory competent to carry out the tests described in this report.

In order to assure the traceability to other national and international laboratories, DEKRA has a calibration and maintenance program for its measurement equipment.

DEKRA guarantees the reliability of the data presented in this report, which is the result of the measurements and the tests performed to the item under test on the date and under the conditions stated in the report and it is based on the knowledge and technical facilities available at DEKRA at the time of performance of the test.

DEKRA is liable to the client for the maintenance of the confidentiality of all information related to the item under test and the results of the test.

The results presented in this Test Report apply only to the particular item under test established in this document.

IMPORTANT: No parts of this report may be reproduced or quoted out of context, in any form or by any means, except in full, without the previous written permission of DEKRA.

GENERAL CONDITIONS

Test Location	No. 99, Hongye Road, Suzhou Industrial Park Suzhou, 215006, P.R. China
Date(receive sample)	Nov. 08, 2021
Date (start test)	Nov. 09, 2021
Date (finish test)	Nov. 25, 2021

1. This report is only referred to the item that has undergone the test.
2. This report does not constitute or imply on its own an approval of the product by the Certification Bodies or Competent Authorities.
3. This document is only valid if complete; no partial reproduction can be made without previous written permission of DEKRA.
4. This test report cannot be used partially or in full for publicity and/or promotional purposes without previous written permission of DEKRA.

ENVIRONMENTAL CONDITIONS

The climatic conditions during the tests are within the limits specified by the manufacturer for the operation of the EUT and the test equipment. The climatic conditions during the tests were within the following limits:

Ambient temperature	15 °C – 35 °C
Relative Humidity air	30% - 60%

If explicitly required in the basic standard or applied product / product family standard the climatic values are recorded and documented separately in this test report.

POSSIBLE TEST CASE VERDICTS

Test case does not apply to test object	N/A
Test object does meet requirement	P (Pass) / PASS
Test object does not meet requirement	F (Fail) / FAIL
Not measured	N/M

ABBREVIATIONS

For the purposes of the present document, the following abbreviations apply:

EUT	: Equipment Under Test
QP	: Quasi-Peak
CAV	: CISPR Average
AV	: Average
CDN	: Coupling Decoupling Network
SAC	: Semi-Anechoic Chamber
OATS	: Open Area Test Site
BW	: Bandwidth
AM	: Amplitude Modulation
PM	: Pulse Modulation
HCP	: Horizontal Coupling Plane
VCP	: Vertical Coupling Plane
U_N	: Nominal voltage
T_x	: Transmitter
R_x	: Receiver
N/A	: Not Applicable
N/M	: Not Measured

DOCUMENT HISTORY

Report No.	Version	Description	Issued Date
21B0246R-RF-US-P06V01	V1.0	Initial issue of report.	2021-12-23

REMARKS AND COMMENTS

1. The equipment under test (EUT) does meet the essential requirements of the stated standard(s)/test(s).
2. These test results on a sample of the device are for the purpose of demonstrating Compliance with Part 15 Subpart C Paragraph 15.247, RSS-Gen Issue 5, RSS-247 Issue 2.
3. The measurement result is considered in conformance with the requirement if it is within the prescribed limit, It is not necessary to account the uncertainty associated with the measurement result.
4. The test results presented in this report relate only to the object tested.
5. The test report shall not be reproduced without the written approval of DEKRA Testing and Certification (Suzhou) Co., Ltd.
6. This report will not be used for social proof function in China market.
7. DEKRA declines any responsibility with the following test data provided by customer that may affect the validity of result:
 - Chapter 1.1 General Description of the Item(s);
 - Chapter 1.2 Antenna Information;
 - Chapter 1.3 Channel List.

USED EQUIPMENT

AC Power Line Conducted Emission / TR1

Instrument	Manufacturer	Model No.	Serial No.	Cal. Date	Next Cal. Date
EMI Test Receiver	R&S	ESCI	100906	2021.04.28	2022.04.29
Two-Line V-Network	R&S	ENV216	101190	2021.01.27	2022.02.26
Two-Line V-Network	R&S	ENV216	101044	2021.03.20	2022.03.19
Current Probe	R&S	EZ-17	100678	2021.01.27	2022.01.26
50ohm Termination	SHX	TF2	07081403	2021.09.04	2022.09.03
50ohm Coaxial Switch	Anritsu	MP59B	6200464462	N/A	N/A
Temperature/Humidity Meter	RTS	RTS-8S	TR1-TH	2021.07.09	2022.07.08
Coaxial Cable	Suhner	RG 223	TR1-C1	2021.07.09	2022.07.08
Dekra test software	Dekra	-	-	-	-

Emissions in non-restricted frequency bands/ Occupied Bandwidth/ Fundamental emission output power Power Spectral Density / TR8

Instrument	Manufacturer	Model No.	Serial No.	Cal. Date	Next Cal. Date
Spectrum Analyzer	Agilent	N9010A	MY48030494	2021.07.11	2022.07.10
EXA Spectrum Analyzer	Keysight	N9010A	MY55370495	2021.07.11	2022.07.10
MXA Signal Analyzer	Keysight	N9020A	MY56060147	2021.07.11	2022.07.10
Dekra test software	Dekra	-	-	-	-

Radiated Emission(30MHz-1GHz) / AC3

Instrument	Manufacturer	Model No.	Serial No.	Cal. Date	Next Cal. Date
EMI Test Receiver	R&S	ESCI	100573	2021.10.30	2022.10.29
Temperature/Humidity Meter	RTS	RTS-8S	AC2-TH	2021.10.08	2022.10.07
Coaxial Cable	Huber+Suhner	RG 214	AC2-C	2021.03.31	2022.03.30
Dekra test software	Dekra	-	-	-	-

Radiated Emission / AC5(1GHz-40GHz)

Instrument	Manufacturer	Model No.	Serial No.	Cal. Date	Next Cal. Date
Spectrum Analyzer	Agilent	E4446A	MY45300103	2021.05.06	2022.05.05
DRG Horn	ETS-Lindgren	3117	00123988	2021.10.22	2022.10.21
Temperature/Humidity Meter	Zhichen	ZC1-2	AC5-TH	2021.07.09	2022.07.08
Coaxial Cable	Huber+Suhner	SUCOFLEX 106	AC5-C2	2021.03.31	2022.03.30
Dekra test software	Dekra	-	-	-	-

UNCERTAINTY

Uncertainties have been calculated according to the DEKRA internal document. The reported expanded uncertainties are based on a standard uncertainty multiplied by a coverage factor of $k=2$, providing a level of confidence of approximately 95%. The Uncertainties is comply with standard required as below.

Test item	Uncertainty
AC Power Line Conducted Emission	9kHz~150kHz: 2.80 dB 150kHz~30MHz: 2.40 dB
Peak Power Output	± 1.27 dB
Radiated Emission(30MHz~1GHz)	Horizontal: 30MHz~200MHz: 3.50 dB 300MHz~1GHz: 3.60 dB Vertical: 30MHz~200MHz: 3.60 dB 300MHz~1GHz: 3.50 dB
Radiated Emission(1GHz~26.5GHz)	Horizontal: 1GHz~18GHz: 5.00 dB Vertical: 1GHz~18GHz: 4.80 dB
RF antenna conducted test	± 1.27 dB
Radiated Emission Band Edge	± 3.9 dB
DTS Bandwidth	± 150 Hz
Occupied Bandwidth	± 1 kHz
Power Density	± 1.27 dB

1 GENERAL INFORMATION

1.1 General Description of the Item(s)

Product Name	LED Device
Model No.	9290024227, 9290024228, 9290024229
FCC ID	2AGBW9290024227X(9290024227) 2AGBW9290024228X(9290024228) 2AGBW9290024229X(9290024229)
IC	20812-4227X(9290024227) 20812-4228X(9290024228) 20812-4229X(9290024229)
Manufacturer	Signify (China) Investment Co., Ltd.
Manufacturer Address	Building no.9, Lane 888, Tianlin Road, Minhang District, Shanghai 200233, China
Model difference	All models have the same rated power, LED driver, RF module except different model name.

Note: Models 9290024227, 9290024228, 9290024229 only differs on the length of the LED device, three models has been pretested and DEKRA has found that model 9290024227 is the worst case. Test results for Model 9290024227, included in this report, are valid and representative for the three models 9290024227, 9290024228, 9290024229.

Wireless specification	Zigbee
Operating frequency range(s)	2400~2483.5MHz
Type of Modulation	DSSS-OQPSK
Number of channel	16
Date Rate	250kbps

Rated power supply	Voltage and Frequency	
	<input type="checkbox"/>	AC: 220 – 240 V, 50/60 Hz
	<input checked="" type="checkbox"/>	AC: 100-130 Vac; 50/60 Hz;
	<input type="checkbox"/>	DC: 3.2~4.2 Vdc
	<input type="checkbox"/>	Battery:
Mounting position	<input type="checkbox"/>	Table top equipment
	<input checked="" type="checkbox"/>	Wall/Ceiling mounted equipment
	<input type="checkbox"/>	Floor standing equipment
	<input type="checkbox"/>	Head-mounted equipment
	<input type="checkbox"/>	Other: RF module

1.2 Antenna Information

Antenna model / type number	N/A		
Antenna serial number	N/A		
Antenna Delivery	<input checked="" type="checkbox"/>	1TX + 1RX	
	<input type="checkbox"/>	2TX + 2RX	
Antenna technology	<input checked="" type="checkbox"/>	SISO	
	<input type="checkbox"/>	MIMO	<input type="checkbox"/> CDD <input type="checkbox"/> Beam-forming
Antenna Type	<input type="checkbox"/>	External	<input type="checkbox"/> Dipole
			<input type="checkbox"/> Sectorized
	<input checked="" type="checkbox"/>	Internal	<input checked="" type="checkbox"/> PIFA
			<input type="checkbox"/> PCB
			<input type="checkbox"/> Metal Monopole Antenna
		<input type="checkbox"/> Others.....	
Antenna Gain	2.08 dBi		

1.3 Channel List

Working Frequency of Each Channel: For Zigbee							
Channel	Frequency	Channel	Frequency	Channel	Frequency	Channel	Frequency
11	2405 MHz	12	2410 MHz	13	2415 MHz	14	2420 MHz
15	2425 MHz	16	2430 MHz	17	2435 MHz	18	2440 MHz
19	2445 MHz	20	2450 MHz	21	2455 MHz	22	2460 MHz
23	2465 MHz	24	2470 MHz	25	2475 MHz	26	2480 MHz

2 DESCRIPTION OF TEST SETUP

2.1 Operating mode(s) used for tests

During the tests the following operating mode(s) has(have) been used.

Test Mode For Bluetooth	Mode1: Transmit by Zigbee
-------------------------	---------------------------

2.2 Test Configuration / Block diagram used for tests

Test setup Diagram- AC Line Conducted Emission Test

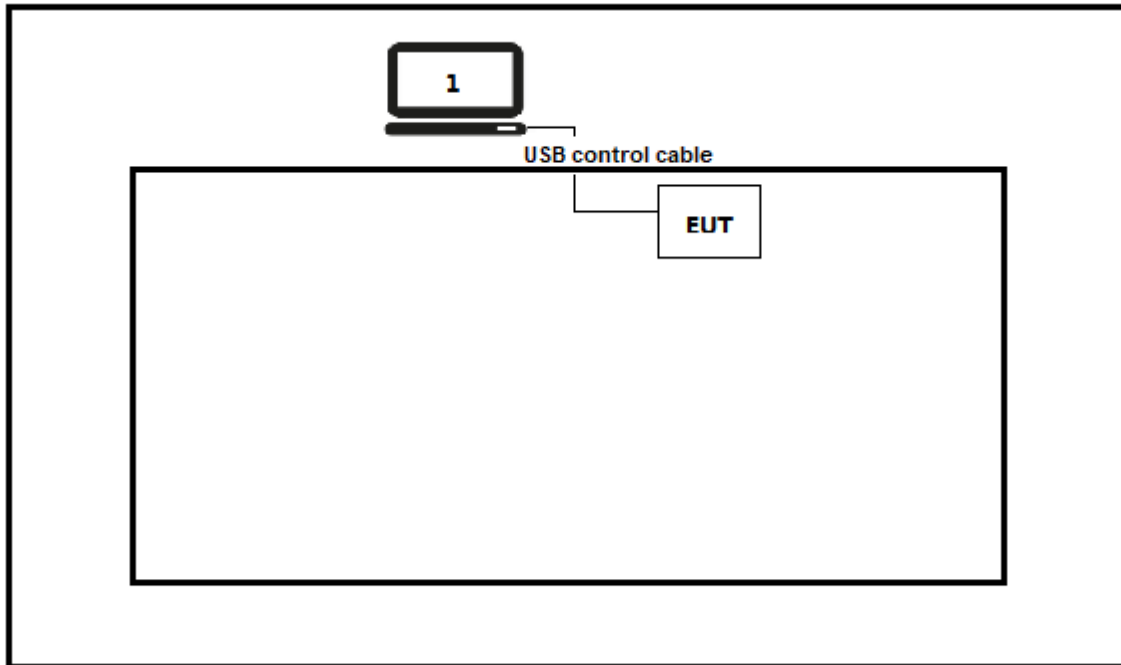

Test setup Diagram- Radiated Emission

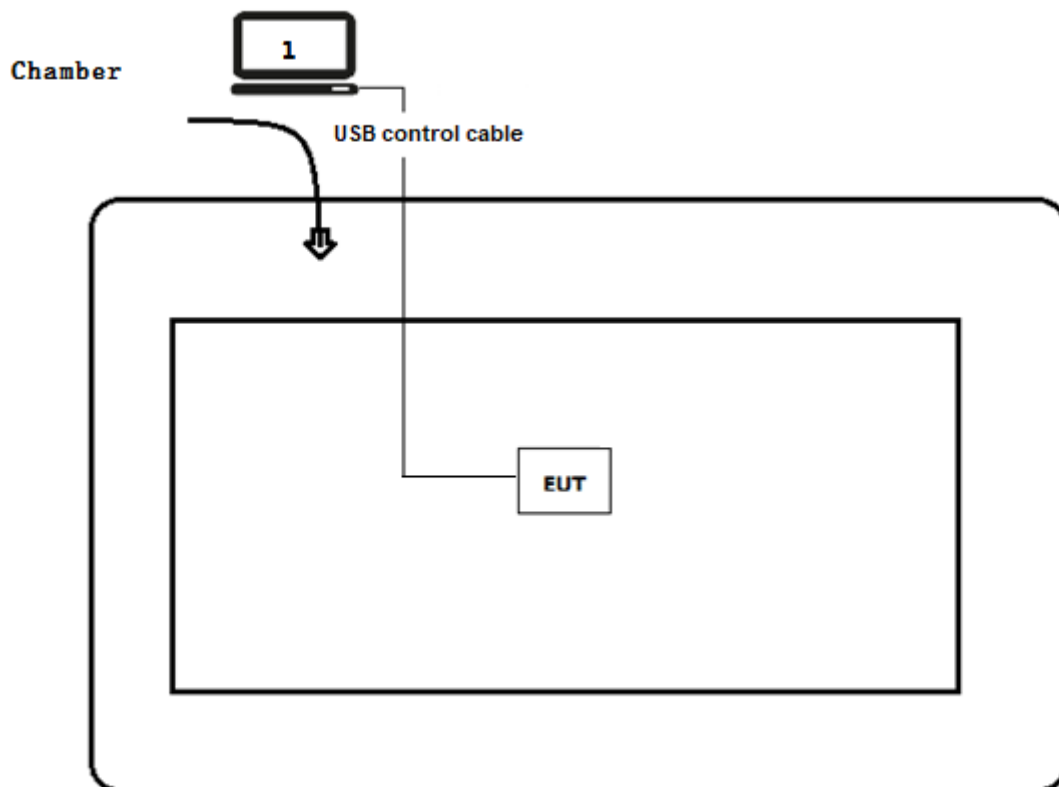

2.3 Testing process

1	Setup the EUT as shown in Section 2.2.
2	Execute Switch channel by repeating power on.
3	Configure the test mode, the test channel, and the data rate.
4	Verify that the EUT works properly.

3 VERDICT SUMMARY SECTION

This chapter presents an overview of standards and results. Refer to the next chapters for details of measured test results and applied test levels.

3.1 Standards

Standard	Year	Description
FCC CFR Title 47 Part 15 Subpart C Section 15.247	2019	Operation within the bands 902–928 MHz, 2400–2483.5 MHz, and 5725–5850 MHz.
ANSI C63.10	2013	American National Standard of Procedures for Compliance Testing of Unlicensed Wireless Devices
KDB 558074 D01 v05r02	2019	Guidance for performing compliance measurements on Digital Transmission System (DTS) operating under section 15.247
RSS-Gen Issue 5 Amendment 1	2019	General Requirements for Compliance of Radio Apparatus
RSS-247 Issue 2	2017	Digital Transmission Systems (DTSs), Frequency Hopping Systems (FHSs) and Licence-Exempt Local Area Network (LE-LAN) Devices

3.2 Deviation(s) from the Standard(s) / Test Specification(s)

The following deviation(s) was / were made from the published requirements of the listed standards: N/A.

(Please define the deviations from the standard(s) if applicable)

3.3 Overview of results

For FCC

Requirement – Test case	Basic standard(s)	Verdict	Remark
AC Power Line Conducted Emission	FCC 15.207	PASS	---
Emissions in restricted frequency bands	FCC 15.247(b)(3)	PASS	---
Duty cycle	ANSI C63.10:2013	PASS	---
Emissions in non-restricted frequency bands	FCC 15.247(d), FCC 15.209	PASS	---
Radiated Emission Band Edge	FCC 15.247(d)	PASS	---
Fundamental emission output power	FCC 15.247(d), FCC 15.209	PASS	---
DTS Bandwidth	FCC 15.247(a)(2)	PASS	---
Power Spectral Density	FCC 15.247(e)	PASS	---
Antenna Requirement	FCC 15.203	PASS	---

For ISED

Requirement – Test case	Basic standard(s)	Verdict	Remark
AC Power Line Conducted Emission	RSS-Gen Issue 5 Section 8.8	PASS	---
Emissions in restricted frequency bands	RSS-Gen Issue 5 Section 8.9	PASS	---
Duty cycle	ANSI C63.10:2013	PASS	---
Emissions in non-restricted frequency bands	RSS-247 Issue 2 Section 5.5	PASS	---
Radiated Emission Band Edge	RSS-Gen Issue 5 Section 8.10	PASS	---
Fundamental emission output power	RSS-247 Issue 2 Section 5.4(d)	PASS	---
DTS Bandwidth	RSS-Gen Issue 5 Section 6.7	PASS	---
Power Spectral Density	RSS-247 Issue 2 Section 5.2(b)	PASS	---
Antenna Requirement	RSS-Gen Issue 5 Section 6.8	PASS	---

3.4 Test Facility

USA : **FCC Designation Number: CN1199**

CA : **ISED CAB identifier: CN0040**

4 TEST RESULTS

4.1 AC Power Line Conducted Emission

VERDICT: PASS

4.1.1 Limit

Standard		
FCC Part 15 Subpart C Paragraph 15.207		
Frequency range [MHz]	Limit: QP [dB(μV) ¹⁾	Limit: AV [dB(μV) ¹⁾
0,15 - 0,50	66 - 56 ²⁾	56 - 46 ²⁾
0,50 - 5,0	56	46
5,0 - 30	60	50

¹⁾ At the transition frequency, the lower limit applies.

²⁾ The limit decreases linearly with the logarithm of the frequency.

NOTE 1: The exclusion band for transmitters shall be considered for transmitters operating at frequencies below 30 MHz.

NOTE 2: Where the AC output port is directly connected (or via a circuit breaker) to the AC power input port of the EUT the AC power output port need not to be tested.

4.1.2 Test Setup

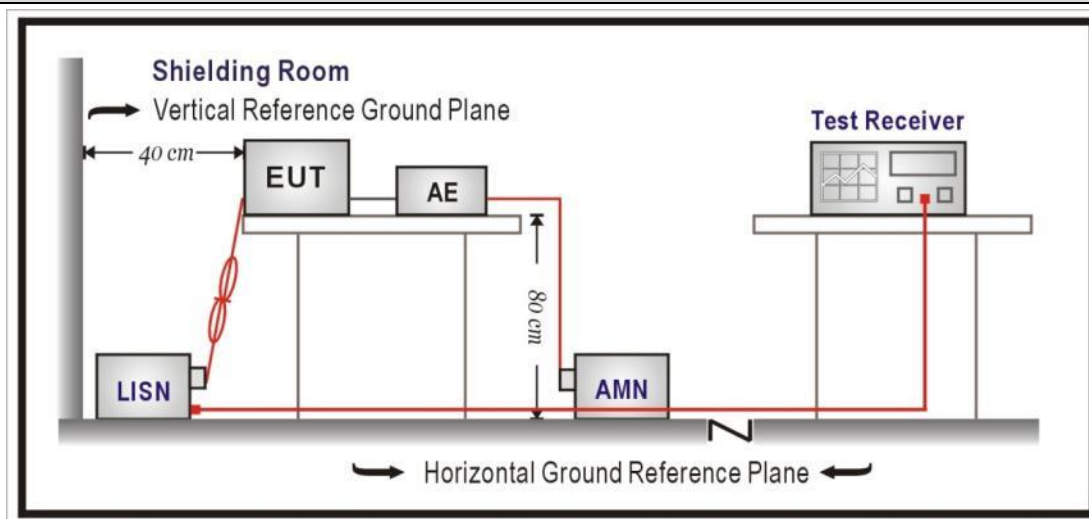

4.1.3 Test Procedure

References Rule	Chapter	Item
<input checked="" type="checkbox"/> ANSI C63.10-2013	6.2	Standard test method for ac power-line conducted emissions from unlicensed wireless devices

4.1.4 Test Data

Profile: 21B0246R	Page No.: 21
Engineer: Neil	
Site: TR1	Time: 2021/11/25
Limit: FCC_Part15.107_CE_AC Power_ClassB	Margin: 0
Probe: ENV216_101189(0.009-30MHz)	Polarity: Line
EUT: LED Device	Power: AC 120V/60Hz
Note: Modle1	

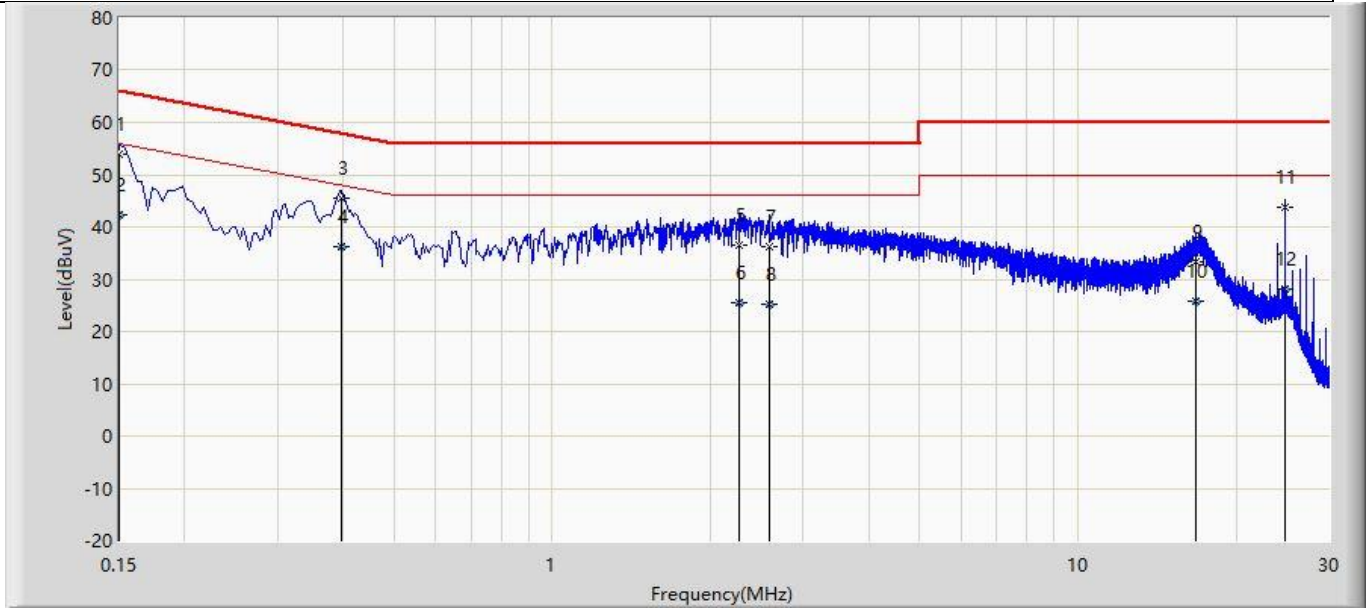

No	Mark	Frequency (MHz)	Measure Level (dBuV)	Reading Level (dBuV)	Over Limit (dB)	Limit (dBuV)	Probe (dB)	Cable (dB)	Amp (dB)	Type
1		0.150	54.036	44.370	-11.964	66.000	9.641	0.025	0.000	QP
2		0.150	42.431	32.764	-13.569	56.000	9.641	0.025	0.000	AV
3		0.398	45.373	35.691	-12.522	57.895	9.643	0.039	0.000	QP
4	*	0.398	36.188	26.507	-11.707	47.895	9.643	0.039	0.000	AV
5		2.262	36.642	26.904	-19.358	56.000	9.644	0.094	0.000	QP
6		2.262	25.448	15.711	-20.552	46.000	9.644	0.094	0.000	AV
7		2.582	36.209	26.457	-19.791	56.000	9.650	0.102	0.000	QP
8		2.582	25.222	15.471	-20.778	46.000	9.650	0.102	0.000	AV
9		16.754	33.329	23.152	-26.671	60.000	9.915	0.261	0.000	QP
10		16.754	25.721	15.545	-24.279	50.000	9.915	0.261	0.000	AV
11		24.802	43.653	33.188	-16.347	60.000	10.144	0.320	0.000	QP
12		24.802	28.096	17.632	-21.904	50.000	10.144	0.320	0.000	AV

Note:

1. " * ", means this data is the worst emission level.
2. Measurement Level = Reading Level + Factor(Probe+Cable-Amp).

Profile: 21B0246R	Page No.: 22
Engineer: Neil	
Site: TR1	Time: 2021/11/25
Limit: FCC_Part15.107_CE_AC Power_ClassB	Margin: 0
Probe: ENV216_101189(0.009-30MHz)	Polarity: Neutral
EUT: LED Device	Power: AC 120V/60Hz
Note: Modle1	

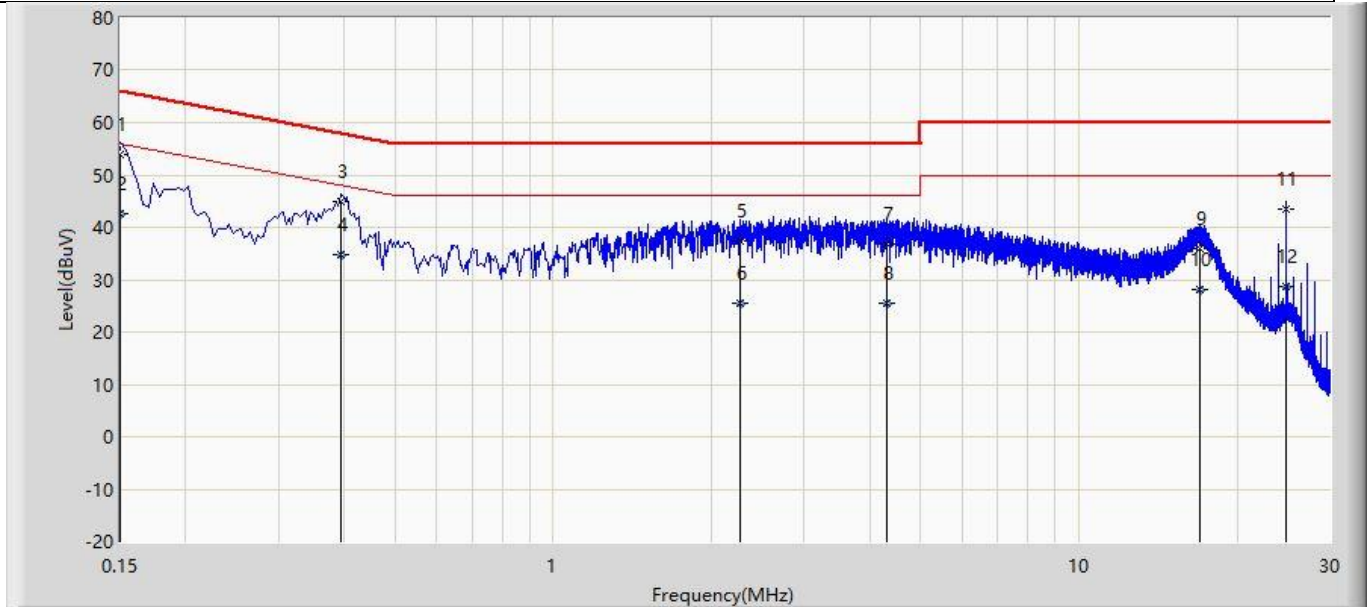

No	Mark	Frequency (MHz)	Measure Level (dBuV)	Reading Level (dBuV)	Over Limit (dB)	Limit (dBuV)	Probe (dB)	Cable (dB)	Amp (dB)	Type
1	*	0.150	53.992	44.337	-12.008	66.000	9.630	0.025	0.000	QP
2		0.150	42.504	32.849	-13.496	56.000	9.630	0.025	0.000	AV
3		0.394	44.844	35.186	-13.135	57.979	9.620	0.039	0.000	QP
4		0.394	34.646	24.987	-13.333	47.979	9.620	0.039	0.000	AV
5		2.266	37.472	27.744	-18.528	56.000	9.634	0.094	0.000	QP
6		2.266	25.488	15.760	-20.512	46.000	9.634	0.094	0.000	AV
7		4.314	36.746	26.946	-19.254	56.000	9.669	0.132	0.000	QP
8		4.314	25.602	15.801	-20.398	46.000	9.669	0.132	0.000	AV
9		16.974	35.905	25.752	-24.095	60.000	9.890	0.263	0.000	QP
10		16.974	28.195	18.042	-21.805	50.000	9.890	0.263	0.000	AV
11		24.798	43.378	32.897	-16.622	60.000	10.160	0.320	0.000	QP
12		24.798	28.659	18.178	-21.341	50.000	10.160	0.320	0.000	AV

Note:

1. " * ", means this data is the worst emission level.
2. Measurement Level = Reading Level + Factor(Probe+Cable-Amp).

4.2 Emissions in restricted frequency bands	VERDICT: PASS
--	----------------------

4.2.1 Limit			
Standard		FCC Part 15 Subpart C Paragraph 15.209	
Restricted Bands of operation			
Frequency (MHz)	Frequency (MHz)	Frequency (MHz)	Frequency (GHz)
0.090 – 0.110	16.42 – 16.423	399.9 – 410	4.5 – 5.15
0.495 – 0.505	16.69475 – 16.69525	608 – 614	5.35 – 5.46
2.1735 – 2.1905	16.80425 – 16.80475	960 – 1240	7.25 – 7.75
4.125 – 4.128	25.5 – 25.67	1300 – 1427	8.025 – 8.5
4.17725 – 4.17775	37.5 – 38.25	1435 – 1626.5	9.0 – 9.2
4.20725 – 4.20775	73 – 74.6	1645.5 – 1646.5	9.3 – 9.5
6.215 – 6.218	74.8 – 75.2	1660 – 1710	10.6 – 12.7
6.26775 – 6.26825	108 – 121.94	1718.8 – 1722.2	13.25 – 13.4
6.31175 – 6.31225	123 – 138	2200 – 2300	14.47 – 14.5
8.291 – 8.294	149.9 – 150.05	2310 – 2390	15.35 – 16.2
8.362 – 8.366	156.52475 – 156.52525	2483.5 – 2500	17.7 – 21.4
8.37625 – 8.38675	156.7 – 156.9	2690 – 2900	22.01 – 23.12
8.81425 – 8.81475	162.0125 – 167.17	3260 – 3267	23.6 – 24.0
12.29 – 12.293	167.72 – 173.2	3332 – 3339	31.2 – 31.8
12.51975 – 12.52025	240 – 285	3345.8 – 3358	36.43 – 36.5
12.57675 – 12.57725	322 – 335.4	3600 – 4400	
13.36 – 13.41			
Restricted Bands of operation for IC			
0.090 - 0.110	13.36 - 13.41	960 - 1427	9.0 - 9.2
0.495 - 0.505	16.42 - 16.423	1435 - 1626.5	9.3 - 9.5
2.1735 - 2.1905	16.69475 - 16.69525	1645.5 - 1646.5	10.6 - 12.7
3.020 - 3.026	16.80425 - 16.80475	1660 - 1710	13.25 - 13.4
4.125 - 4.128	25.5 - 25.67	1718.8 - 1722.2	14.47 - 14.5
4.17725 - 4.17775	37.5 - 38.25	2200 - 2300	15.35 - 16.2
4.20725 - 4.20775	73 - 74.6	2310 - 2390	17.7 - 21.4
5.677 - 5.683	74.8 - 75.2	2483.5 - 2500	22.01 - 23.12
6.215 - 6.218	108 - 138	2655 - 2900	23.6 - 24.0
6.26775 - 6.26825	149.9 - 150.05	3260 - 3267	31.2 - 31.8
6.31175 - 6.31225	156.52475 - 156.52525	3332 - 3339	36.43 - 36.5
8.291 - 8.294	156.7 - 156.9	3345.8 - 3358	Above 38.6
8.362 - 8.366	162.0125 - 167.17	3500 - 4400	
8.37625 - 8.38675	167.72 - 173.2	4500 - 5150	
8.81425 - 8.81475	240 - 285	5350 - 5460	
12.29 - 12.293	322 - 335.4	7250 - 7750	
12.51975 - 12.52025	399.9 - 410	8025 - 8500	
12.57675 - 12.57725	608 - 614	--	

Restricted Band Emissions Limit			
Frequency (MHz)	Field strength ($\mu\text{V/m}$)	Field strength ($\text{dB}\mu\text{V/m}$)	Measurement distance (m)
0.009 - 0.49	2400/F(kHz)	48.5 – 13.8	300 _(Note 1)
0.49 - 1.705	24000/F(kHz)	33.8 - 23	30 _(Note 1)
1.705 - 30	30	29.5	30 _(Note 1)
30 - 88	100	40	3 _(Note 2)
88 - 216	150	43.5	3 _(Note 2)
216 - 960	200	46	3 _(Note 2)
Above 960	500	54	3 _(Note 2)

Note 1: At frequencies below 30 MHz, measurements may be performed at a distance closer than that specified in the regulations; however, an attempt should be made to avoid making measurements in the near field. Pending the development of an appropriate measurement procedure for measurements performed below 30 MHz, when performing measurements at a closer distance than specified, the results shall be extrapolated to the specified distance by either making measurements at a minimum of two distances on at least one radial to determine the proper extrapolation factor or by using the square of an inverse linear distance extrapolation factor (40 dB/decade).

Note 2: At frequencies at or above 30 MHz, measurements may be performed at a distance other than what is specified provided: measurements are not made in the near field except where it can be shown that near field measurements are appropriate due to the characteristics of the device; and it can be demonstrated that the signal levels needed to be measured at the distance employed can be detected by the measurement equipment.

Measurements shall not be performed at a distance greater than 30 meters unless it can be further demonstrated that measurements at a distance of 30 meters or less are impractical. When performing measurements at a distance other than that specified, the results shall be extrapolated to the specified distance using an extrapolation factor of 20 dB/decade (inverse linear-distance for field strength measurements; inverse-linear-distance-squared for power density measurements).

4.2.2 Test Setup

30MHz-1GHz Test Setup:

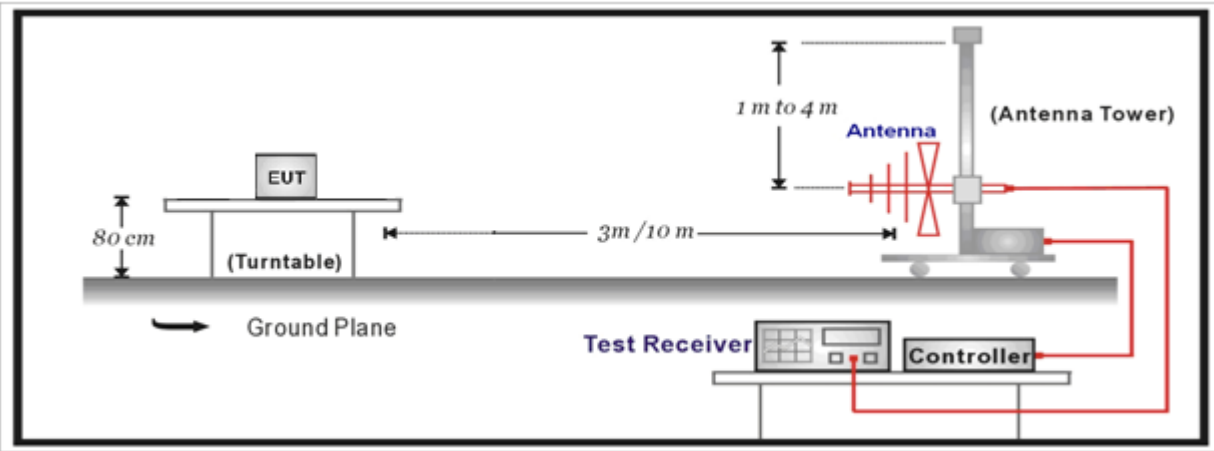

Above 1GHz Test Setup:

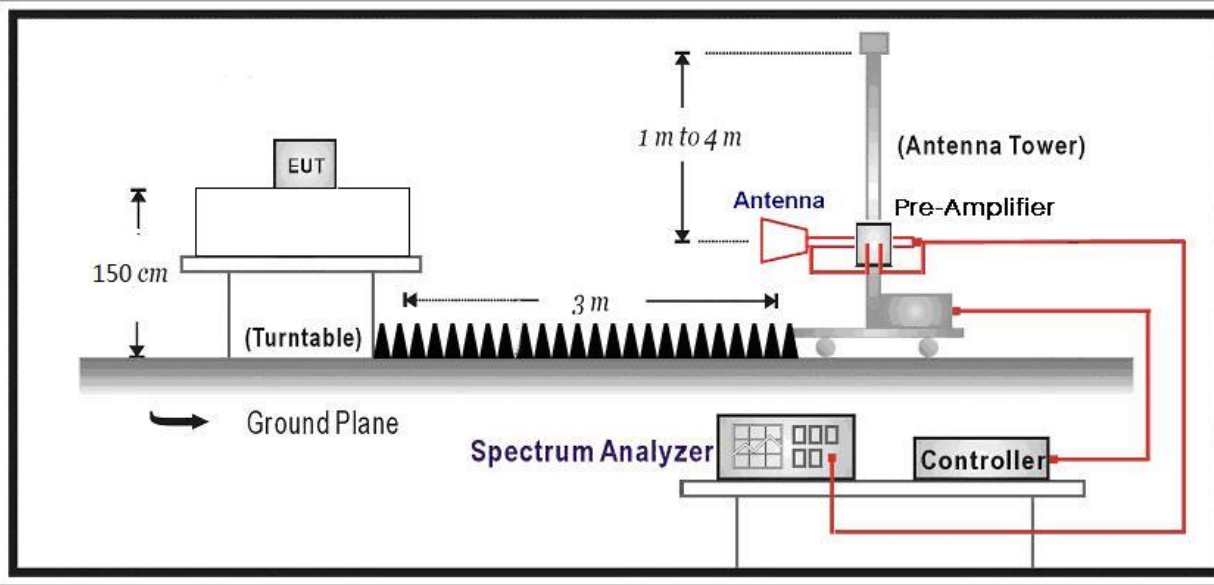

4.2.3 Test Procedure

References Rule	Chapter	Description
<input checked="" type="checkbox"/> ANSI C63.10	11.12	Emissions in restricted frequency bands
<input checked="" type="checkbox"/> ANSI C63.10	11.12.1	Radiated emission measurements
<input checked="" type="checkbox"/> ANSI C63.10	11.12.2.7	Radiated spurious emission test
<input checked="" type="checkbox"/> ANSI C63.10	6.4	Radiated emissions from unlicensed wireless devices below 30 MHz
<input checked="" type="checkbox"/> ANSI C63.10	6.5	Radiated emissions from unlicensed wireless devices in the frequency range of 30 MHz to 1000 MHz
<input checked="" type="checkbox"/> ANSI C63.10	6.6	Radiated emissions from unlicensed wireless devices above 1 GHz

4.2.4 Test Data

Profile: 21B0246R	Page No.: 55
Engineer: Neil	
Site: AC5	Time: 2021/11/11 - 21:01
Limit: FCC_Part15.209_RE(3m)	Margin: 0
Probe: Horn_3117_00123988_(1-18GHz)	Polarity: Horizontal
EUT: LED Device	Power: AC 120V/60Hz
Note: Mode 1: Transmit at 2405MHz by Zigbee	

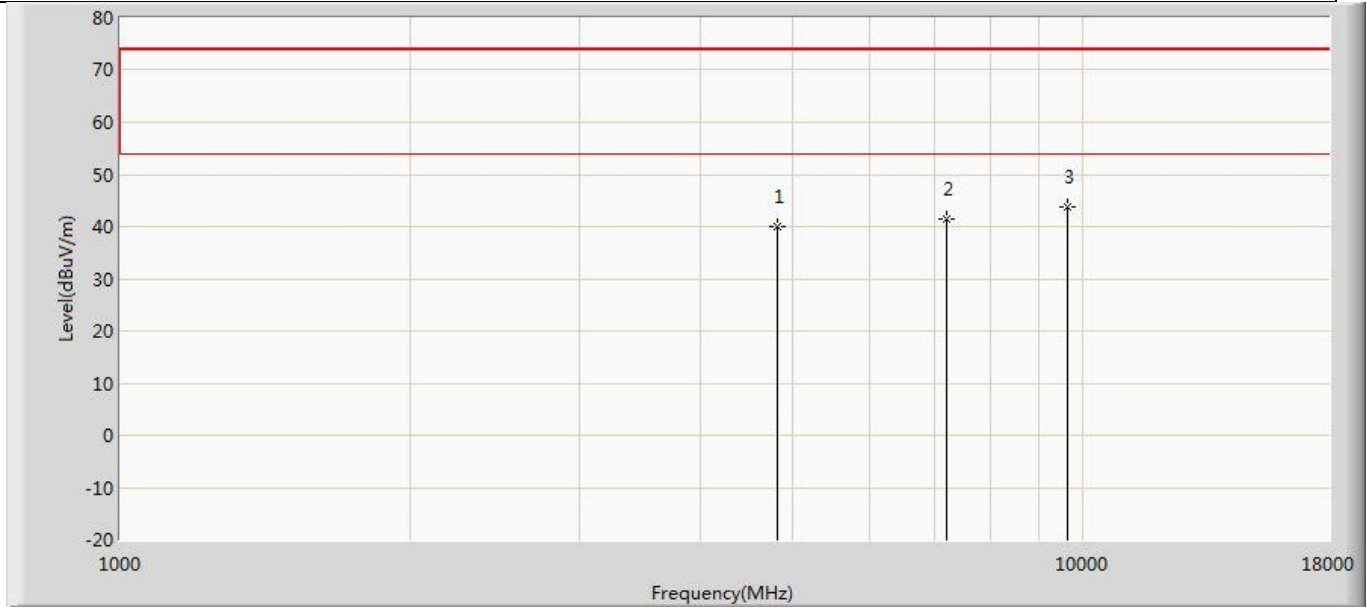

No	Mark	Frequency (MHz)	Measure Level (dBuV/m)	Reading Level (dBuV)	Over Limit (dB)	Limit (dBuV/m)	Factor (dB)	Type
1		4810.000	39.890	34.254	-34.110	74.000	5.636	PK
2		7215.000	41.309	32.089	-32.691	74.000	9.220	PK
3	*	9620.000	43.662	30.496	-30.338	74.000	13.166	PK

Profile: 21B0246R	Page No.: 56
Engineer: Neil	
Site: AC5	Time: 2021/11/11 - 21:01
Limit: FCC_Part15.209_RE(3m)	Margin: 0
Probe: Horn_3117_00123988_(1-18GHz)	Polarity: Vertical
EUT: LED Device	Power: AC 120V/60Hz
Note: Mode 1:Transmit at 2405MHz by Zigbee	

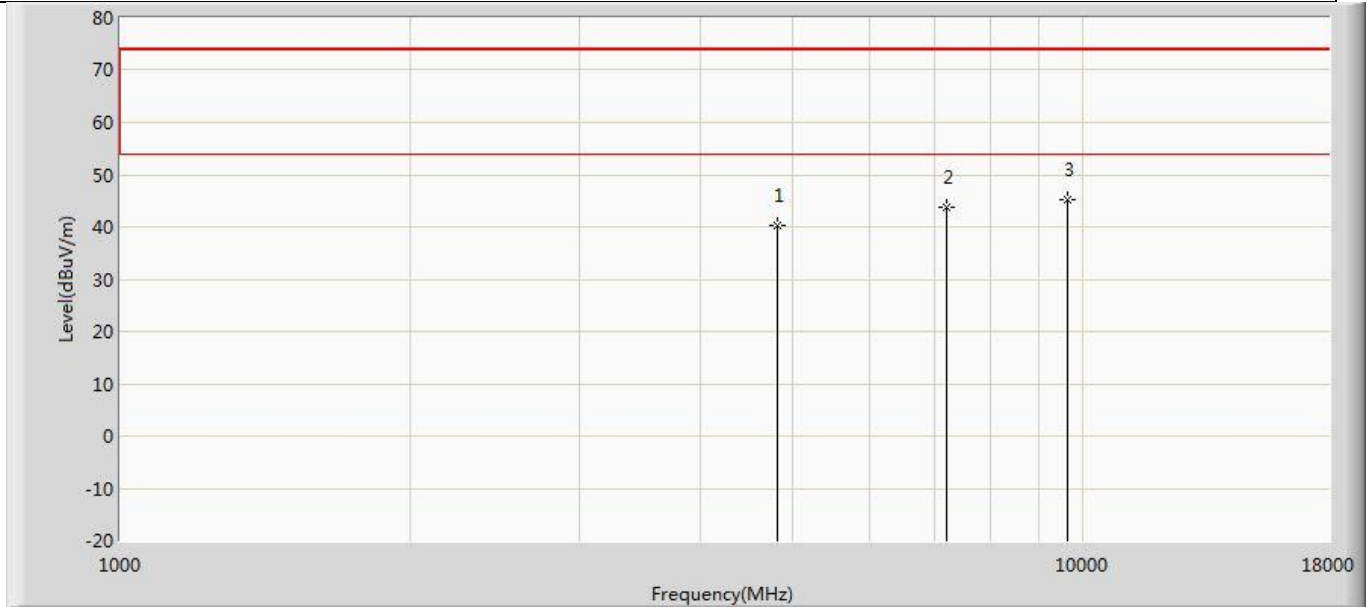

No	Mark	Frequency (MHz)	Measure Level (dBuV/m)	Reading Level (dBuV)	Over Limit (dB)	Limit (dBuV/m)	Factor (dB)	Type
1		4810.000	40.227	34.591	-33.773	74.000	5.636	PK
2		7215.000	43.725	34.505	-30.275	74.000	9.220	PK
3	*	9620.000	45.096	31.930	-28.904	74.000	13.166	PK

Profile: 21B0246R	Page No.: 57
Engineer: Neil	
Site: AC5	Time: 2021/11/11 - 21:01
Limit: FCC_Part15.209_RE(3m)	Margin: 0
Probe: Horn_3117_00123988_(1-18GHz)	Polarity: Horizontal
EUT: LED Device	Power: AC 120V/60Hz
Note: Mode 1:Transmit at 2440MHz by Zigbee	

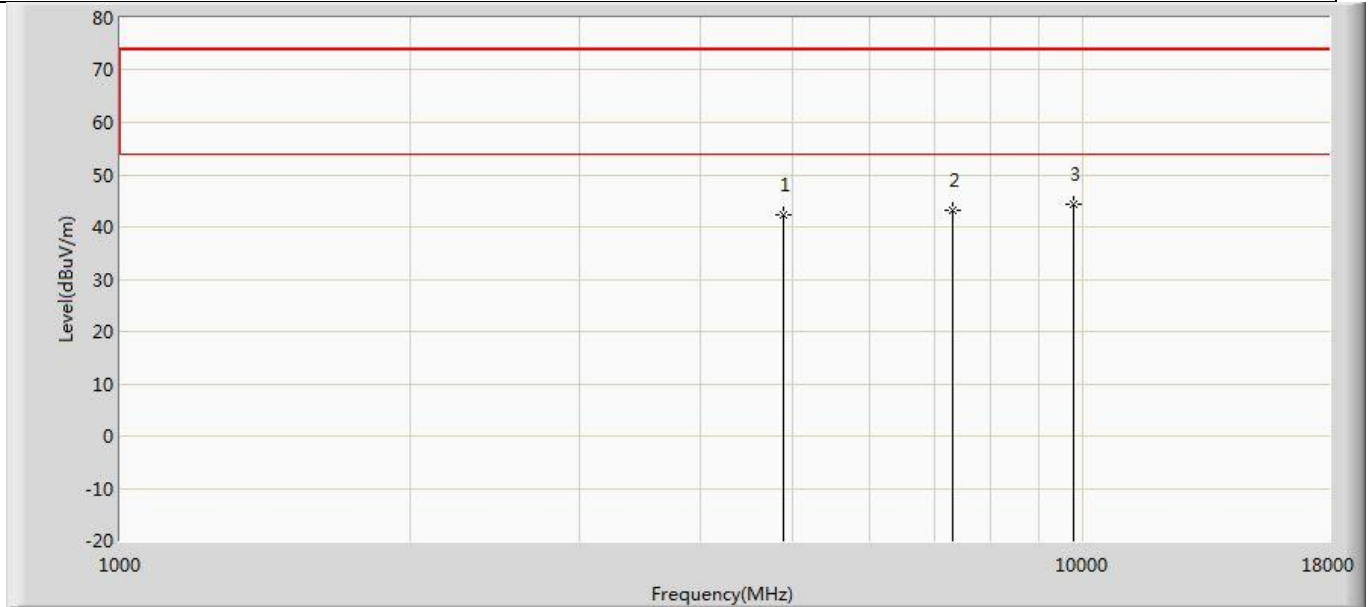

No	Mark	Frequency (MHz)	Measure Level (dBuV/m)	Reading Level (dBuV)	Over Limit (dB)	Limit (dBuV/m)	Factor (dB)	Type
1		4880.000	42.394	36.475	-31.606	74.000	5.919	PK
2		7320.000	43.191	33.685	-30.809	74.000	9.506	PK
3	*	9760.000	44.330	31.276	-29.670	74.000	13.054	PK

Profile: 21B0246R	Page No.: 58
Engineer: Neil	
Site: AC5	Time: 2021/11/11 - 21:01
Limit: FCC_Part15.209_RE(3m)	Margin: 0
Probe: Horn_3117_00123988_(1-18GHz)	Polarity: Vertical
EUT: LED Device	Power: AC 120V/60Hz
Note: Mode 1:Transmit at 2440MHz by Zigbee	

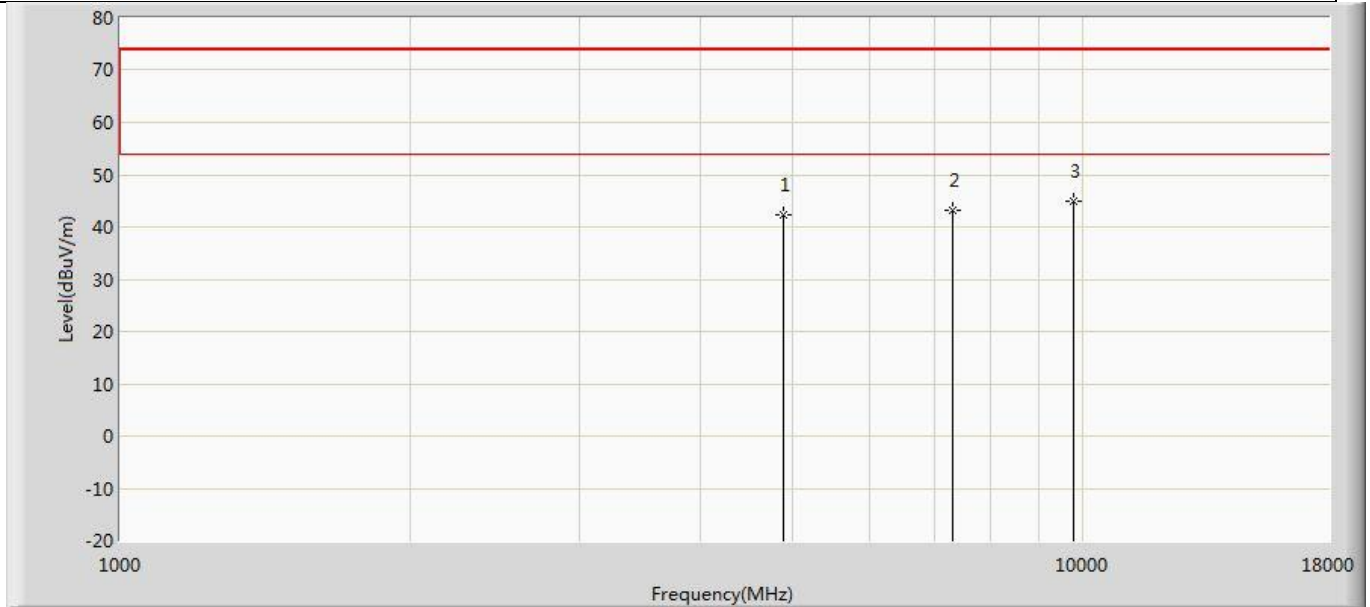

No	Mark	Frequency (MHz)	Measure Level (dBuV/m)	Reading Level (dBuV)	Over Limit (dB)	Limit (dBuV/m)	Factor (dB)	Type
1		4880.000	42.236	36.317	-31.764	74.000	5.919	PK
2		7320.000	43.279	33.773	-30.721	74.000	9.506	PK
3	*	9760.000	45.028	31.974	-28.972	74.000	13.054	PK

Profile: 21B0246R	Page No.: 59
Engineer: Neil	
Site: AC5	Time: 2021/11/11 - 21:01
Limit: FCC_Part15.209_RE(3m)	Margin: 0
Probe: Horn_3117_00123988_(1-18GHz)	Polarity: Horizontal
EUT: LED Device	Power: AC 120V/60Hz
Note: Mode 1:Transmit at 2480MHz by Zigbee	

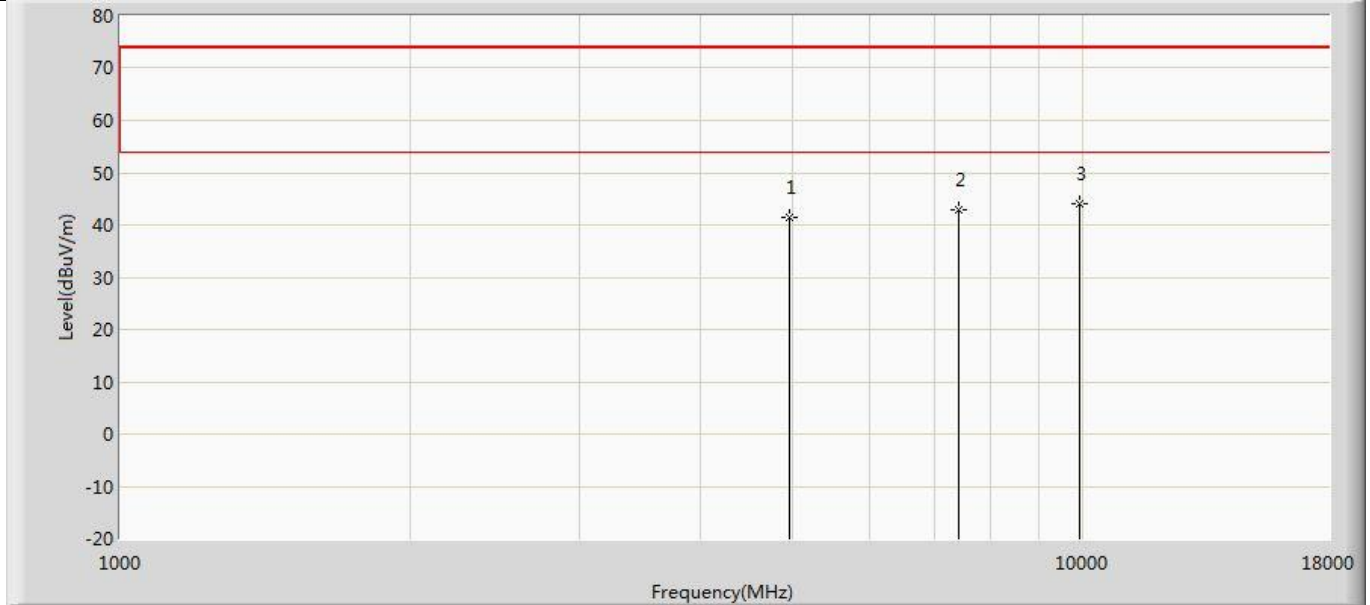

No	Mark	Frequency (MHz)	Measure Level (dBuV/m)	Reading Level (dBuV)	Over Limit (dB)	Limit (dBuV/m)	Factor (dB)	Type
1		4960.000	41.386	35.408	-32.614	74.000	5.978	PK
2		7440.000	42.921	33.394	-31.079	74.000	9.526	PK
3	*	9920.000	44.037	31.050	-29.963	74.000	12.986	PK

Profile: 21B0246R	Page No.: 60
Engineer: Neil	
Site: AC5	Time: 2021/11/11 - 21:01
Limit: FCC_Part15.209_RE(3m)	Margin: 0
Probe: Horn_3117_00123988_(1-18GHz)	Polarity: Vertical
EUT: LED Device	Power: AC 120V/60Hz
Note: Mode 1:Transmit at 2480MHz by Zigbee	

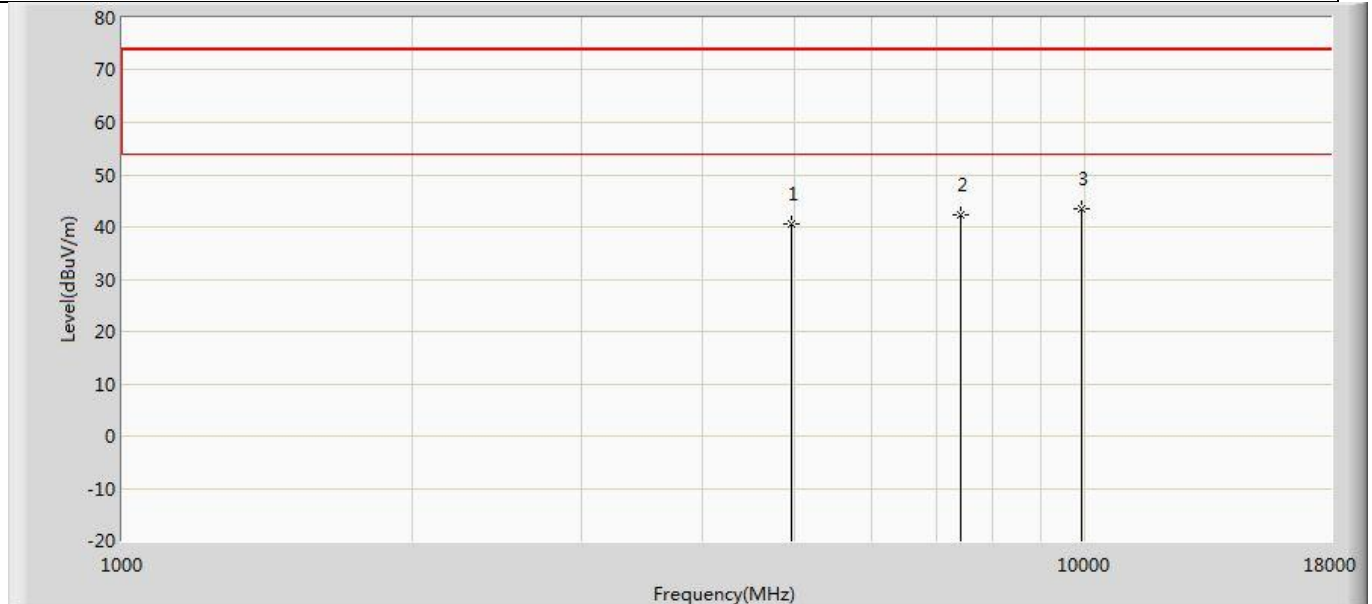

No	Mark	Frequency (MHz)	Measure Level (dBuV/m)	Reading Level (dBuV)	Over Limit (dB)	Limit (dBuV/m)	Factor (dB)	Type
1		4960.000	40.443	34.465	-33.557	74.000	5.978	PK
2		7440.000	42.230	32.703	-31.770	74.000	9.526	PK
3	*	9920.000	43.448	30.461	-30.552	74.000	12.986	PK

Note:

1. Measured Level = Reading Level + Factor.
2. The test frequency range, 9kHz~30MHz, 18GHz~26GHz, both of the worst case are at least 20dB below the limits, therefore no data appear in the report.
3. This limit applies for using average detector, if the test result on peak is lower than average limit, then average measurement needn't be performed.
4. As the radiated emission was performed, so conducted emission was not tested.

The worst case of Radiated Emission below 1GHz:

Profile: 21B0246R	Page No.: 3
Engineer: Neil	
Site: AC2	Time: 2021/11/26 - 03:05
Limit: ICES-003_RE(3m)_ClassB	Margin: 4
Probe: AC2_3M(30-1000M)	Polarity: Vertical
EUT: LED DEVICE	Power: AC 120V/60Hz
Note: Modle1	

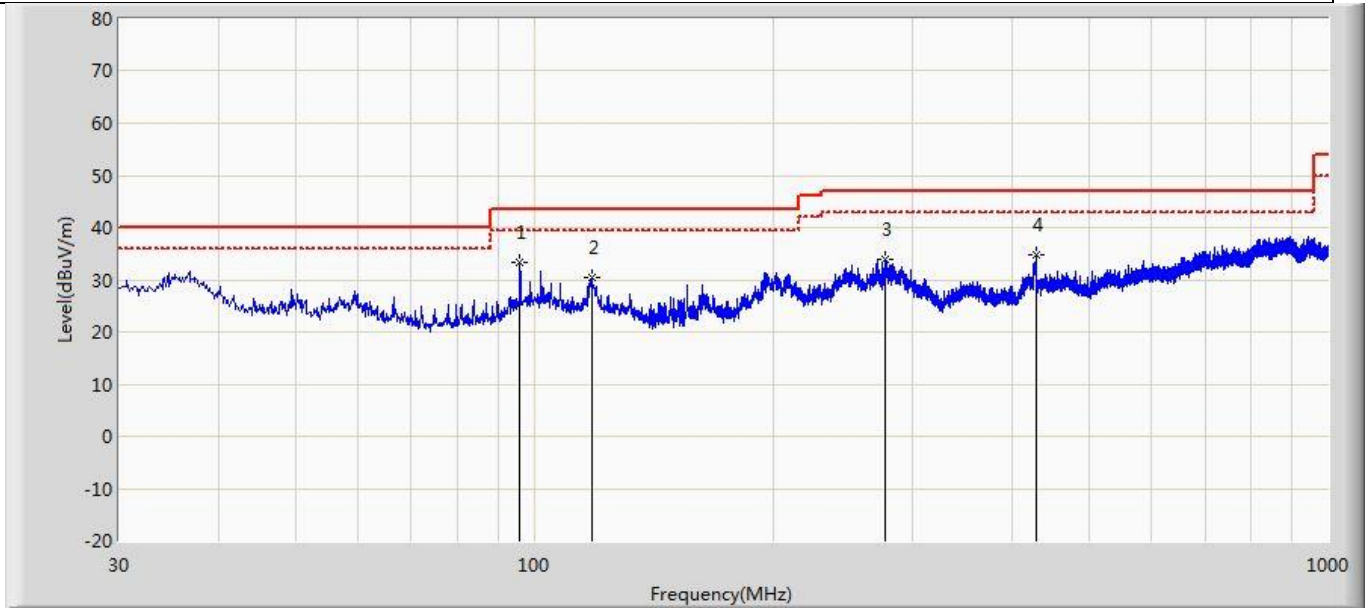

No	Mark	Frequency (MHz)	Measure Level (dBuV/m)	Reading Level (dBuV)	Over Limit (dB)	Limit (dBuV/m)	Factor (dB)	Type
1	*	95.960	33.272	13.106	-10.228	43.500	20.166	PK
2		118.270	30.344	9.821	-13.156	43.500	20.523	PK
3		276.501	33.843	9.574	-13.157	47.000	24.269	PK
4		428.306	34.702	8.860	-12.298	47.000	25.842	PK

Profile: 21B0246R	Page No.: 4
Engineer: Neil	
Site: AC2	Time: 2021/11/26 - 03:15
Limit: ICES-003_RE(3m)_ClassB	Margin: 4
Probe: AC2_3M(30-1000M)	Polarity: Horizontal
EUT: LED DEVICE	Power: AC 120V/60Hz
Note: Modle1	

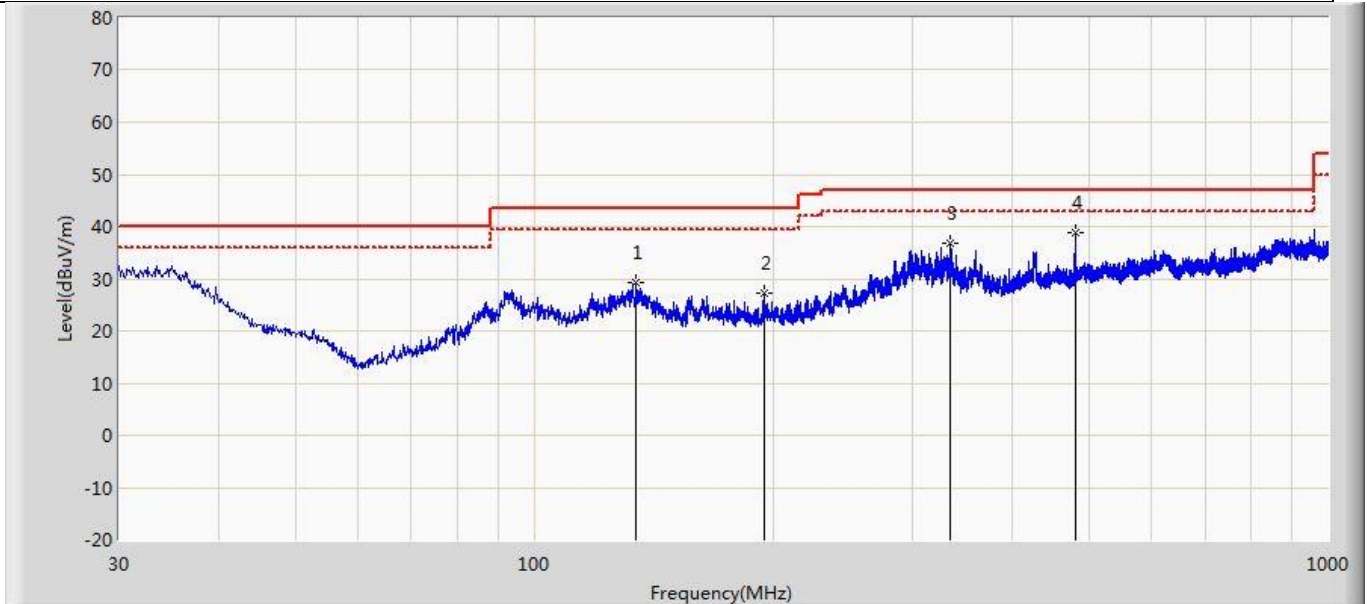

No	Mark	Frequency (MHz)	Measure Level (dBuV/m)	Reading Level (dBuV)	Over Limit (dB)	Limit (dBuV/m)	Factor (dB)	Type
1		134.275	29.332	11.586	-14.168	43.500	17.746	PK
2		195.143	27.162	9.699	-16.338	43.500	17.462	PK
3		334.337	36.924	14.080	-10.076	47.000	22.844	PK
4	*	479.959	38.740	11.720	-8.260	47.000	27.019	PK

4.3 Emissions in non-restricted frequency band	VERDICT: PASS
---	----------------------

4.3.1 Limit	
Standard	FCC Part 15 Subpart C Paragraph 15.247(d)
RF Output power (Detection methods)	Limit(dB)
RF Output power(Average detector)	30dBc(Note1)
RF Output power(PK detector)	20dBc(Note2)
<p>Note 1: If maximum conducted (average) output power was used to demonstrate compliance as described in 9.2, then the peak power in any 100 kHz bandwidth outside of the authorized frequency band shall be attenuated by at least 30 dB relative to the maximum in-band peak PSD level in 100 kHz (i.e., 30 dBc).</p> <p>Note 2: If the maximum peak conducted output power procedure was used, then the peak output power measured in any 100 kHz bandwidth outside of the authorized frequency band shall be attenuated by at least 20 dB relative to the maximum in-band peak PSD level in 100 kHz (i.e., 20 dBc).</p>	

4.3.2 Test Setup

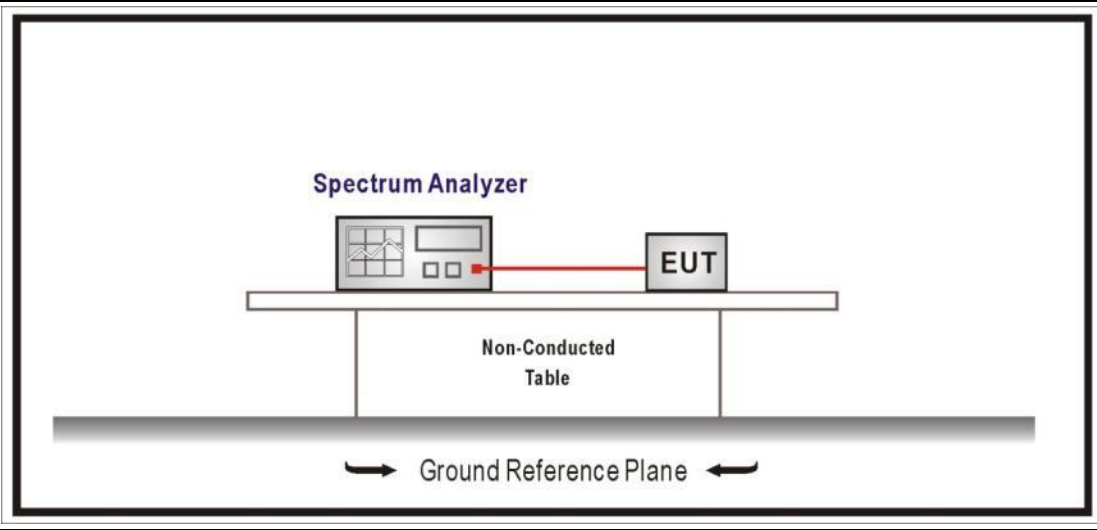

4.3.3 Test Procedure

References Rule	Chapter	Description
<input checked="" type="checkbox"/> ANSI C63.10	11.11	Emissions in non-restricted frequency bands
<input checked="" type="checkbox"/> ANSI C63.10	11.11.1	General
<input checked="" type="checkbox"/> ANSI C63.10	11.11.2	Reference level measurement
<input checked="" type="checkbox"/> ANSI C63.10	11.11.3	Emission level measurement

4.3.4 Test Data

Mode	Channel	Test Frequency (MHz)	Maximum In-Band PSD[a] (dBm/100kHz)	Frequency (MHz)	Out-Band PSD[b] (dBm/100kHz)	[a]-[b] (dB)	Limit (dB)	Result
1	11	2405	5.596	2400	-45.903	51.499	>20	Pass
	26	2480	5.543	2500	-54.122	59.665	>20	Pass

Note 1: The worst data plot as below:

Mode1/CH11/2405MHz

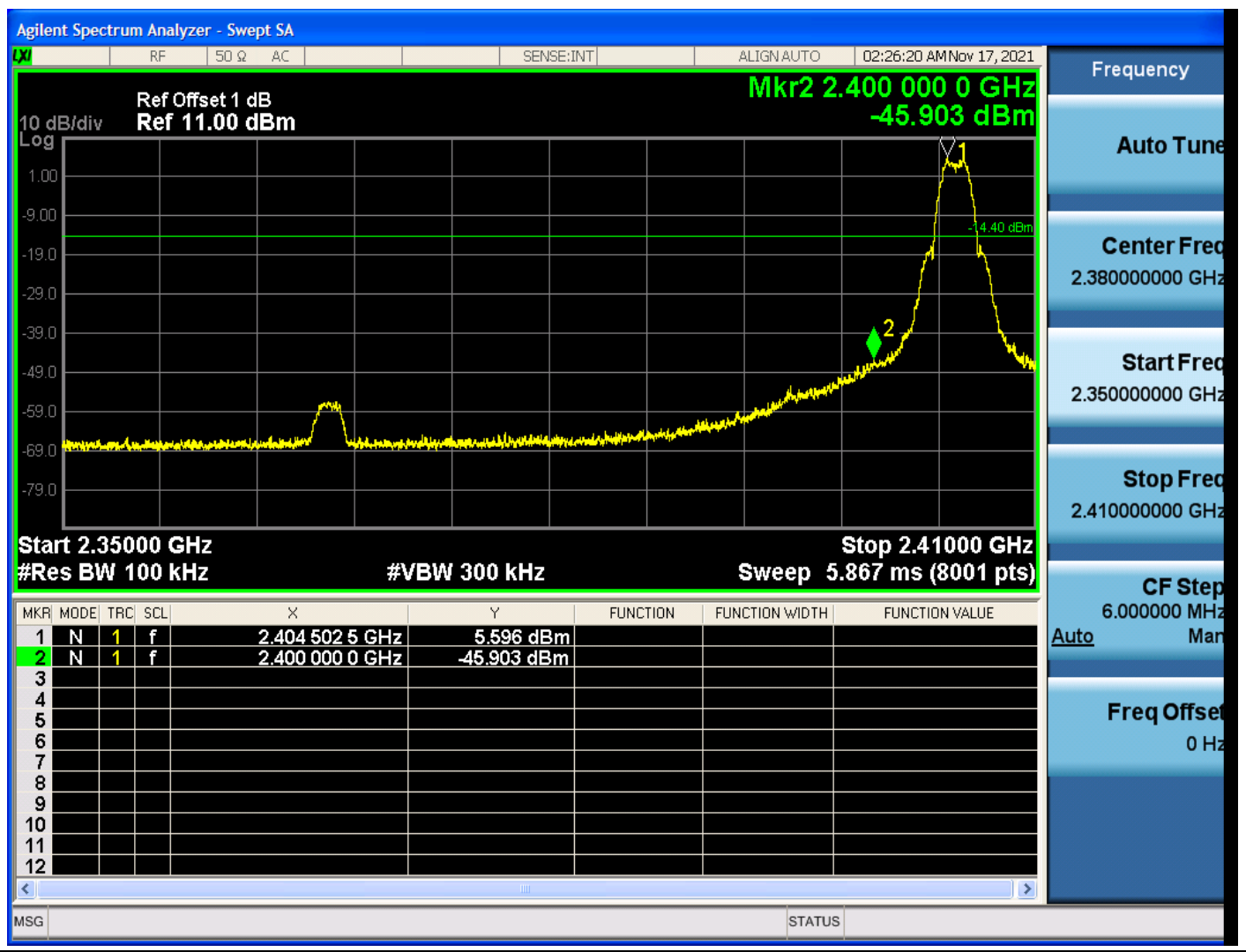

The data of entire corresponding spectrum:

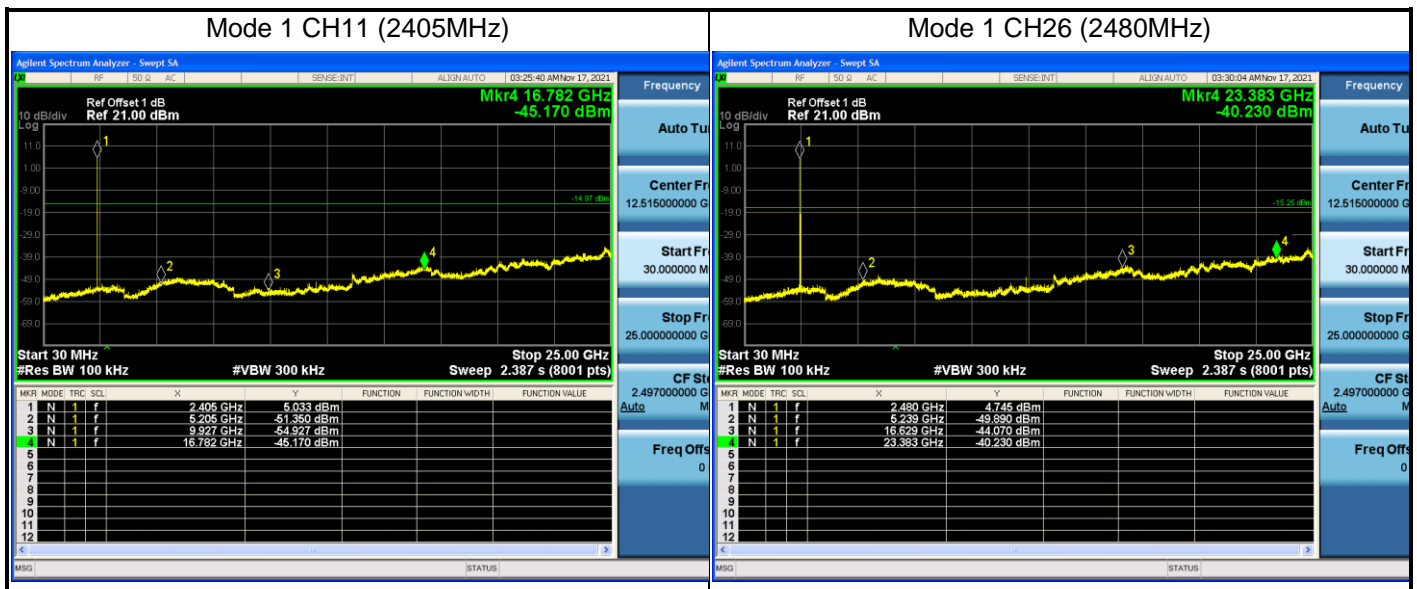

4.4 Duty cycle

VERDICT: PASS

4.4.1 Limit

N/A

4.4.2 Test Setup

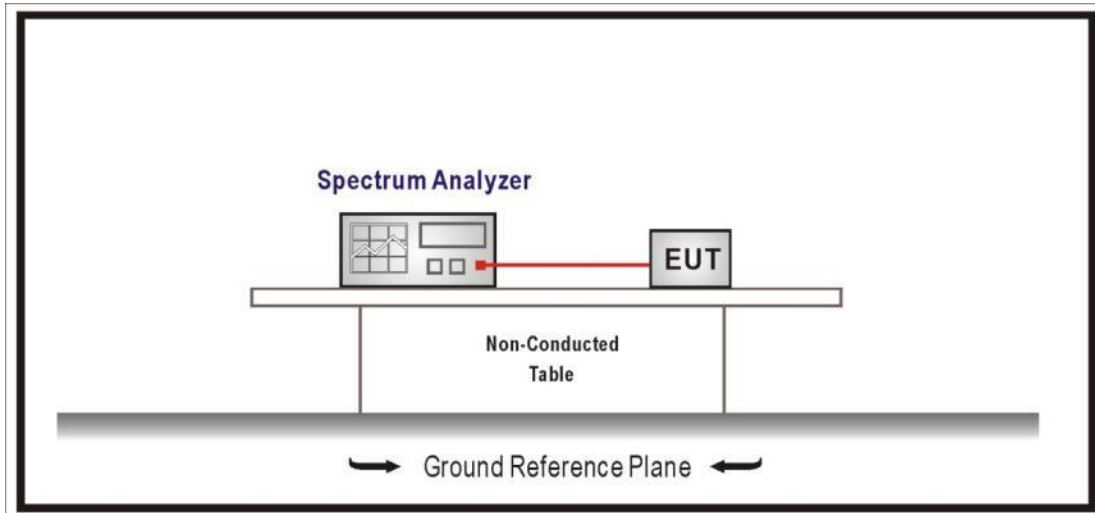

4.4.3 Test Procedure

References Rule	Chapter	Description
<input checked="" type="checkbox"/> ANSI C63.10	11.6	Duty cycle (D), transmission duration (T), and maximum power control level

4.4.4 Test Data

Test Mode	Tx On (us)	Tx Off (us)	VBW (kHz)	Tx On + Tx Off (us)	Duty Cycle (%)
Mode 1	--	--	--	--	100

Note 1: T means the minimum transmission duration over which the transmitter is on and is transmitting at its maximum power control level for the tested mode of operation.

Note 2: According to KDB 558074, when test for Radiated Emission Band Edge and Radiated Emission, for average detector set: $VBW \geq 1/T$ will be used.

Mode 1 CH18 2440MHz

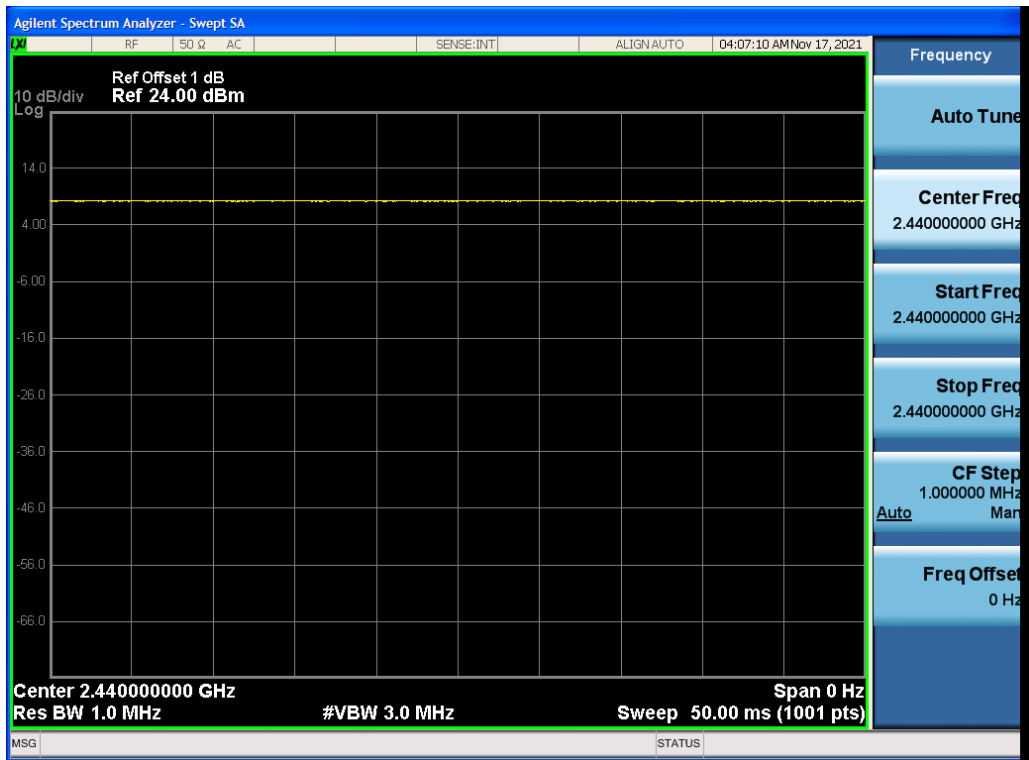

4.5 Radiated Emission Band Edge	VERDICT: PASS
--	----------------------

4.5.1 Limit

Standard		FCC Part 15 Subpart C Paragraph 15.247(d) , 15.209		
Frequency bands (MHz)	Detector	Limit (dBµV/m)	RBW (MHz)	Distance (m)
2310-2390	PK	74	1	3
2483.5-2500	AV	54	1	3

Note: The field strength of emissions appearing within these frequency bands shall not exceed the limits.

4.5.2 Test Setup

Above 1GHz Test Setup:

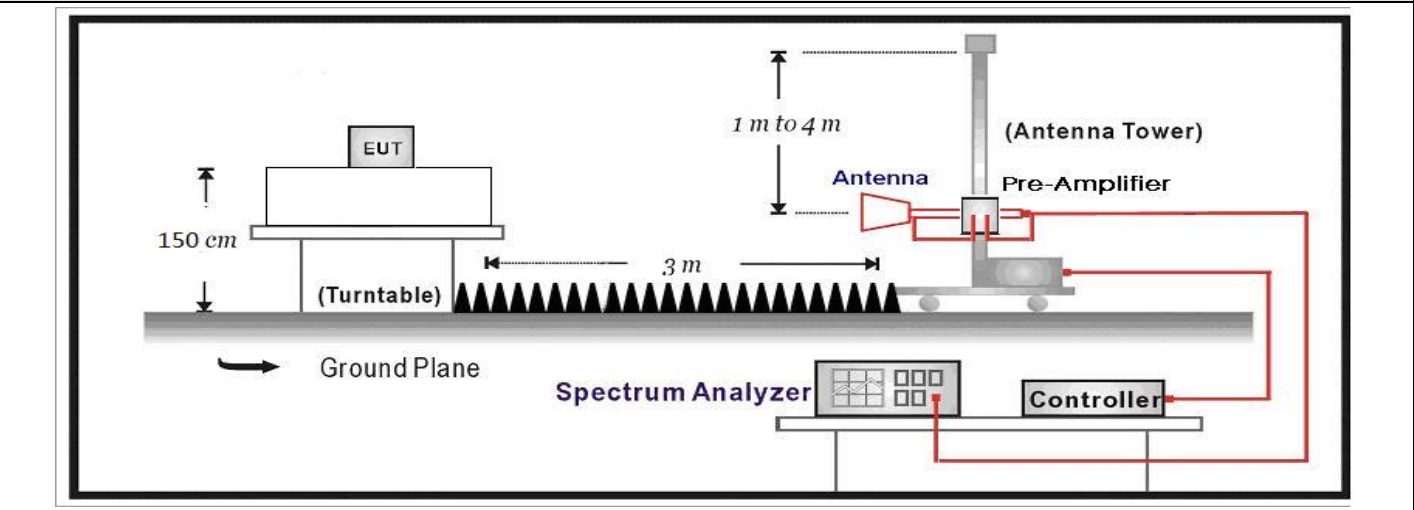

4.5.3 Test Procedure

	References Rule	Chapter	Description
<input checked="" type="checkbox"/>	ANSI C63.10	6.10	Band-edge testing
<input checked="" type="checkbox"/>	ANSI C63.10	6.10.5	Restricted-band band-edge measurements
<input type="checkbox"/>	ANSI C63.10	6.10.6	Marker-delta method
<input checked="" type="checkbox"/>	ANSI C63.10	11.12	Emissions in restricted frequency bands
<input checked="" type="checkbox"/>	ANSI C63.10	11.12.1	Radiated emission measurements
<input checked="" type="checkbox"/>	ANSI C63.10	11.12.2.7	Radiated spurious emission test
<input type="checkbox"/>	ANSI C63.10	6.4	Radiated emissions from unlicensed wireless devices below 30 MHz
<input type="checkbox"/>	ANSI C63.10	6.5	Radiated emissions from unlicensed wireless devices in the frequency range of 30 MHz to 1000 MHz
<input checked="" type="checkbox"/>	ANSI C63.10	6.6	Radiated emissions from unlicensed wireless devices above 1 GHz

4.5.4 Test Data

Profile: 21B0246R	Page No.: 33
Engineer: Juliuszhou	
Site: AC5	Time: 2021/05/25 - 20:57
Limit: FCC_Part15.209_RE(3m)	Margin: 0
Probe: Horn_3117_00123988_(1-18GHz)	Polarity: Vertical
EUT: LED Device	Power: AC 120V/60Hz
Note: Mode 1: Transmit at 2405MHz by Zigbee	

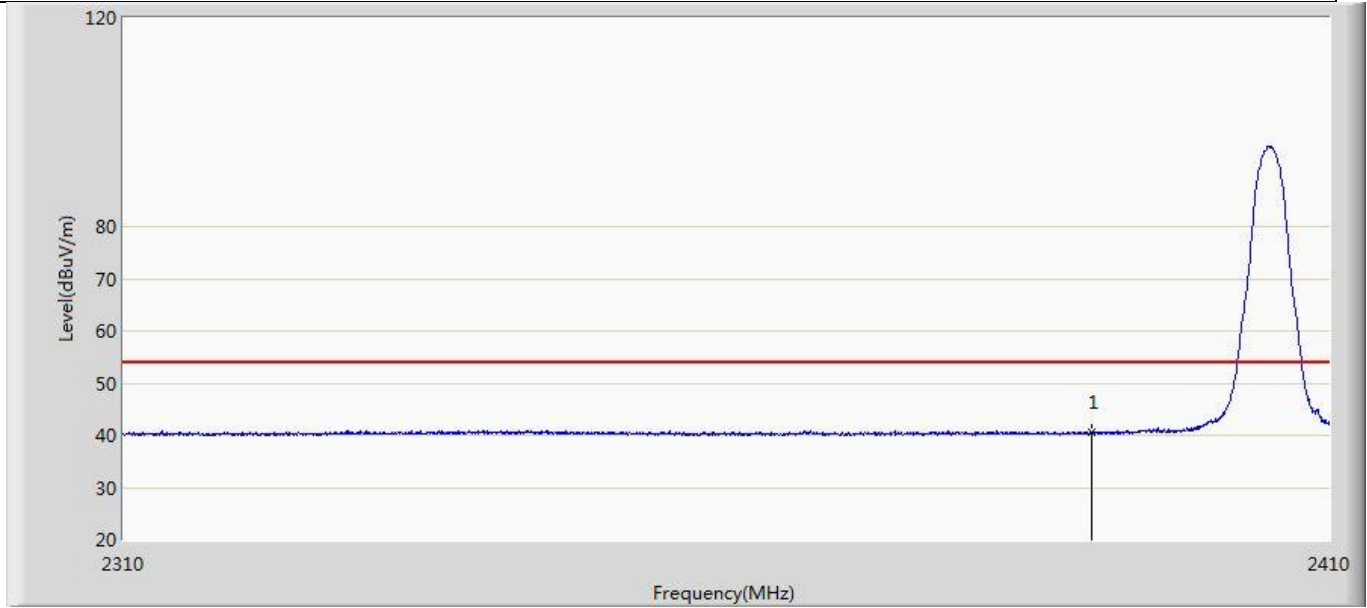

No	Mark	Frequency (MHz)	Measure Level (dBuV/m)	Reading Level (dBuV)	Over Limit (dB)	Limit (dBuV/m)	Factor (dB)	Type
1	*	2390.000	40.465	5.006	-13.535	54.000	35.459	AV

Profile: 21B0246R	Page No.: 34
Engineer: Juliuszhou	
Site: AC5	Time: 2021/05/25 - 21:13
Limit: FCC_Part15.209_RE(3m)	Margin: 0
Probe: Horn_3117_00123988_(1-18GHz)	Polarity: Vertical
EUT: LED Device	Power: AC 120V/60Hz
Note: Mode 1:Transmit at 2405MHz by Zigbee	

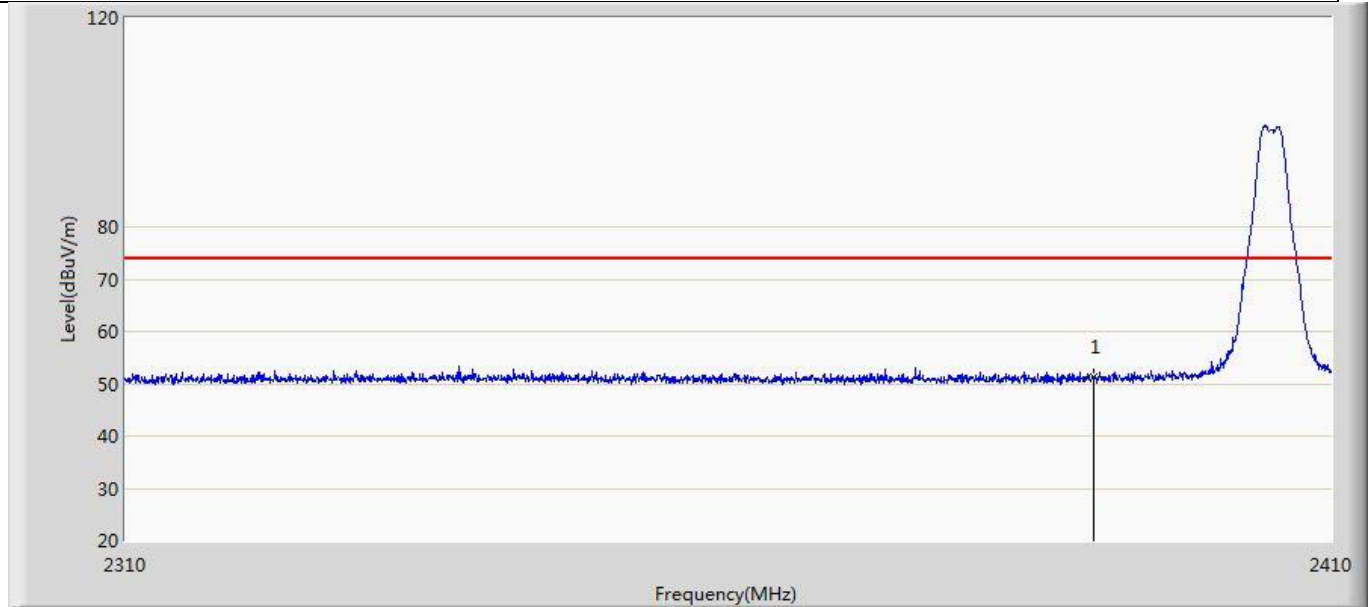

No	Mark	Frequency (MHz)	Measure Level (dBuV/m)	Reading Level (dBuV)	Over Limit (dB)	Limit (dBuV/m)	Factor (dB)	Type
1	*	2390.000	51.167	15.708	-22.833	74.000	35.459	PK

Profile: 21B0246R	Page No.: 35
Engineer: Juliuszhou	
Site: AC5	Time: 2021/05/25 - 21:16
Limit: FCC_Part15.209_RE(3m)	Margin: 0
Probe: Horn_3117_00123988_(1-18GHz)	Polarity: Horizontal
EUT: LED Device	Power: AC 120V/60Hz
Note: Mode 1:Transmit at 2405MHz by Zigbee	

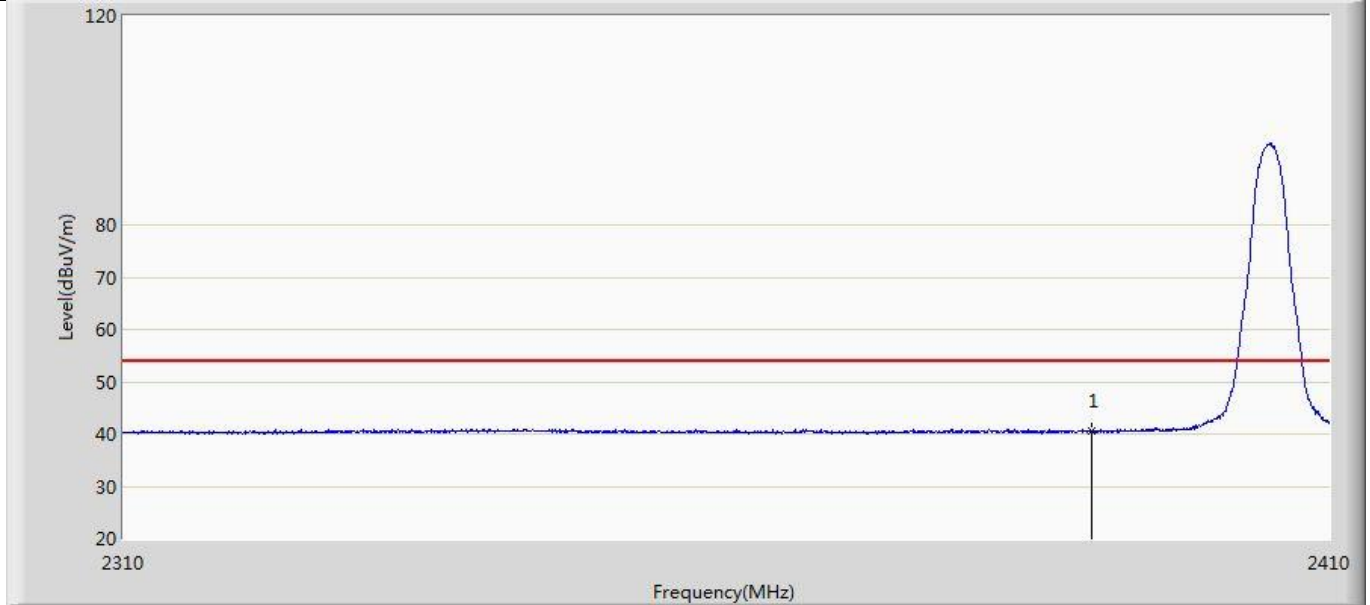

No	Mark	Frequency (MHz)	Measure Level (dBuV/m)	Reading Level (dBuV)	Over Limit (dB)	Limit (dBuV/m)	Factor (dB)	Type
1	*	2390.000	40.634	5.175	-13.366	54.000	35.459	AV

Profile: 21B0246R	Page No.: 36
Engineer: Juliuszhou	
Site: AC5	Time: 2021/05/25 - 21:16
Limit: FCC_Part15.209_RE(3m)	Margin: 0
Probe: Horn_3117_00123988_(1-18GHz)	Polarity: Horizontal
EUT: LED Device	Power: AC 120V/60Hz
Note: Mode 1:Transmit at 2405MHz by Zigbee	

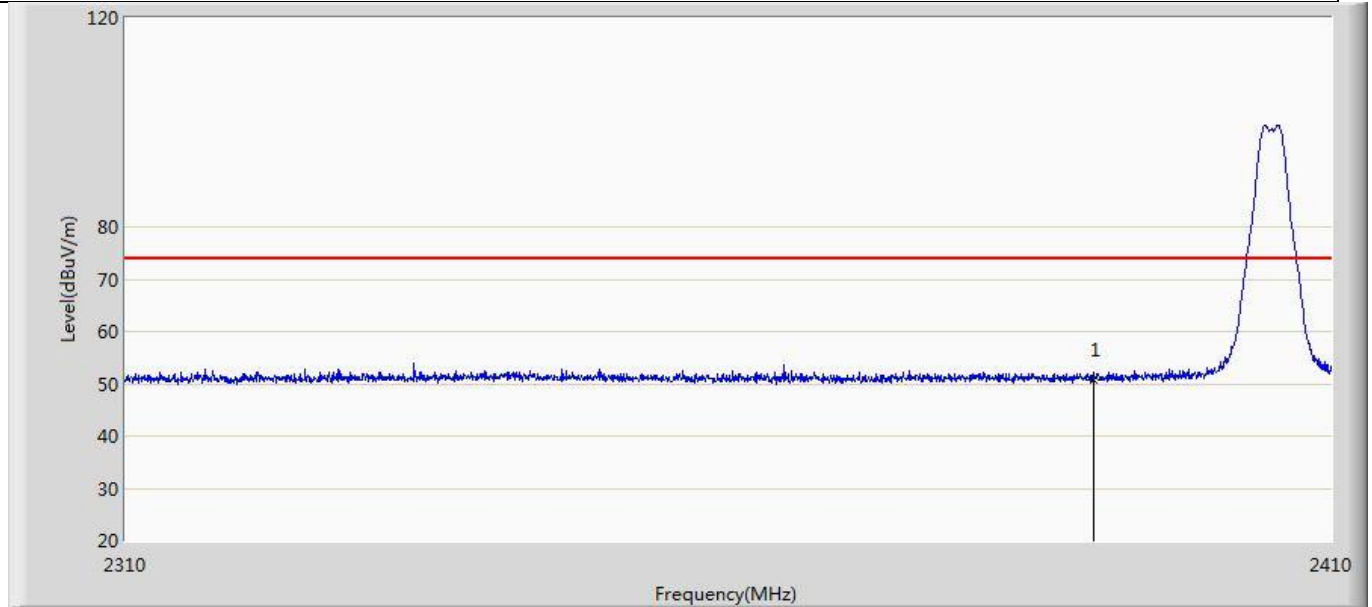

No	Mark	Frequency (MHz)	Measure Level (dBuV/m)	Reading Level (dBuV)	Over Limit (dB)	Limit (dBuV/m)	Factor (dB)	Type
1	*	2390.000	50.779	15.320	-23.221	74.000	35.459	PK

Profile: 21B0246R	Page No.: 37
Engineer: Juliuszhou	
Site: AC5	Time: 2021/05/25 - 21:18
Limit: FCC_Part15.209_RE(3m)	Margin: 0
Probe: Horn_3117_00123988_(1-18GHz)	Polarity: Vertical
EUT: LED Device	Power: AC 120V/60Hz
Note: Mode 1:Transmit at 2480MHz by Zigbee	

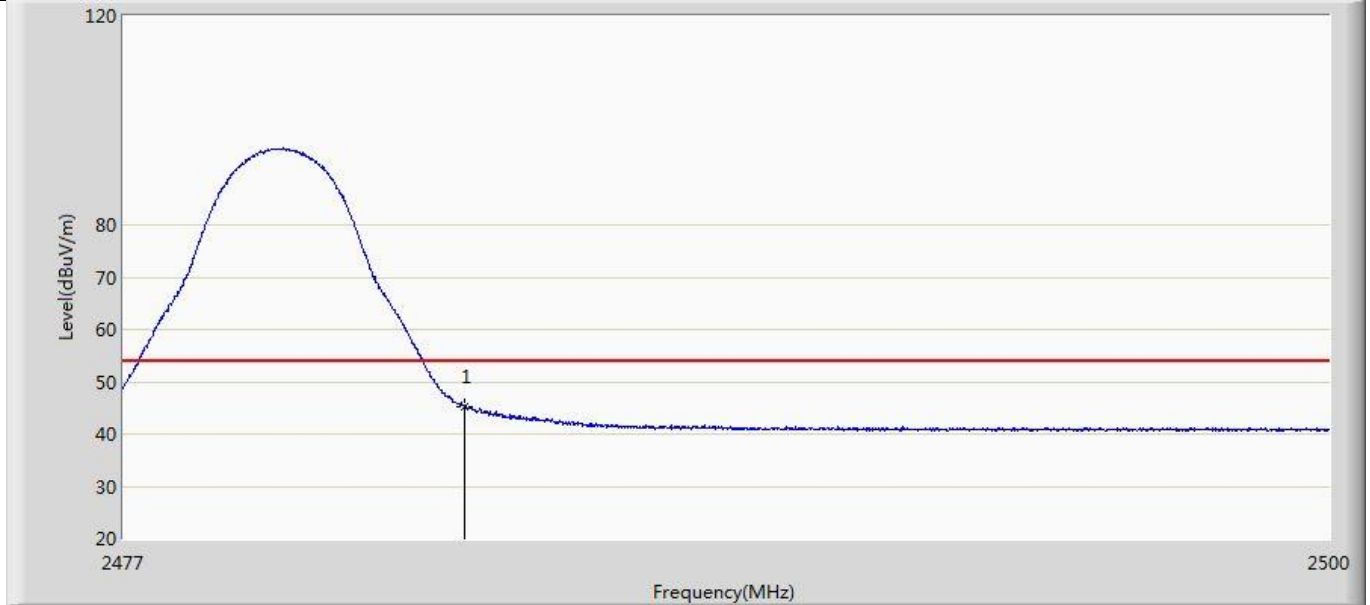

No	Mark	Frequency (MHz)	Measure Level (dBuV/m)	Reading Level (dBuV)	Over Limit (dB)	Limit (dBuV/m)	Factor (dB)	Type
1	*	2483.500	45.218	9.543	-8.782	54.000	35.675	AV

Profile: 21B0246R	Page No.: 38
Engineer: Juliuszhou	
Site: AC5	Time: 2021/05/25 - 21:20
Limit: FCC_Part15.209_RE(3m)	Margin: 0
Probe: Horn_3117_00123988_(1-18GHz)	Polarity: Vertical
EUT: LED Device	Power: AC 120V/60Hz
Note: Mode 1:Transmit at 2480MHz by Zigbee	

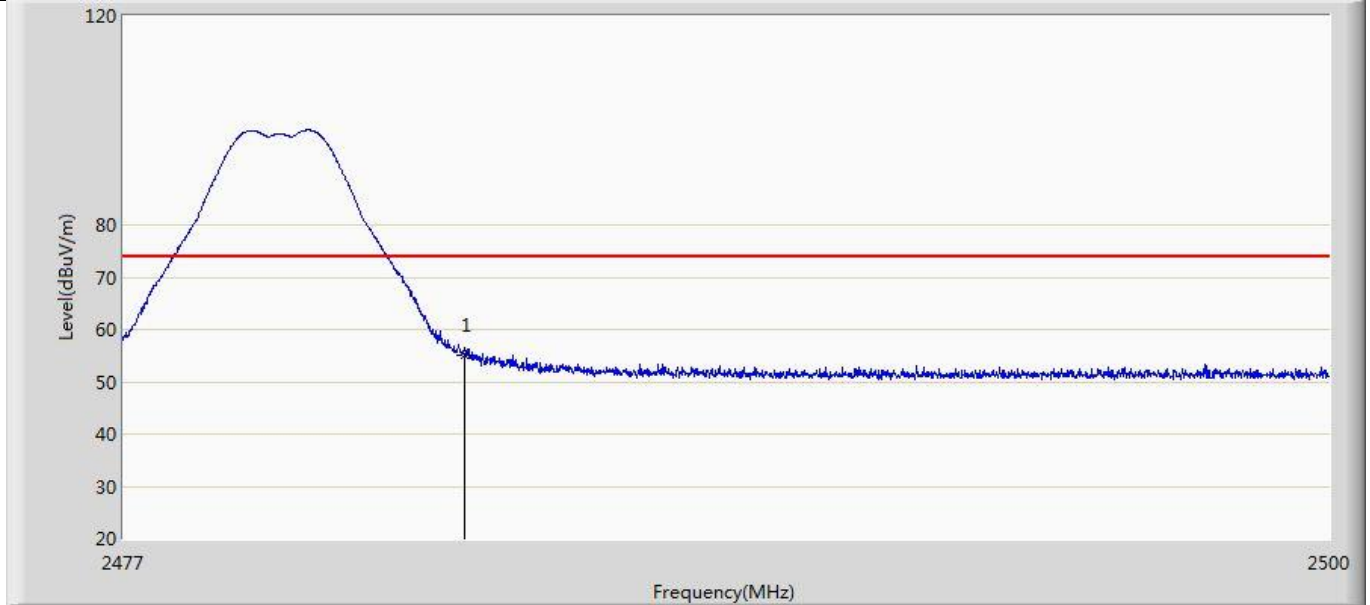

No	Mark	Frequency (MHz)	Measure Level (dBuV/m)	Reading Level (dBuV)	Over Limit (dB)	Limit (dBuV/m)	Factor (dB)	Type
1	*	2483.500	55.019	19.344	-18.981	74.000	35.675	PK

Profile: 21B0246R	Page No.: 39
Engineer: Juliuszhou	
Site: AC5	Time: 2021/05/25 - 21:20
Limit: FCC_Part15.209_RE(3m)	Margin: 0
Probe: Horn_3117_00123988_(1-18GHz)	Polarity: Horizontal
EUT: LED Device	Power: AC 120V/60Hz
Note: Mode 1:Transmit at 2480MHz by Zigbee	

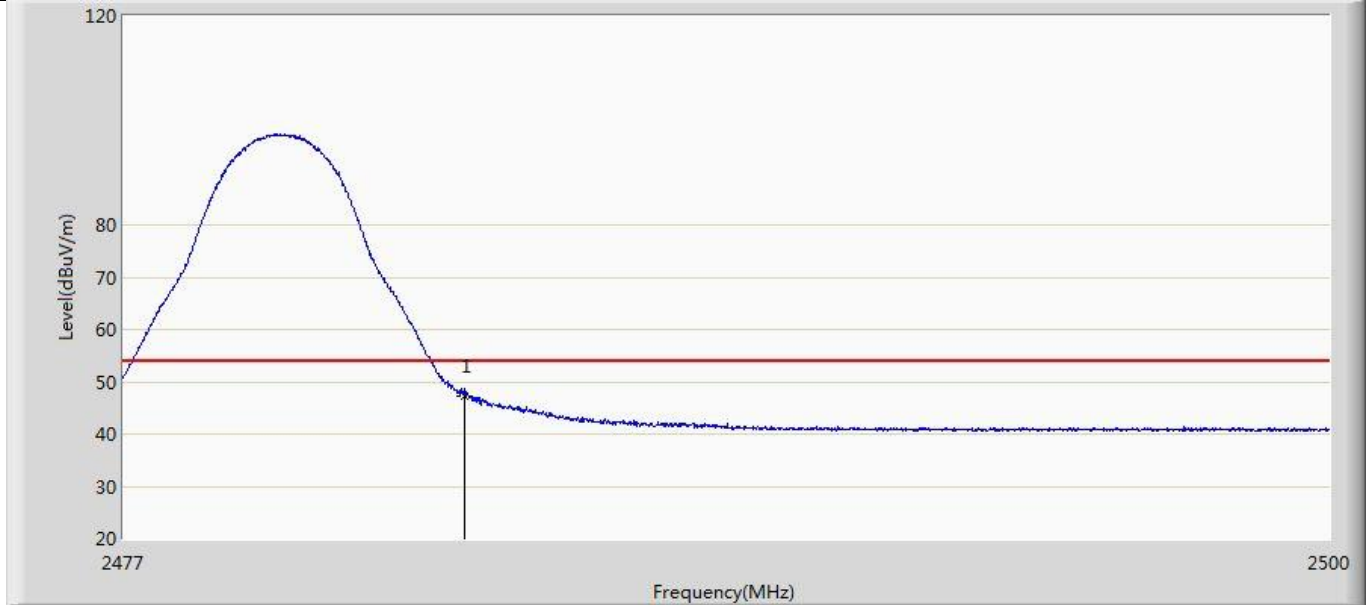

No	Mark	Frequency (MHz)	Measure Level (dBuV/m)	Reading Level (dBuV)	Over Limit (dB)	Limit (dBuV/m)	Factor (dB)	Type
1	*	2483.500	47.299	11.624	-6.701	54.000	35.675	AV

Profile: 21B0246R	Page No.: 40
Engineer: Juliuszhou	
Site: AC5	Time: 2021/05/25 - 21:20
Limit: FCC_Part15.209_RE(3m)	Margin: 0
Probe: Horn_3117_00123988_(1-18GHz)	Polarity: Horizontal
EUT: LED Device	Power: AC 120V/60Hz
Note: Mode 1:Transmit at 2480MHz by Zigbee	

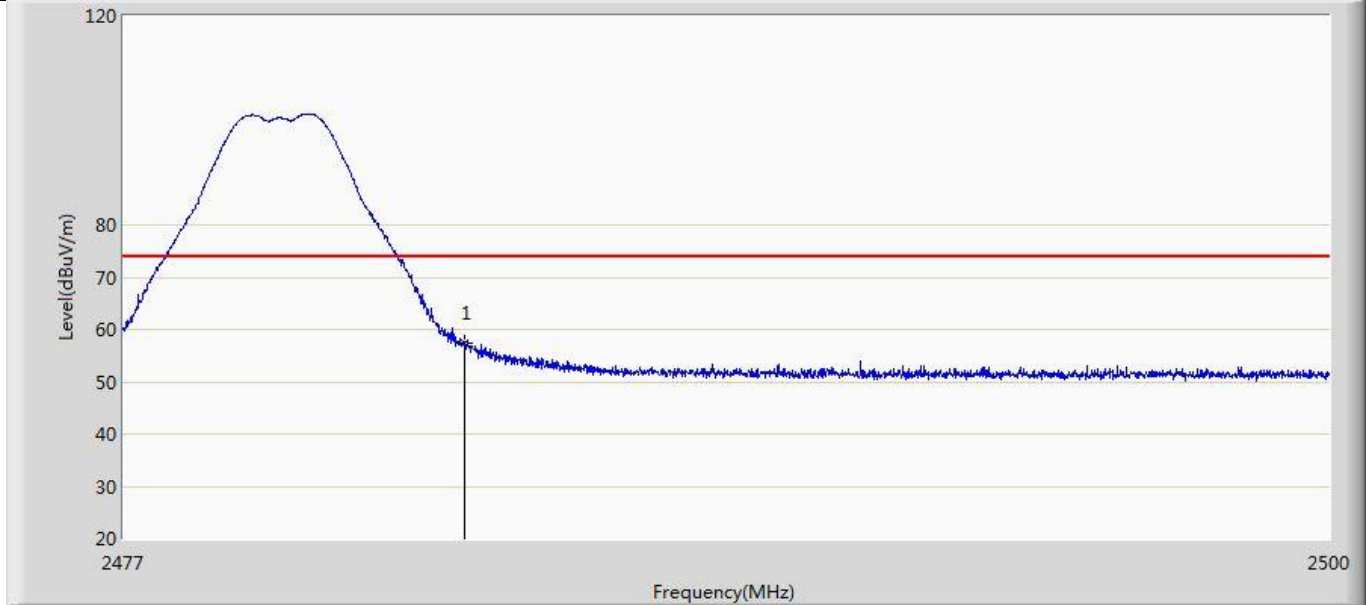

No	Mark	Frequency (MHz)	Measure Level (dBuV/m)	Reading Level (dBuV)	Over Limit (dB)	Limit (dBuV/m)	Factor (dB)	Type
1	*	2483.500	57.263	21.588	-16.737	74.000	35.675	PK

4.6 DTS Bandwidth	VERDICT: PASS
--------------------------	----------------------

4.6.1 Limit

Standard	FCC Part 15 Subpart C Paragraph 15.247 (a)(2)
Systems using digital modulation techniques operate in the 2400-2483.5 MHz. The minimum 6 dB bandwidth shall be at least 500 kHz	

4.6.2 Test Setup

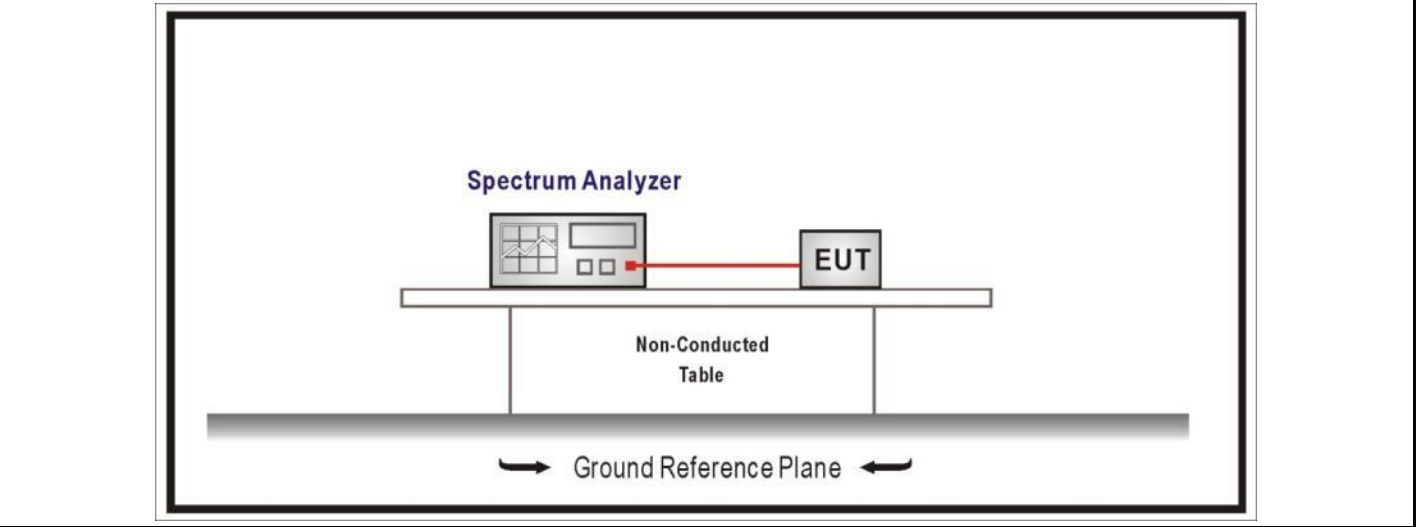

4.6.3 Test Procedure

	Reference Rule	Chapter	Description
<input checked="" type="checkbox"/>	ANSI C63.10	11.8	DTS bandwidth
<input type="checkbox"/>	ANSI C63.10	11.8.1	Option 1
<input checked="" type="checkbox"/>	ANSI C63.10	11.8.2	Option 2

4.6.4 Test Data

Mode	CH.	Test Freq. (MHz)	99% Occupied Bandwidth (kHz)	6dB Occupied Bandwidth (kHz)	Limit (kHz)	Result
1	11	2405	2326.2	1663	>500	Pass
	18	2440	2325.7	1674	>500	Pass
	26	2480	2323.1	1743	>500	Pass

Note : The worst case of Occupied Bandwidth as below:

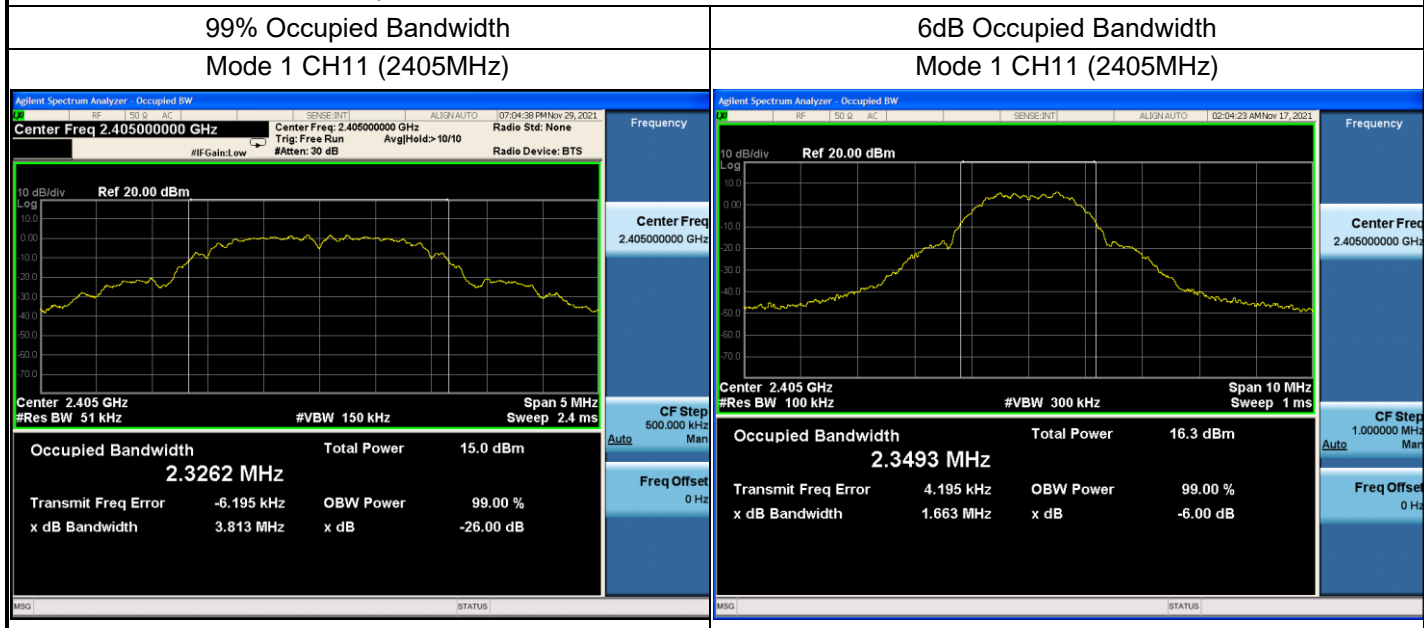

4.7 Fundamental emission output power	VERDICT: PASS
--	----------------------

4.7.1 Limit		
Standard	FCC Part 15 Subpart C Paragraph 15.247 (b)(3)	
<input checked="" type="checkbox"/>	GTX < 6dBi	Pout ≤ 30dBm
<input type="checkbox"/>	GTX > 6dBi	
<input type="checkbox"/>	Non-Fix point-point	Pout ≤ 30 - (GTX - 6)
<input type="checkbox"/>	Fix point-point	Pout ≤ 30 - [(GTX - 6)]/3
<input type="checkbox"/>	Point-to-multipoint	Pout ≤ 30 - (GTX - 6)
<input type="checkbox"/>	Overlap Beams	Pout ≤ 30 - [(GTX - 6)]/3
<input type="checkbox"/>	Aggregate power transmitted simultaneously on all beams	Pout ≤ 30 - [(GTX - 6)]/3
<input type="checkbox"/>	single directional beam	Pout ≤ 30 - [(GTX - 6)]/3 + 8dB
<p>Note 1 : GTX directional gain of transmitting antennas.</p> <p>Note 2 : Pout is maximum peak conducted output power .</p>		

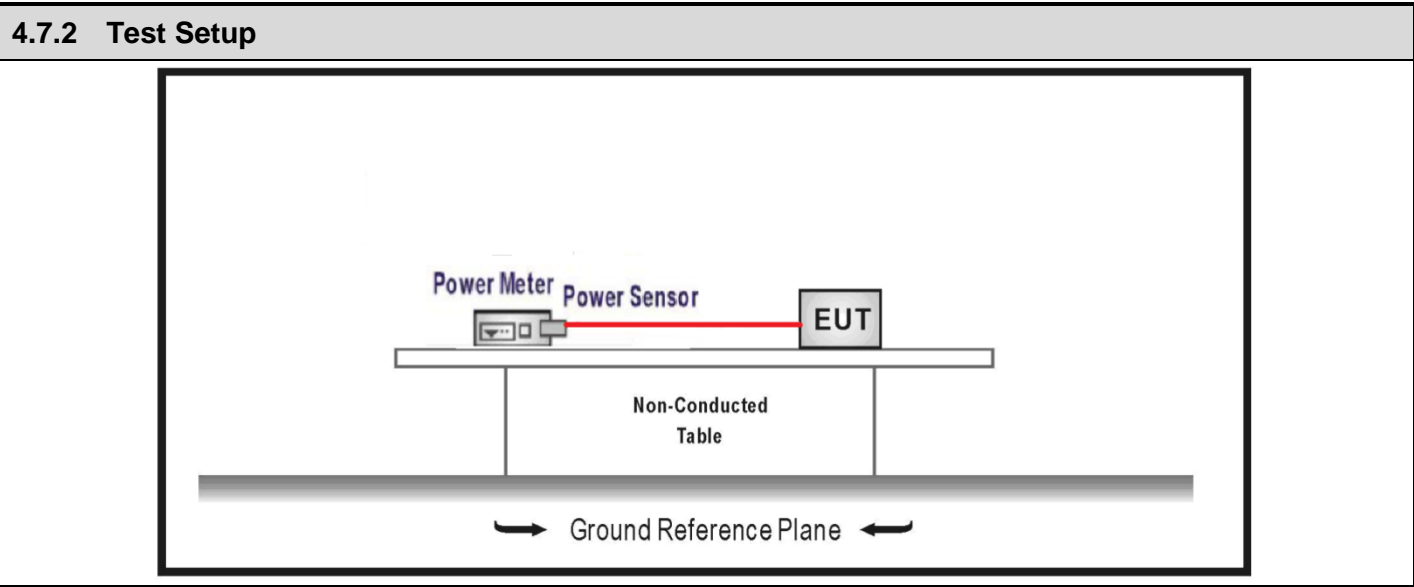

4.7.3 Test Procedure				
	References Rule		Chapter	Description
<input checked="" type="checkbox"/>	ANSI C63.10		11.9	Fundamental emission output power
	<input checked="" type="checkbox"/>	ANSI C63.10	11.9.1	Maximum peak conducted output power
	<input type="checkbox"/>	ANSI C63.10	11.9.1.1	RBW \geq DTS bandwidth
	<input type="checkbox"/>	ANSI C63.10	11.9.1.2	Integrated band power method
	<input type="checkbox"/>	ANSI C63.10	11.9.1.3	PKPM1 Peak power meter method
	<input type="checkbox"/>	ANSI C63.10	11.9.2	Maximum conducted (average) output power
	<input type="checkbox"/>	ANSI C63.10	11.9.2.2	Measurement using a spectrum analyzer (SA)
		<input type="checkbox"/>	ANSI C63.10	11.9.2.2.2 Method AVGSA-1(Duty cycle \geq 98%)
		<input type="checkbox"/>	ANSI C63.10	11.9.2.2.3 Method AVGSA-1A(Duty cycle \geq 98%)
		<input type="checkbox"/>	ANSI C63.10	11.9.2.2.4 Method AVGSA-2(Duty cycle \leq 98%)
		<input type="checkbox"/>	ANSI C63.10	11.9.2.2.5 Method AVGSA-2A(Duty cycle \leq 98%)
		<input type="checkbox"/>	ANSI C63.10	11.9.2.2.4 Method AVGSA-3
		<input type="checkbox"/>	ANSI C63.10	11.9.2.2.5 Method AVGSA-3A
	<input checked="" type="checkbox"/>	ANSI C63.10	11.9.2.3	Measurement using a power meter (PM)
		<input checked="" type="checkbox"/>	ANSI C63.10	11.9.2.3.1 Method AVGPM
		<input type="checkbox"/>	ANSI C63.10	11.9.2.3.2 Method AVGPM-G

4.7.4	Test Data						
Mode	Channel	Test Frequency (MHz)	Power Output (dBm)	EIRP Power Output (dBm)	Limit (dBm)	EIRP Limit (dBm)	Result
Mode 1	11	2405	9.63	11.71	≤30	≤36	Pass
	18	2440	9.37	11.45	≤30	≤36	Pass
	26	2480	9.44	11.52	≤30	≤36	Pass

4.8 Power Density

VERDICT: PASS

4.8.1 Limit:

Standard FCC Part 15 Subpart C Paragraph 15.247 (b)(3)

Power Spectral Density $\leq 8\text{dBm}/3\text{kHz}$

4.8.2 Test Setup

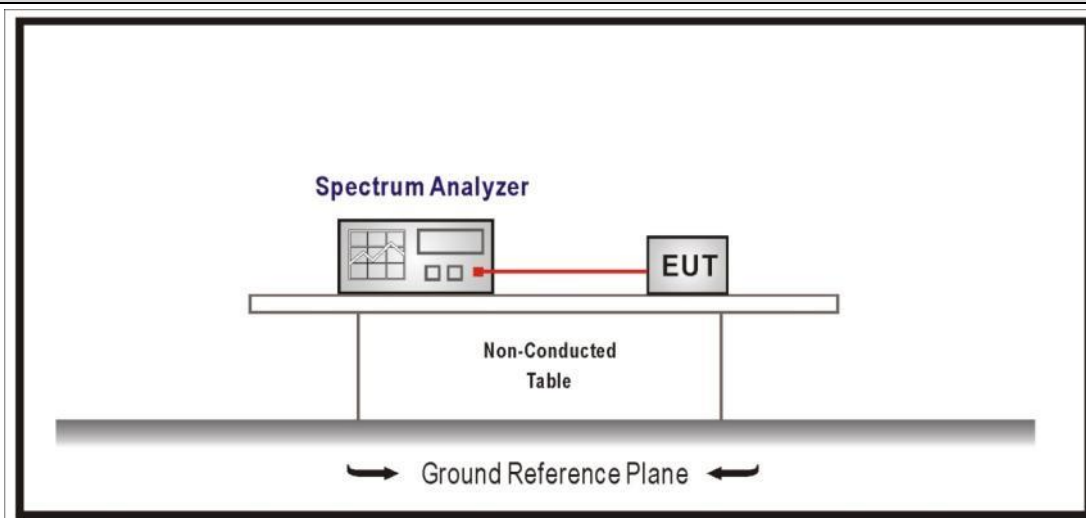

4.8.3 Test Procedure

	References Rule	Chapter	Description
<input checked="" type="checkbox"/>	ANSI C63.10	11.10	Maximum power spectral density level in the fundamental emission
<input checked="" type="checkbox"/>	ANSI C63.10	11.10.2	Method PKPSD (peak PSD)
<input type="checkbox"/>	ANSI C63.10	11.10.3	Method AVGPSD-1(Duty cycle $\geq 98\%$)
<input type="checkbox"/>	ANSI C63.10	11.10.4	Method AVGPSD-1A(Duty cycle $\geq 98\%$)
<input type="checkbox"/>	ANSI C63.10	11.10.5	Method AVGPSD-2(Duty cycle $< 98\%$)
<input type="checkbox"/>	ANSI C63.10	11.10.6	Method AVGPSD-2A(Duty cycle $< 98\%$)
<input type="checkbox"/>	ANSI C63.10	11.10.7	Method AVGPSD-3
<input type="checkbox"/>	ANSI C63.10	11.10.8	Method AVGPSD-3A

4.8.4 Test Data

Mode	Channel	Test Frequency (MHz)	Measurement PSD (dBm/3kHz)	Limit (dBm/3kHz)	Result
Mode 1	11	2405	-6.576	≤8	Pass
	18	2440	-7.006	≤8	Pass
	26	2480	-6.182	≤8	Pass

Note : The worst case of PSD as below:

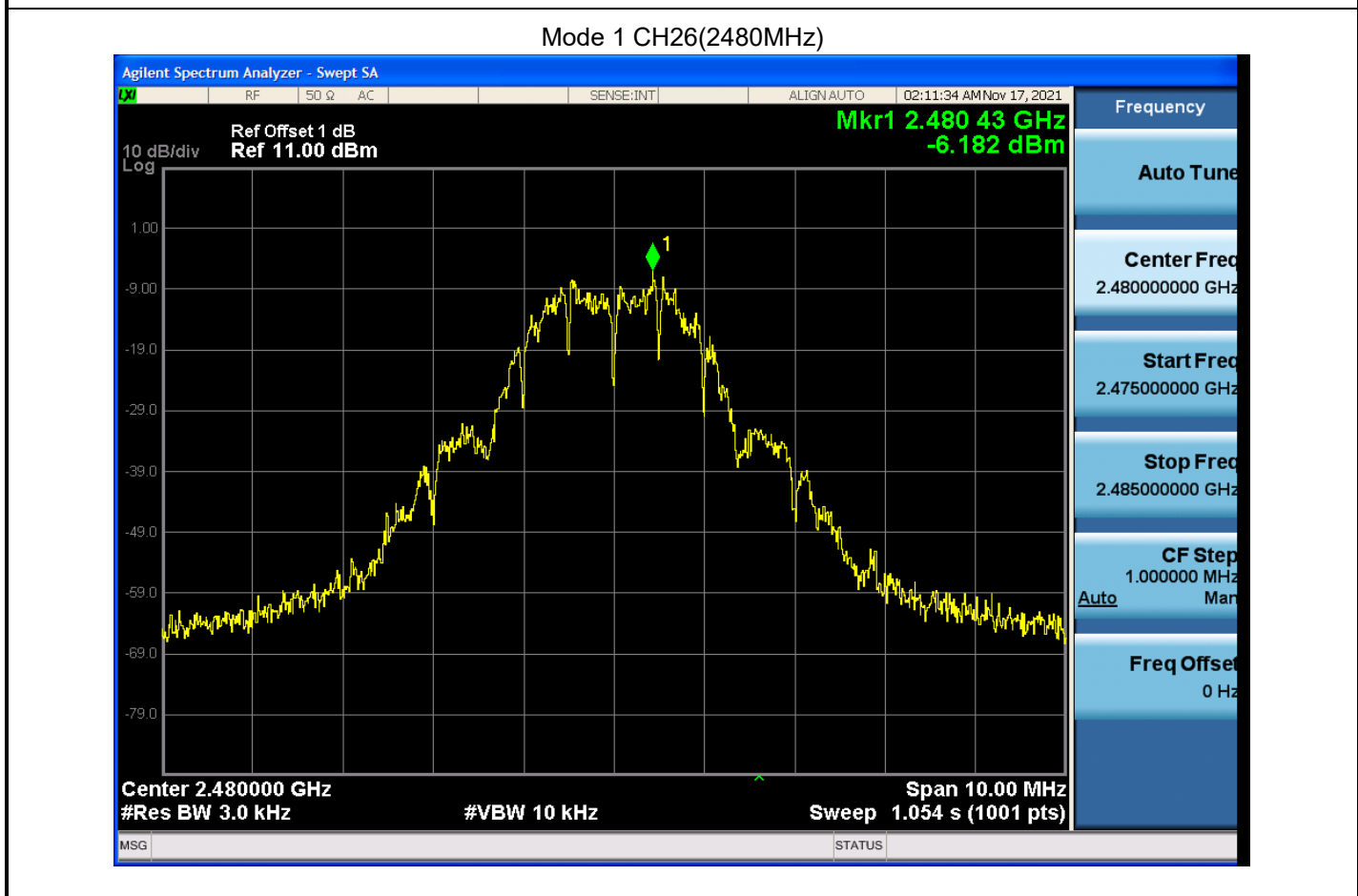

4.9 Antenna Requirement	VERDICT: PASS
--------------------------------	----------------------

4.9.1 Limit:	
Standard	FCC Part 15 Subpart C Paragraph 15.203
<p>An intentional radiator shall be designed to ensure that no antenna other than that furnished by the responsible party shall be used with the device. The use of a permanently attached antenna or of an antenna that uses a unique coupling to the intentional radiator shall be considered sufficient to comply with the provisions of this section. The manufacturer may design the unit so that a broken antenna can be replaced by the user, but the use of a standard antenna jack or electrical connector is prohibited. This requirement does not apply to carrier current devices or to devices operated under the provisions of §15.211, §15.213, §15.217, §15.219, or §15.221. Further, this requirement does not apply to intentional radiators that must be professionally installed, such as perimeter protection systems and some field disturbance sensors, or to other intentional radiators which, in accordance with §15.31(d), must be measured at the installation site. However, the installer shall be responsible for ensuring that the proper antenna is employed so that the limits in this part are not exceeded.</p>	

4.9.2 Antenna Connector Construction:	
<input checked="" type="checkbox"/>	The use of a permanently attached antenna
<input type="checkbox"/>	The antenna use of a unique coupling to the intentional radiator
<input type="checkbox"/>	The use of a nonstandard antenna jack or electrical connector
Please refer to the attached document "Internal Photograph" to show the antenna connector.	

5 TEST SETUP PHOTO AND EUT PHOTO

Remark: The test setup photo and EUT Photo please see appendix.

_____ The End _____



Test report No:
21B0246R-RF-US-P06V02

FCC & ISED TEST REPORT

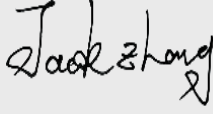
Product Name	LED Device
Trademark	PHILIPS
Model and /or type reference	9290024227; 9290024228; 9290024229
FCC ID	2AGBW9290024227X(9290024227) 2AGBW9290024228X(9290024228) 2AGBW9290024229X(9290024229)
IC	20812-4227X(9290024227) 20812-4228X(9290024228) 20812-4229X(9290024229)
Applicant's name / address	Signify (China) Investment Co., Ltd. Building no.9, Lane 888, Tianlin Road, Minhang District, Shanghai 200233, China
Test method requested, standard	FCC CFR Title 47 Part 15 Subpart C Section 15.247 ANSI C63.10: 2013 KD558074 D01 15.247 Meas Guidance v05r02 RSS-Gen Issue 5 RSS-247 Issue 2
Verdict Summary	IN COMPLIANCE
Documented by (name / position & signature)	Adma Lu/Project Engineer 
Approved by (name / position & signature)	Jack Zhang/ Supervisor 
Date of issue	2021-12-23
Report template No	Template_FCC 15.247-RF-V1.0

INDEX

	page
General conditions	4
Environmental conditions	4
Possible test case verdicts	5
Abbreviations.....	5
Document History.....	6
Remarks and Comments	6
Used Equipment.....	7
Uncertainty	9
1 General Information	10
1.1 General Description of the Item(s).....	10
1.2 Antenna Information	11
1.3 Channel List.....	12
2 Description of Test Setup.....	13
2.1 Operating mode(s) used for tests	13
2.2 Test Configuration / Block diagram used for tests.....	14
2.3 Testing process	15
3 Verdict summary section.....	16
3.1 Standards	16
3.2 Deviation(s) from the Standard(s) / Test Specification(s).....	16
3.3 Overview of results	17
3.4 Test Facility.....	18
4 Test Results	19
4.1 AC Power Line Conducted Emission.....	19
4.1.1 Limit	19
4.1.2 Test Setup	19
4.1.3 Test Procedure	19
4.1.4 Test Data	20
4.2 Emissions in restricted frequency bands	22
4.2.1 Limit	22
4.2.2 Test Setup	24
4.2.3 Test Procedure	24
4.2.4 Test Data	25
4.3 Emissions in non-restricted frequency band	51
4.3.1 Limit	51

4.3.2	Test Setup	51
4.3.3	Test Procedure	51
4.3.4	Test Data	52
4.4	Duty cycle	55
4.4.1	Limit	55
4.4.2	Test Setup	55
4.4.3	Test Procedure	55
4.4.4	Test Data	56
4.5	Radiated Emission Band Edge	57
4.5.1	Limit	57
4.5.2	Test Setup	57
4.5.3	Test Procedure	57
4.5.4	Test Data	58
4.6	DTS Bandwidth	90
4.6.1	Limit	90
4.6.2	Test Setup	90
4.6.3	Test Procedure	90
4.6.4	Test Data	91
4.7	Fundamental emission output power	92
4.7.1	Limit	92
4.7.2	Test Setup	92
4.7.3	Test Procedure	93
4.7.4	Test Data	94
4.8	Power Density	95
4.8.1	Limit:	95
4.8.2	Test Setup	95
4.8.3	Test Procedure	95
4.8.4	Test Data	96
4.9	Antenna Requirement	97
4.9.1	Limit:	97
4.9.2	Antenna Connector Construction:	97
5	Test setup photo and EUT Photo	98

COMPETENCES AND GUARANTEES

DEKRA is a testing laboratory competent to carry out the tests described in this report.

In order to assure the traceability to other national and international laboratories, DEKRA has a calibration and maintenance program for its measurement equipment.

DEKRA guarantees the reliability of the data presented in this report, which is the result of the measurements and the tests performed to the item under test on the date and under the conditions stated in the report and it is based on the knowledge and technical facilities available at DEKRA at the time of performance of the test.

DEKRA is liable to the client for the maintenance of the confidentiality of all information related to the item under test and the results of the test.

The results presented in this Test Report apply only to the particular item under test established in this document.

IMPORTANT: No parts of this report may be reproduced or quoted out of context, in any form or by any means, except in full, without the previous written permission of DEKRA.

GENERAL CONDITIONS

Test Location	No. 99, Hongye Road, Suzhou Industrial Park Suzhou, 215006, P.R. China
Date(receive sample)	Nov. 08, 2021
Date (start test)	Nov. 09, 2021
Date (finish test)	Nov. 25, 2021

1. This report is only referred to the item that has undergone the test.
2. This report does not constitute or imply on its own an approval of the product by the Certification Bodies or Competent Authorities.
3. This document is only valid if complete; no partial reproduction can be made without previous written permission of DEKRA.
4. This test report cannot be used partially or in full for publicity and/or promotional purposes without previous written permission of DEKRA.

ENVIRONMENTAL CONDITIONS

The climatic conditions during the tests are within the limits specified by the manufacturer for the operation of the EUT and the test equipment. The climatic conditions during the tests were within the following limits:

Ambient temperature	15 °C – 35 °C
Relative Humidity air	30% - 60%

If explicitly required in the basic standard or applied product / product family standard the climatic values are recorded and documented separately in this test report.

POSSIBLE TEST CASE VERDICTS

Test case does not apply to test object	N/A
Test object does meet requirement	P (Pass) / PASS
Test object does not meet requirement	F (Fail) / FAIL
Not measured	N/M

ABBREVIATIONS

For the purposes of the present document, the following abbreviations apply:

EUT	: Equipment Under Test
QP	: Quasi-Peak
CAV	: CISPR Average
AV	: Average
CDN	: Coupling Decoupling Network
SAC	: Semi-Anechoic Chamber
OATS	: Open Area Test Site
BW	: Bandwidth
AM	: Amplitude Modulation
PM	: Pulse Modulation
HCP	: Horizontal Coupling Plane
VCP	: Vertical Coupling Plane
U_N	: Nominal voltage
T_x	: Transmitter
R_x	: Receiver
N/A	: Not Applicable
N/M	: Not Measured

DOCUMENT HISTORY

Report No.	Version	Description	Issued Date
21B0246R-RF-US-P06V02	V1.0	Initial issue of report.	2021-12-23

REMARKS AND COMMENTS

1. The equipment under test (EUT) does meet the essential requirements of the stated standard(s)/test(s).
2. These test results on a sample of the device are for the purpose of demonstrating Compliance with Part 15 Subpart C Paragraph 15.247, RSS-Gen Issue 5, RSS-247 Issue 2.
3. The measurement result is considered in conformance with the requirement if it is within the prescribed limit, It is not necessary to account the uncertainty associated with the measurement result.
4. The test results presented in this report relate only to the object tested.
5. The test report shall not be reproduced without the written approval of DEKRA Testing and Certification (Suzhou) Co., Ltd.
6. This report will not be used for social proof function in China market.
7. DEKRA declines any responsibility with the following test data provided by customer that may affect the validity of result:
 - Chapter 1.1 General Description of the Item(s);
 - Chapter 1.2 Antenna Information;
 - Chapter 1.3 Channel List.

USED EQUIPMENT

AC Power Line Conducted Emission / TR1

Instrument	Manufacturer	Model No.	Serial No.	Cal. Date	Next Cal. Date
EMI Test Receiver	R&S	ESCI	100906	2021.04.28	2022.04.29
Two-Line V-Network	R&S	ENV216	101190	2021.01.27	2022.02.26
Two-Line V-Network	R&S	ENV216	101044	2021.03.20	2022.03.19
Current Probe	R&S	EZ-17	100678	2021.01.27	2022.01.26
50ohm Termination	SHX	TF2	07081403	2021.09.04	2022.09.03
50ohm Coaxial Switch	Anritsu	MP59B	6200464462	N/A	N/A
Temperature/Humidity Meter	RTS	RTS-8S	TR1-TH	2021.07.09	2022.07.08
Coaxial Cable	Suhner	RG 223	TR1-C1	2021.07.09	2022.07.08
Dekra test software	Dekra	-	-	-	-

Emissions in non-restricted frequency bands/ Occupied Bandwidth/ Fundamental emission output power Power Spectral Density / TR8

Instrument	Manufacturer	Model No.	Serial No.	Cal. Date	Next Cal. Date
Spectrum Analyzer	Agilent	N9010A	MY48030494	2021.07.11	2022.07.10
EXA Spectrum Analyzer	Keysight	N9010A	MY55370495	2021.07.11	2022.07.10
MXA Signal Analyzer	Keysight	N9020A	MY56060147	2021.07.11	2022.07.10
Dekra test software	Dekra	-	-	-	-

Radiated Emission(30MHz-1GHz) / AC3

Instrument	Manufacturer	Model No.	Serial No.	Cal. Date	Next Cal. Date
EMI Test Receiver	R&S	ESCI	100573	2021.10.30	2022.10.29
Temperature/Humidity Meter	RTS	RTS-8S	AC2-TH	2021.10.08	2022.10.07
Coaxial Cable	Huber+Suhner	RG 214	AC2-C	2021.03.31	2022.03.30
Dekra test software	Dekra	-	-	-	-

Radiated Emission / AC5(1GHz-40GHz)

Instrument	Manufacturer	Model No.	Serial No.	Cal. Date	Next Cal. Date
Spectrum Analyzer	Agilent	E4446A	MY45300103	2021.05.06	2022.05.05
DRG Horn	ETS-Lindgren	3117	00123988	2021.10.22	2022.10.21
Temperature/Humidity Meter	Zhichen	ZC1-2	AC5-TH	2021.07.09	2022.07.08
Coaxial Cable	Huber+Suhner	SUCOFLEX 106	AC5-C2	2021.03.31	2022.03.30
Dekra test software	Dekra	-	-	-	-

UNCERTAINTY

Uncertainties have been calculated according to the DEKRA internal document. The reported expanded uncertainties are based on a standard uncertainty multiplied by a coverage factor of $k=2$, providing a level of confidence of approximately 95%. The Uncertainties is comply with standard required as below.

Test item	Uncertainty
AC Power Line Conducted Emission	9kHz~150kHz: 2.80 dB 150kHz~30MHz: 2.40 dB
Peak Power Output	± 1.27 dB
Radiated Emission(30MHz~1GHz)	Horizontal: 30MHz~200MHz: 3.50 dB 300MHz~1GHz: 3.60 dB Vertical: 30MHz~200MHz: 3.60 dB 300MHz~1GHz: 3.50 dB
Radiated Emission(1GHz~26.5GHz)	Horizontal: 1GHz~18GHz: 5.00 dB Vertical: 1GHz~18GHz: 4.80 dB
RF antenna conducted test	± 1.27 dB
Radiated Emission Band Edge	± 3.9 dB
DTS Bandwidth	± 150 Hz
Occupied Bandwidth	± 1 kHz
Power Density	± 1.27 dB

1 GENERAL INFORMATION

1.1 General Description of the Item(s)

Product Name	LED Device
Model No.	9290024227; 9290024228; 9290024229
FCC ID.....	2AGBW9290024227X(9290024227) 2AGBW9290024228X(9290024228) 2AGBW9290024229X(9290024229)
IC	20812-4227X(9290024227) 20812-4228X(9290024228) 20812-4229X(9290024229)
Manufacturer	Signify (China) Investment Co., Ltd.
Manufacturer Address	Building no.9, Lane 888, Tianlin Road, Minhang District, Shanghai 200233, China
Model difference	All models have the same rated power, LED driver, RF module except different model name.

Note: Models 9290024227, 9290024228, 9290024229 only differs on the length of the LED device, three models has been pretested and DEKRA has found that model 9290024227 is the worst case. Test results for Model 9290024227, included in this report, are valid and representative for the three models 9290024227, 9290024228, 9290024229.

Wireless specification	Bluetooth 5.0					
Operating frequency range(s)	2400~2483.5MHz					
Type of Modulation	GFSK					
PHYs	<input checked="" type="checkbox"/>	LE 1M	<input checked="" type="checkbox"/>	LE 2M	<input checked="" type="checkbox"/>	LE Coded S=2/8
Data Rate	<input checked="" type="checkbox"/>	1Mbit/s	<input checked="" type="checkbox"/>	2Mbit/s	<input checked="" type="checkbox"/>	500/125 Kbit/s
Number of channel	40					

Rated power supply..... :	Voltage and Frequency					
	<input type="checkbox"/>	AC: 220 – 240 V, 50/60 Hz				
	<input checked="" type="checkbox"/>	AC: 100-130 Vac; 50/60 Hz;				
	<input type="checkbox"/>	DC: 3.2~4.2 Vdc				
	<input type="checkbox"/>	Battery:				
Mounting position	<input type="checkbox"/>	Table top equipment				
	<input checked="" type="checkbox"/>	Wall/Ceiling mounted equipment				
	<input type="checkbox"/>	Floor standing equipment				
	<input type="checkbox"/>	Head-mounted equipment				
	<input type="checkbox"/>	Other: RF module				

1.2 Antenna Information

Antenna model / type number	N/A		
Antenna serial number	N/A		
Antenna Delivery	<input checked="" type="checkbox"/>	1TX + 1RX	
	<input type="checkbox"/>	2TX + 2RX	
Antenna technology.....	<input checked="" type="checkbox"/>	SISO	
	<input type="checkbox"/>	MIMO	<input type="checkbox"/> CDD
			<input type="checkbox"/> Beam-forming
Antenna Type	<input type="checkbox"/>	External	<input type="checkbox"/> Dipole
			<input type="checkbox"/> Sectorized
	<input checked="" type="checkbox"/>	Internal	<input checked="" type="checkbox"/> PIFA
			<input type="checkbox"/> PCB
			<input type="checkbox"/> Metal Monopole Antenna
			<input type="checkbox"/> Others.....
Antenna Gain	2.08 dBi		

1.3 Channel List

Bluetooth Working Frequency of Each Channel:							
Channel	Frequency	Channel	Frequency	Channel	Frequency	Channel	Frequency
00	2402 MHz	01	2404 MHz	02	2406 MHz	03	2408 MHz
04	2410 MHz	05	2412 MHz	06	2414 MHz	07	2416 MHz
08	2418 MHz	09	2420 MHz	10	2422 MHz	11	2424 MHz
12	2426 MHz	13	2428 MHz	14	2430 MHz	15	2432 MHz
16	2434 MHz	17	2436 MHz	18	2438 MHz	19	2440 MHz
20	2442 MHz	21	2444 MHz	22	2446 MHz	23	2448 MHz
24	2450 MHz	25	2452 MHz	26	2454 MHz	27	2456 MHz
28	2458 MHz	29	2460 MHz	30	2462 MHz	31	2464 MHz
32	2466 MHz	33	2468 MHz	34	2470 MHz	35	2472 MHz
36	2474 MHz	37	2476 MHz	38	2478 MHz	39	2480 MHz

2 DESCRIPTION OF TEST SETUP

2.1 Operating mode(s) used for tests

During the tests the following operating mode(s) has(have) been used.

Test Mode For Bluetooth	Mode1: Transmit by LE_1Mbps
	Mode2: Transmit by LE_2Mbps
	Mode3: Transmit by LE_Coded S=8
	Mode4: Transmit by LE_Coded S=2

2.2 Test Configuration / Block diagram used for tests

Test setup Diagram- AC Line Conducted Emission Test

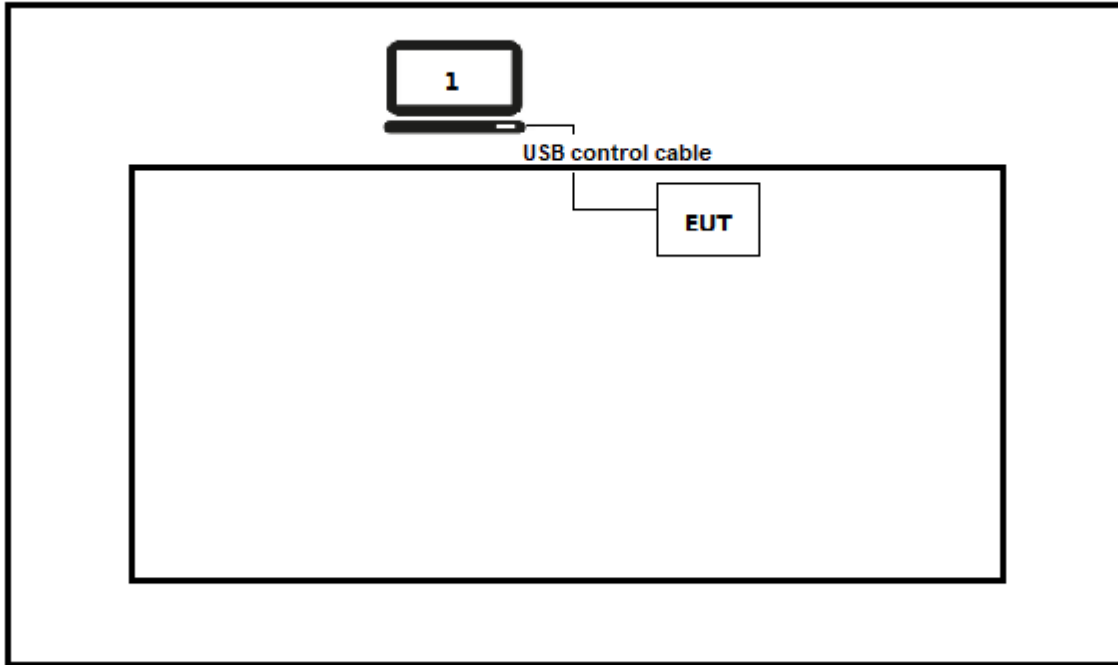

Test setup Diagram- Radiated Emission

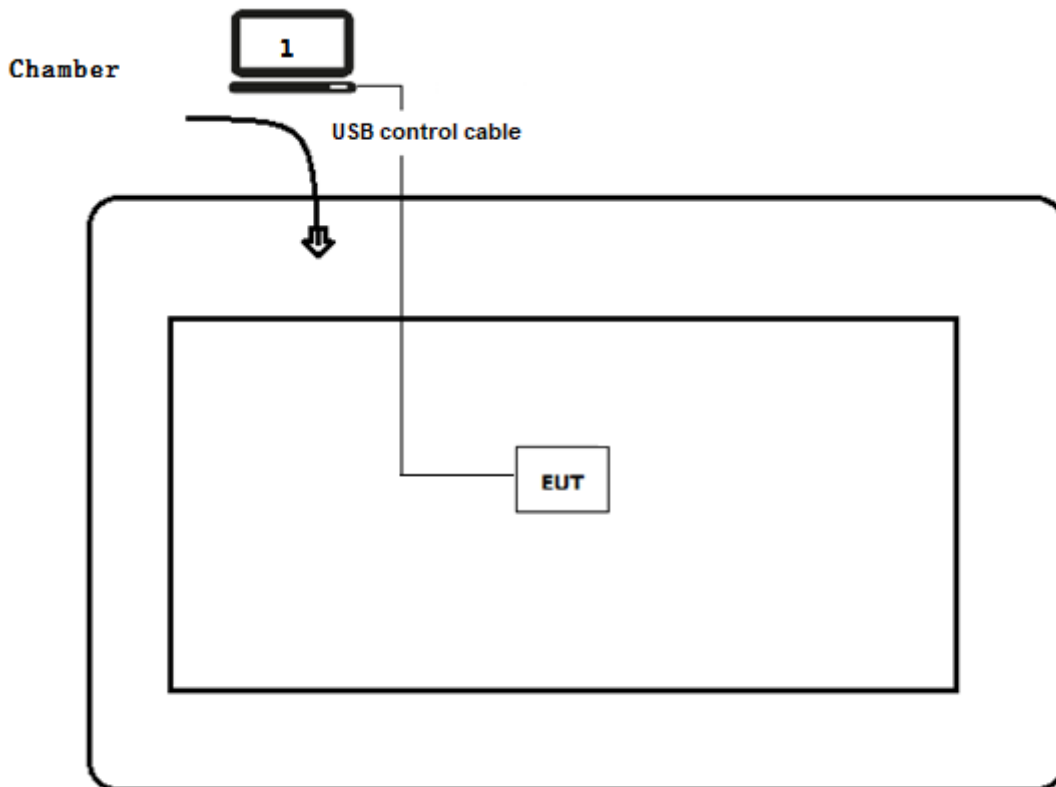

2.3 Testing process

1	Setup the EUT as shown in Section 2.2.
2	Execute Switch channel by repeating power on.
3	Configure the test mode, the test channel, and the data rate.
4	Verify that the EUT works properly.

3 VERDICT SUMMARY SECTION

This chapter presents an overview of standards and results. Refer to the next chapters for details of measured test results and applied test levels.

3.1 Standards

Standard	Year	Description
FCC CFR Title 47 Part 15 Subpart C Section 15.247	2019	Operation within the bands 902–928 MHz, 2400–2483.5 MHz, and 5725–5850 MHz.
ANSI C63.10	2013	American National Standard of Procedures for Compliance Testing of Unlicensed Wireless Devices
KDB 558074 D01 v05r02	2019	Guidance for performing compliance measurements on Digital Transmission System (DTS) operating under section 15.247
RSS-Gen Issue 5 Amendment 1	2019	General Requirements for Compliance of Radio Apparatus
RSS-247 Issue 2	2017	Digital Transmission Systems (DTSS), Frequency Hopping Systems (FHSs) and Licence-Exempt Local Area Network (LE-LAN) Devices

3.2 Deviation(s) from the Standard(s) / Test Specification(s)

The following deviation(s) was / were made from the published requirements of the listed standards: N/A.

(Please define the deviations from the standard(s) if applicable)

3.3 Overview of results

For FCC

Requirement – Test case	Basic standard(s)	Verdict	Remark
AC Power Line Conducted Emission	FCC 15.207	PASS	---
Emissions in restricted frequency bands	FCC 15.247(b)(3)	PASS	---
Duty cycle	ANSI C63.10:2013	PASS	---
Emissions in non-restricted frequency bands	FCC 15.247(d), FCC 15.209	PASS	---
Radiated Emission Band Edge	FCC 15.247(d)	PASS	---
Fundamental emission output power	FCC 15.247(d), FCC 15.209	PASS	---
DTS Bandwidth	FCC 15.247(a)(2)	PASS	---
Power Spectral Density	FCC 15.247(e)	PASS	---
Antenna Requirement	FCC 15.203	PASS	---

For ISED

Requirement – Test case	Basic standard(s)	Verdict	Remark
AC Power Line Conducted Emission	RSS-Gen Issue 5 Section 8.8	PASS	---
Emissions in restricted frequency bands	RSS-Gen Issue 5 Section 8.9	PASS	---
Duty cycle	ANSI C63.10:2013	PASS	---
Emissions in non-restricted frequency bands	RSS-247 Issue 2 Section 5.5	PASS	---
Radiated Emission Band Edge	RSS-Gen Issue 5 Section 8.10	PASS	---
Fundamental emission output power	RSS-247 Issue 2 Section 5.4(d)	PASS	---
DTS Bandwidth	RSS-Gen Issue 5 Section 6.7	PASS	---
Power Spectral Density	RSS-247 Issue 2 Section 5.2(b)	PASS	---
Antenna Requirement	RSS-Gen Issue 5 Section 6.8	PASS	---

3.4 Test Facility

USA	:	FCC Designation Number: CN1199
CA	:	ISED CAB identifier: CN0040

4 TEST RESULTS

4.1 AC Power Line Conducted Emission	VERDICT: PASS
---	----------------------

4.1.1 Limit

Standard	FCC Part 15 Subpart C Paragraph 15.207	
Frequency range [MHz]	Limit: QP [dB(μV) ¹⁾	Limit: AV [dB(μV) ¹⁾
0,15 - 0,50	66 - 56 ²⁾	56 - 46 ²⁾
0,50 - 5,0	56	46
5,0 - 30	60	50

¹⁾ At the transition frequency, the lower limit applies.

²⁾ The limit decreases linearly with the logarithm of the frequency.

NOTE 1: The exclusion band for transmitters shall be considered for transmitters operating at frequencies below 30 MHz.

NOTE 2: Where the AC output port is directly connected (or via a circuit breaker) to the AC power input port of the EUT the AC power output port need not to be tested.

4.1.2 Test Setup

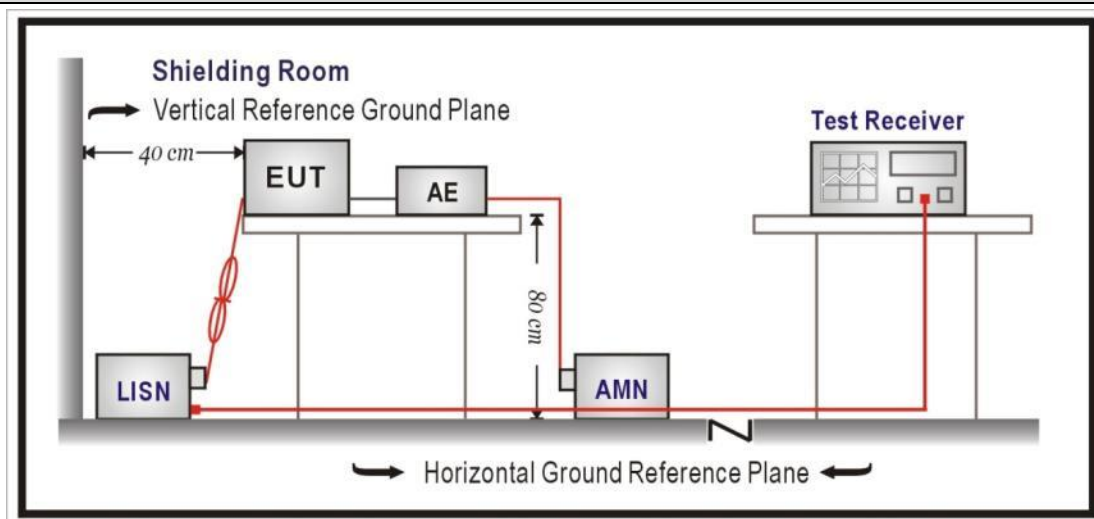

4.1.3 Test Procedure

	References Rule	Chapter	Item
<input checked="" type="checkbox"/>	ANSI C63.10-2013	6.2	Standard test method for ac power-line conducted emissions from unlicensed wireless devices

4.1.4 Test Data

Profile: 21B0246R	Page No.: 21
Engineer: Neil	
Site: TR1	Time: 2021/11/25
Limit: FCC_Part15.107_CE_AC Power_ClassB	Margin: 0
Probe: ENV216_101189(0.009-30MHz)	Polarity: Line
EUT: LED Device	Power: AC 120V/60Hz
Note: Modle1	

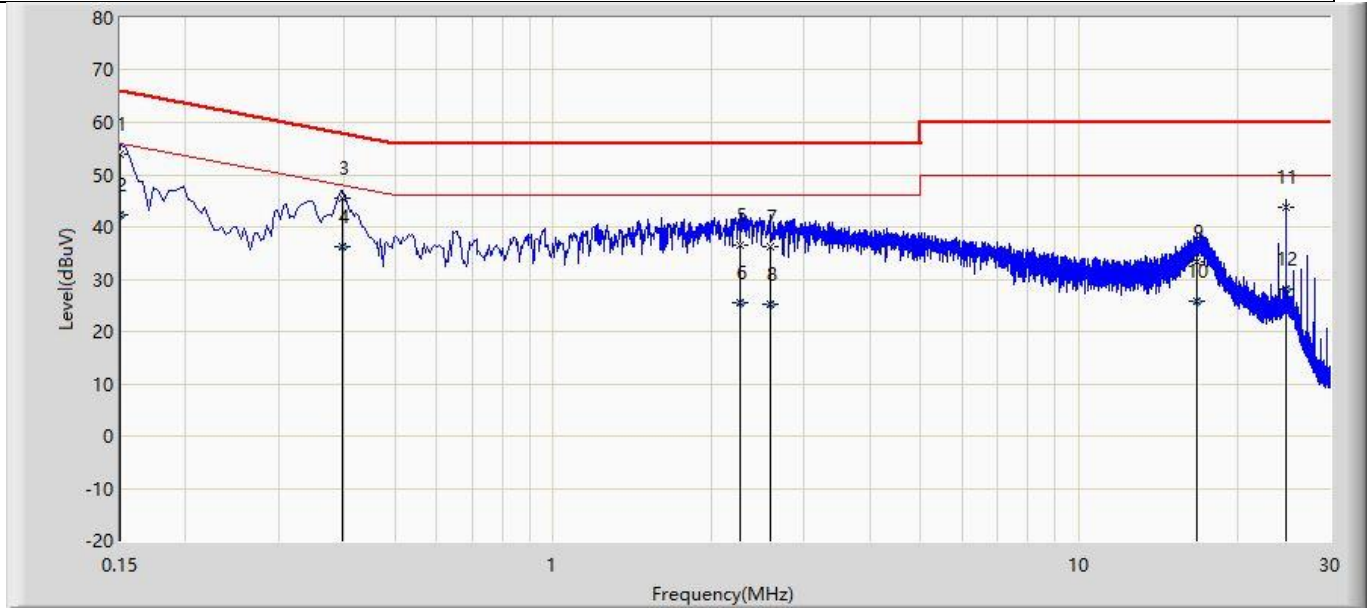

No	Mark	Frequency (MHz)	Measure Level (dBuV)	Reading Level (dBuV)	Over Limit (dB)	Limit (dBuV)	Probe (dB)	Cable (dB)	Amp (dB)	Type
1		0.150	54.036	44.370	-11.964	66.000	9.641	0.025	0.000	QP
2		0.150	42.431	32.764	-13.569	56.000	9.641	0.025	0.000	AV
3		0.398	45.373	35.691	-12.522	57.895	9.643	0.039	0.000	QP
4	*	0.398	36.188	26.507	-11.707	47.895	9.643	0.039	0.000	AV
5		2.262	36.642	26.904	-19.358	56.000	9.644	0.094	0.000	QP
6		2.262	25.448	15.711	-20.552	46.000	9.644	0.094	0.000	AV
7		2.582	36.209	26.457	-19.791	56.000	9.650	0.102	0.000	QP
8		2.582	25.222	15.471	-20.778	46.000	9.650	0.102	0.000	AV
9		16.754	33.329	23.152	-26.671	60.000	9.915	0.261	0.000	QP
10		16.754	25.721	15.545	-24.279	50.000	9.915	0.261	0.000	AV
11		24.802	43.653	33.188	-16.347	60.000	10.144	0.320	0.000	QP
12		24.802	28.096	17.632	-21.904	50.000	10.144	0.320	0.000	AV

Note:

1. " * ", means this data is the worst emission level.
2. Measurement Level = Reading Level + Factor(Probe+Cable-Amp).

Profile: 21B0246R	Page No.: 22
Engineer: Neil	
Site: TR1	Time: 2021/11/25
Limit: FCC_Part15.107_CE_AC Power_ClassB	Margin: 0
Probe: ENV216_101189(0.009-30MHz)	Polarity: Neutral
EUT: LED Device	Power: AC 120V/60Hz
Note: Modle1	

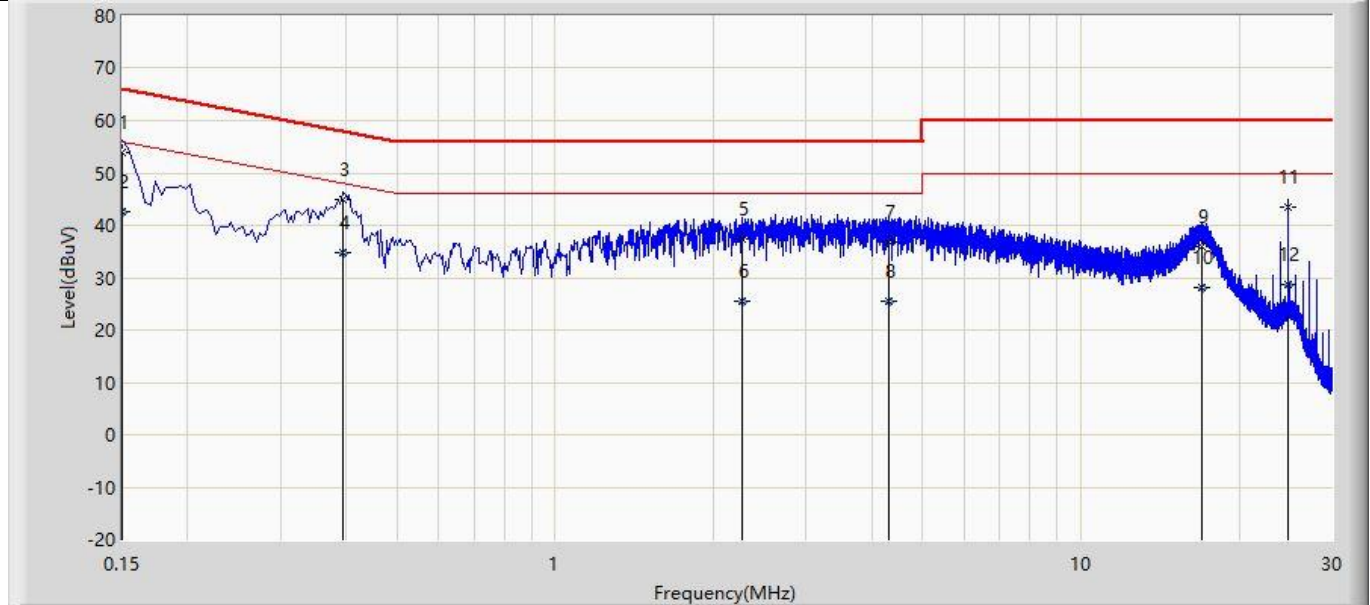

No	Mark	Frequency (MHz)	Measure Level (dBuV)	Reading Level (dBuV)	Over Limit (dB)	Limit (dBuV)	Probe (dB)	Cable (dB)	Amp (dB)	Type
1	*	0.150	53.992	44.337	-12.008	66.000	9.630	0.025	0.000	QP
2		0.150	42.504	32.849	-13.496	56.000	9.630	0.025	0.000	AV
3		0.394	44.844	35.186	-13.135	57.979	9.620	0.039	0.000	QP
4		0.394	34.646	24.987	-13.333	47.979	9.620	0.039	0.000	AV
5		2.266	37.472	27.744	-18.528	56.000	9.634	0.094	0.000	QP
6		2.266	25.488	15.760	-20.512	46.000	9.634	0.094	0.000	AV
7		4.314	36.746	26.946	-19.254	56.000	9.669	0.132	0.000	QP
8		4.314	25.602	15.801	-20.398	46.000	9.669	0.132	0.000	AV
9		16.974	35.905	25.752	-24.095	60.000	9.890	0.263	0.000	QP
10		16.974	28.195	18.042	-21.805	50.000	9.890	0.263	0.000	AV
11		24.798	43.378	32.897	-16.622	60.000	10.160	0.320	0.000	QP
12		24.798	28.659	18.178	-21.341	50.000	10.160	0.320	0.000	AV

Note:

1. " * ", means this data is the worst emission level.
2. Measurement Level = Reading Level + Factor(Probe+Cable-Amp).

4.2 Emissions in restricted frequency bands	VERDICT: PASS
--	----------------------

4.2.1 Limit

Standard	FCC Part 15 Subpart C Paragraph 15.209
-----------------	--

Restricted Bands of operation

Frequency (MHz)	Frequency (MHz)	Frequency (MHz)	Frequency (GHz)
0.090 – 0.110	16.42 – 16.423	399.9 – 410	4.5 – 5.15
0.495 – 0.505	16.69475 – 16.69525	608 – 614	5.35 – 5.46
2.1735 – 2.1905	16.80425 – 16.80475	960 – 1240	7.25 – 7.75
4.125 – 4.128	25.5 – 25.67	1300 – 1427	8.025 – 8.5
4.17725 – 4.17775	37.5 – 38.25	1435 – 1626.5	9.0 – 9.2
4.20725 – 4.20775	73 – 74.6	1645.5 – 1646.5	9.3 – 9.5
6.215 – 6.218	74.8 – 75.2	1660 – 1710	10.6 – 12.7
6.26775 – 6.26825	108 – 121.94	1718.8 – 1722.2	13.25 – 13.4
6.31175 – 6.31225	123 – 138	2200 – 2300	14.47 – 14.5
8.291 – 8.294	149.9 – 150.05	2310 – 2390	15.35 – 16.2
8.362 – 8.366	156.52475 – 156.52525	2483.5 – 2500	17.7 – 21.4
8.37625 – 8.38675	156.7 – 156.9	2690 – 2900	22.01 – 23.12
8.81425 – 8.81475	162.0125 – 167.17	3260 – 3267	23.6 – 24.0
12.29 – 12.293	167.72 – 173.2	3332 – 3339	31.2 – 31.8
12.51975 – 12.52025	240 – 285	3345.8 – 3358	36.43 – 36.5
12.57675 – 12.57725	322 – 335.4	3600 – 4400	
13.36 – 13.41			

Restricted Bands of operation for IC

0.090 - 0.110	13.36 - 13.41	960 - 1427	9.0 - 9.2
0.495 - 0.505	16.42 - 16.423	1435 - 1626.5	9.3 - 9.5
2.1735 - 2.1905	16.69475 - 16.69525	1645.5 - 1646.5	10.6 - 12.7
3.020 - 3.026	16.80425 - 16.80475	1660 - 1710	13.25 - 13.4
4.125 - 4.128	25.5 - 25.67	1718.8 - 1722.2	14.47 - 14.5
4.17725 - 4.17775	37.5 - 38.25	2200 - 2300	15.35 - 16.2
4.20725 - 4.20775	73 - 74.6	2310 - 2390	17.7 - 21.4
5.677 - 5.683	74.8 - 75.2	2483.5 - 2500	22.01 - 23.12
6.215 - 6.218	108 - 138	2655 - 2900	23.6 - 24.0
6.26775 - 6.26825	149.9 - 150.05	3260 - 3267	31.2 - 31.8
6.31175 - 6.31225	156.52475 - 156.52525	3332 - 3339	36.43 - 36.5
8.291 - 8.294	156.7 - 156.9	3345.8 - 3358	Above 38.6
8.362 - 8.366	162.0125 - 167.17	3500 - 4400	
8.37625 - 8.38675	167.72 - 173.2	4500 - 5150	
8.41425 - 8.41475	240 - 285	5350 - 5460	
12.29 - 12.293	322 - 335.4	7250 - 7750	
12.51975 - 12.52025	399.9 - 410	8025 - 8500	
12.57675 - 12.57725	608 - 614	--	

Restricted Band Emissions Limit			
Frequency (MHz)	Field strength ($\mu\text{V}/\text{m}$)	Field strength ($\text{dB}\mu\text{V}/\text{m}$)	Measurement distance (m)
0.009 - 0.49	2400/F(kHz)	48.5 – 13.8	300 _(Note 1)
0.49 - 1.705	24000/F(kHz)	33.8 - 23	30 _(Note 1)
1.705 - 30	30	29.5	30 _(Note 1)
30 - 88	100	40	3 _(Note 2)
88 - 216	150	43.5	3 _(Note 2)
216 - 960	200	46	3 _(Note 2)
Above 960	500	54	3 _(Note 2)

Note 1: At frequencies below 30 MHz, measurements may be performed at a distance closer than that specified in the regulations; however, an attempt should be made to avoid making measurements in the near field. Pending the development of an appropriate measurement procedure for measurements performed below 30 MHz, when performing measurements at a closer distance than specified, the results shall be extrapolated to the specified distance by either making measurements at a minimum of two distances on at least one radial to determine the proper extrapolation factor or by using the square of an inverse linear distance extrapolation factor (40 dB/decade).

Note 2: At frequencies at or above 30 MHz, measurements may be performed at a distance other than what is specified provided: measurements are not made in the near field except where it can be shown that near field measurements are appropriate due to the characteristics of the device; and it can be demonstrated that the signal levels needed to be measured at the distance employed can be detected by the measurement equipment.

Measurements shall not be performed at a distance greater than 30 meters unless it can be further demonstrated that measurements at a distance of 30 meters or less are impractical. When performing measurements at a distance other than that specified, the results shall be extrapolated to the specified distance using an extrapolation factor of 20 dB/decade (inverse linear-distance for field strength measurements; inverse-linear-distance-squared for power density measurements).

4.2.2 Test Setup

30MHz-1GHz Test Setup:

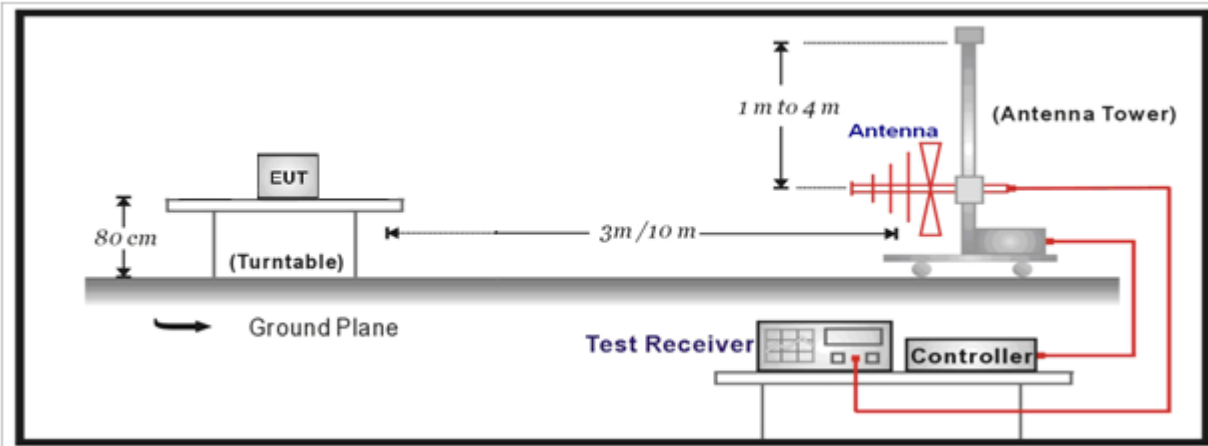

Above 1GHz Test Setup:

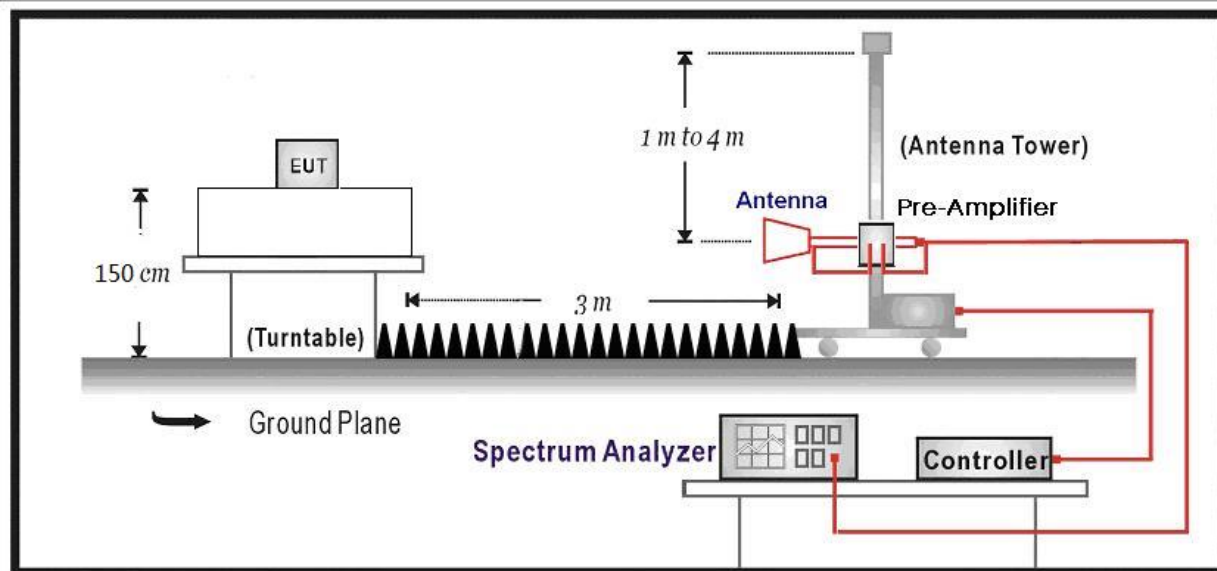

4.2.3 Test Procedure

References Rule	Chapter	Description
<input checked="" type="checkbox"/> ANSI C63.10	11.12	Emissions in restricted frequency bands
<input checked="" type="checkbox"/> ANSI C63.10	11.12.1	Radiated emission measurements
<input checked="" type="checkbox"/> ANSI C63.10	11.12.2.7	Radiated spurious emission test
<input checked="" type="checkbox"/> ANSI C63.10	6.4	Radiated emissions from unlicensed wireless devices below 30 MHz
<input checked="" type="checkbox"/> ANSI C63.10	6.5	Radiated emissions from unlicensed wireless devices in the frequency range of 30 MHz to 1000 MHz
<input checked="" type="checkbox"/> ANSI C63.10	6.6	Radiated emissions from unlicensed wireless devices above 1 GHz

4.2.4 Test Data

Profile: 21B0246R	Page No.: 31
Engineer: Neil	
Site: AC5	Time: 2021/11/11 - 21:00
Limit: FCC_Part15.209_RE(3m)	Margin: 0
Probe: Horn_3117_00123988_(1-18GHz)	Polarity: Horizontal
EUT: LED DEVICE	Power: AC 120V/60Hz
Note: Mode 1:Transmit at 2402MHz by BLE	

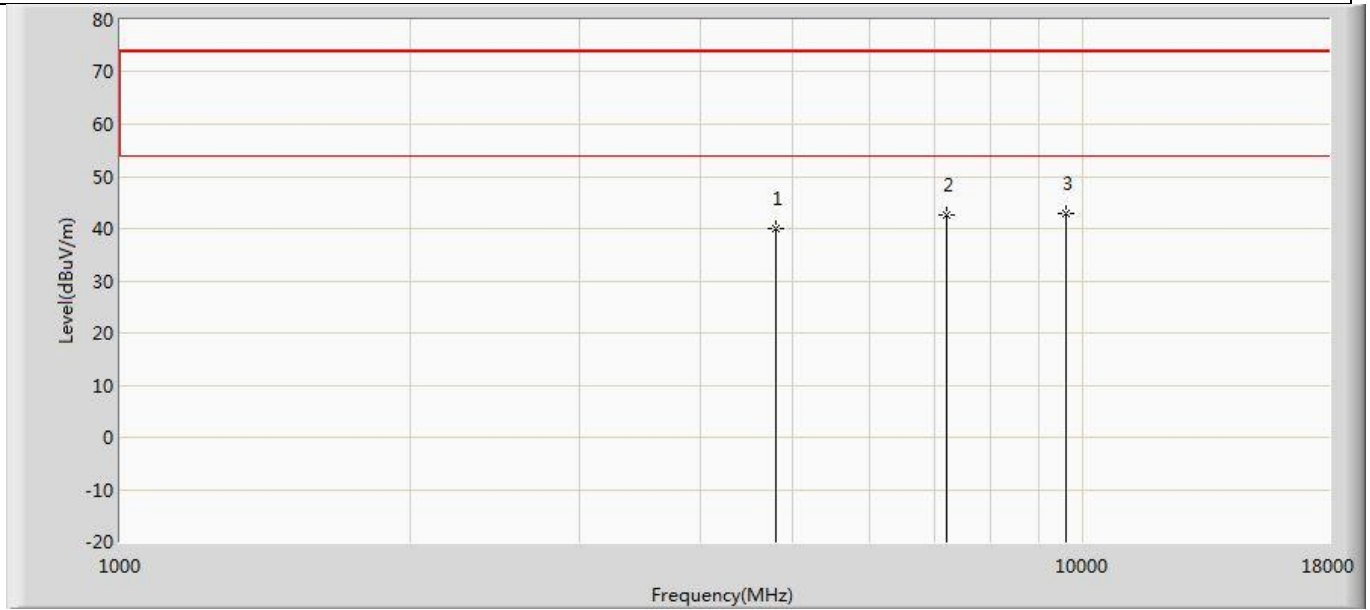

No	Mark	Frequency (MHz)	Measure Level (dBuV/m)	Reading Level (dBuV)	Over Limit (dB)	Limit (dBuV/m)	Factor (dB)	Type
1		4804.000	39.904	34.282	-34.096	74.000	5.621	PK
2		7206.000	42.531	33.463	-31.469	74.000	9.068	PK
3	*	9608.000	42.958	29.873	-31.042	74.000	13.084	PK

Profile: 21B0246R	Page No.: 32
Engineer: Neil	
Site: AC5	Time: 2021/11/11 - 21:00
Limit: FCC_Part15.209_RE(3m)	Margin: 0
Probe: Horn_3117_00123988_(1-18GHz)	Polarity: Vertical
EUT: LED DEVICE	Power: AC 120V/60Hz
Note: Mode 1:Transmit at 2402MHz by BLE	

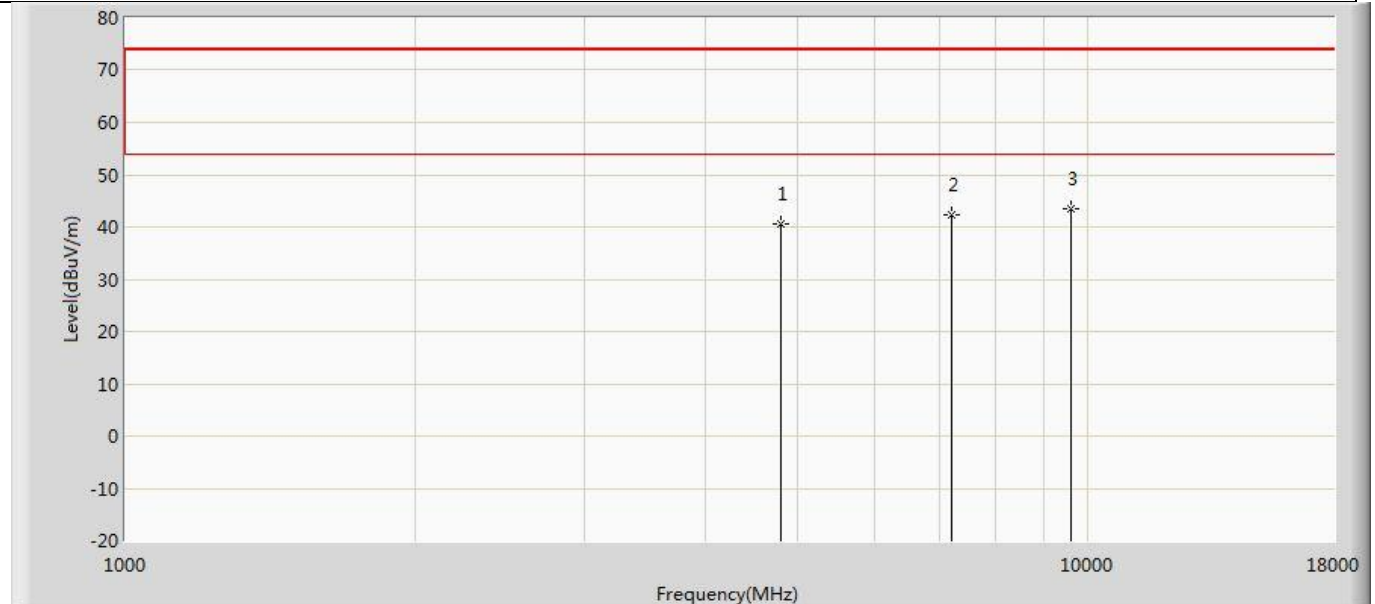

No	Mark	Frequency (MHz)	Measure Level (dBuV/m)	Reading Level (dBuV)	Over Limit (dB)	Limit (dBuV/m)	Factor (dB)	Type
1		4804.000	40.681	35.059	-33.319	74.000	5.621	PK
2		7206.000	42.304	33.236	-31.696	74.000	9.068	PK
3	*	9608.000	43.536	30.451	-30.464	74.000	13.084	PK

Profile: 21B0246R	Page No.: 33
Engineer: Neil	
Site: AC5	Time: 2021/11/11 - 21:00
Limit: FCC_Part15.209_RE(3m)	Margin: 0
Probe: Horn_3117_00123988_(1-18GHz)	Polarity: Horizontal
EUT: LED DEVICE	Power: AC 120V/60Hz
Note: Mode 1:Transmit at 2440MHz by BLE	

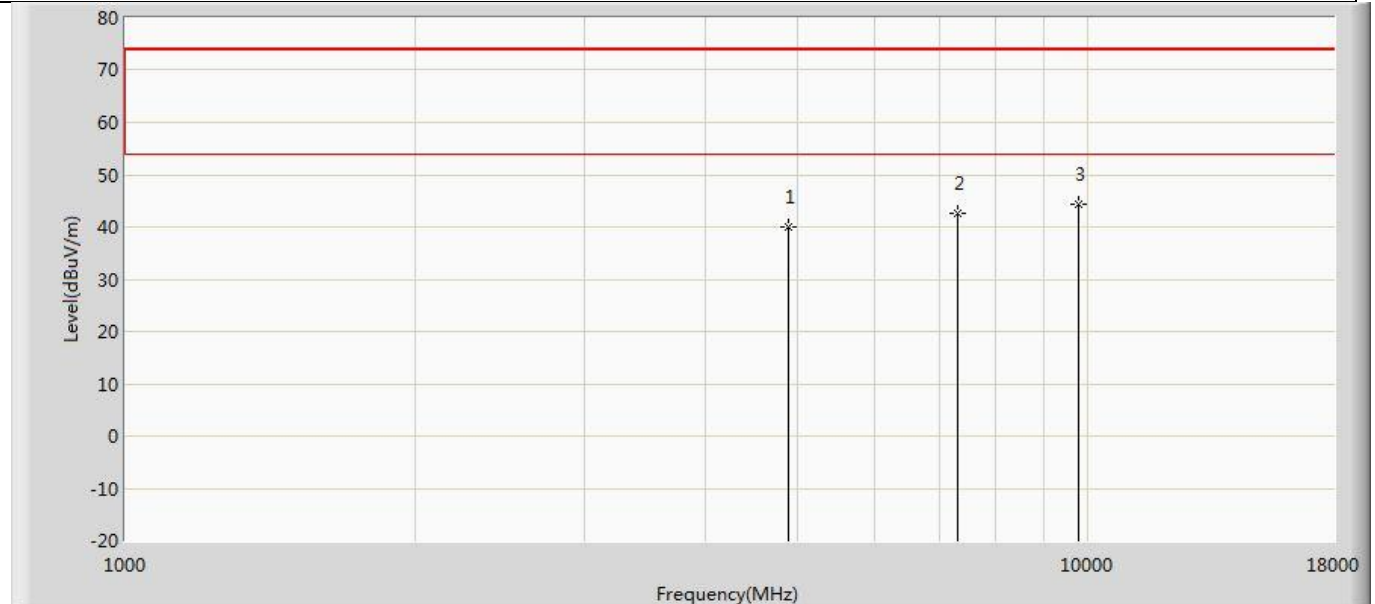

No	Mark	Frequency (MHz)	Measure Level (dBuV/m)	Reading Level (dBuV)	Over Limit (dB)	Limit (dBuV/m)	Factor (dB)	Type
1		4880.000	40.021	34.102	-33.979	74.000	5.919	PK
2		7320.000	42.669	33.163	-31.331	74.000	9.506	PK
3	*	9760.000	44.428	31.374	-29.572	74.000	13.054	PK

Profile: 21B0246R	Page No.: 34
Engineer: Neil	
Site: AC5	Time: 2021/11/11 - 21:00
Limit: FCC_Part15.209_RE(3m)	Margin: 0
Probe: Horn_3117_00123988_(1-18GHz)	Polarity: Vertical
EUT: LED DEVICE	Power: AC 120V/60Hz
Note: Mode 1:Transmit at 2440MHz by BLE	

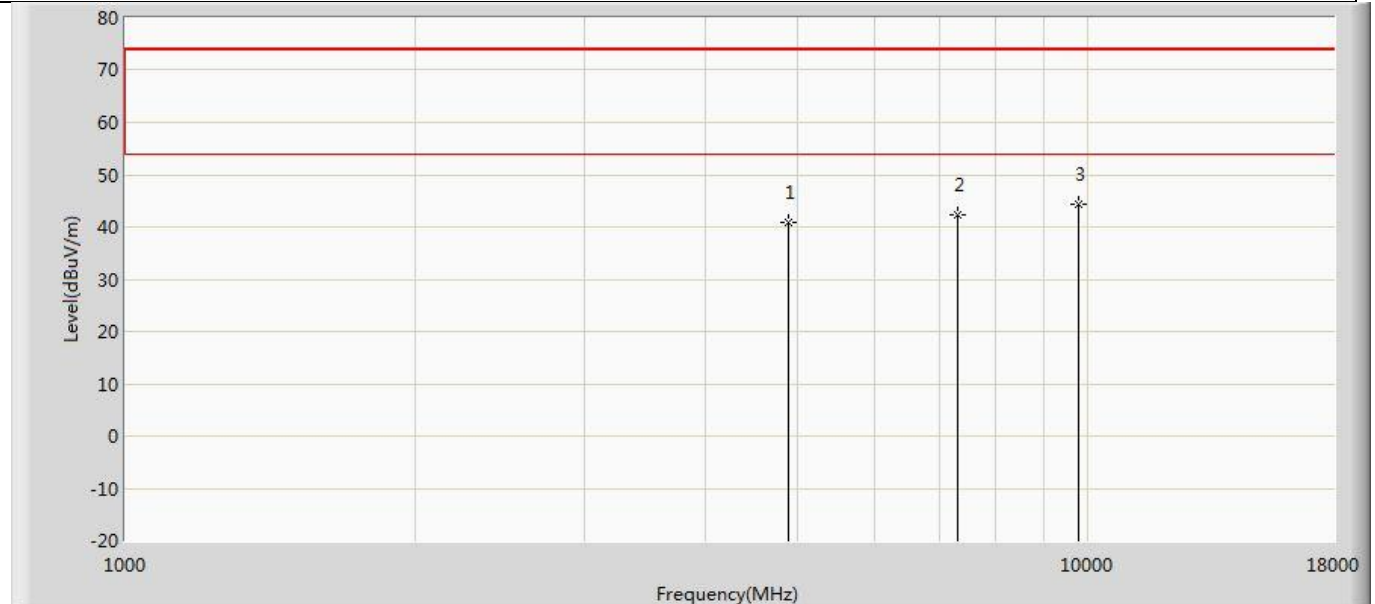

No	Mark	Frequency (MHz)	Measure Level (dBuV/m)	Reading Level (dBuV)	Over Limit (dB)	Limit (dBuV/m)	Factor (dB)	Type
1		4880.000	40.940	35.021	-33.060	74.000	5.919	PK
2		7320.000	42.363	32.857	-31.637	74.000	9.506	PK
3	*	9760.000	44.321	31.267	-29.679	74.000	13.054	PK

Profile: 21B0246R	Page No.: 35
Engineer: Neil	
Site: AC5	Time: 2021/11/11 - 21:00
Limit: FCC_Part15.209_RE(3m)	Margin: 0
Probe: Horn_3117_00123988_(1-18GHz)	Polarity: Horizontal
EUT: LED DEVICE	Power: AC 120V/60Hz
Note: Mode 1:Transmit at 2480MHz by BLE	

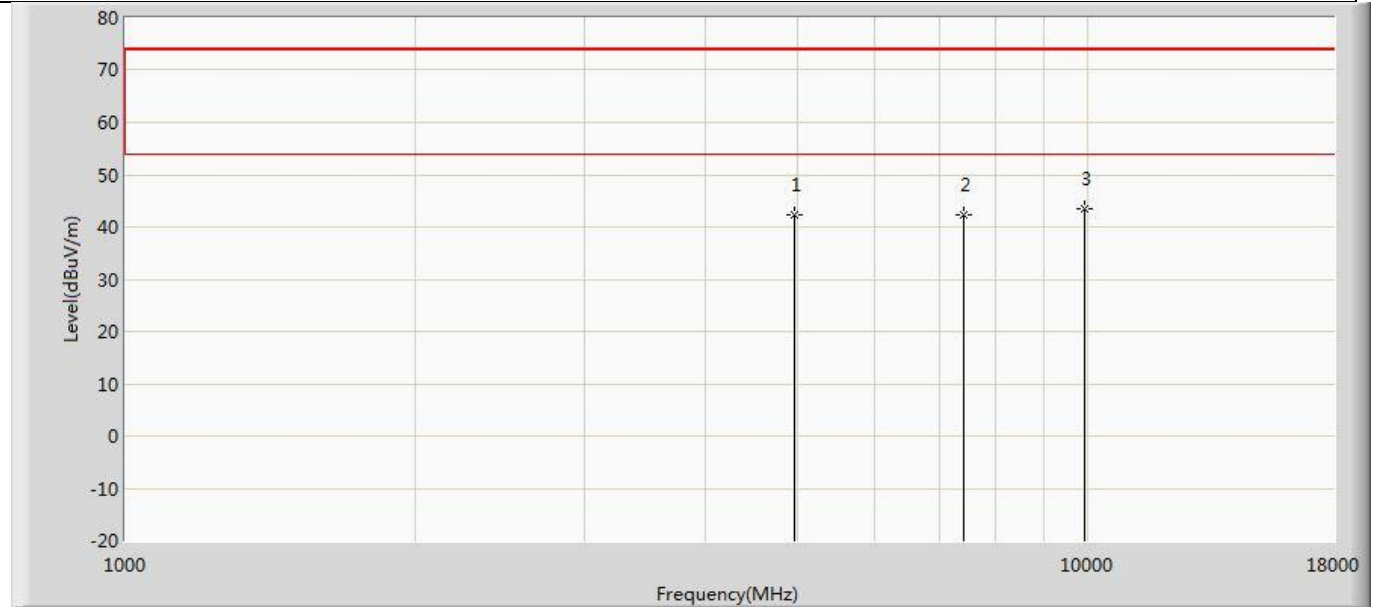

No	Mark	Frequency (MHz)	Measure Level (dBuV/m)	Reading Level (dBuV)	Over Limit (dB)	Limit (dBuV/m)	Factor (dB)	Type
1		4960.000	42.183	36.205	-31.817	74.000	5.978	PK
2		7440.000	42.245	32.718	-31.755	74.000	9.526	PK
3	*	9920.000	43.527	30.540	-30.473	74.000	12.986	PK

Profile: 21B0246R	Page No.: 36
Engineer: Neil	
Site: AC5	Time: 2021/11/11 - 21:00
Limit: FCC_Part15.209_RE(3m)	Margin: 0
Probe: Horn_3117_00123988_(1-18GHz)	Polarity: Vertical
EUT: LED DEVICE	Power: AC 120V/60Hz
Note: Mode 1:Transmit at 2480MHz by BLE	

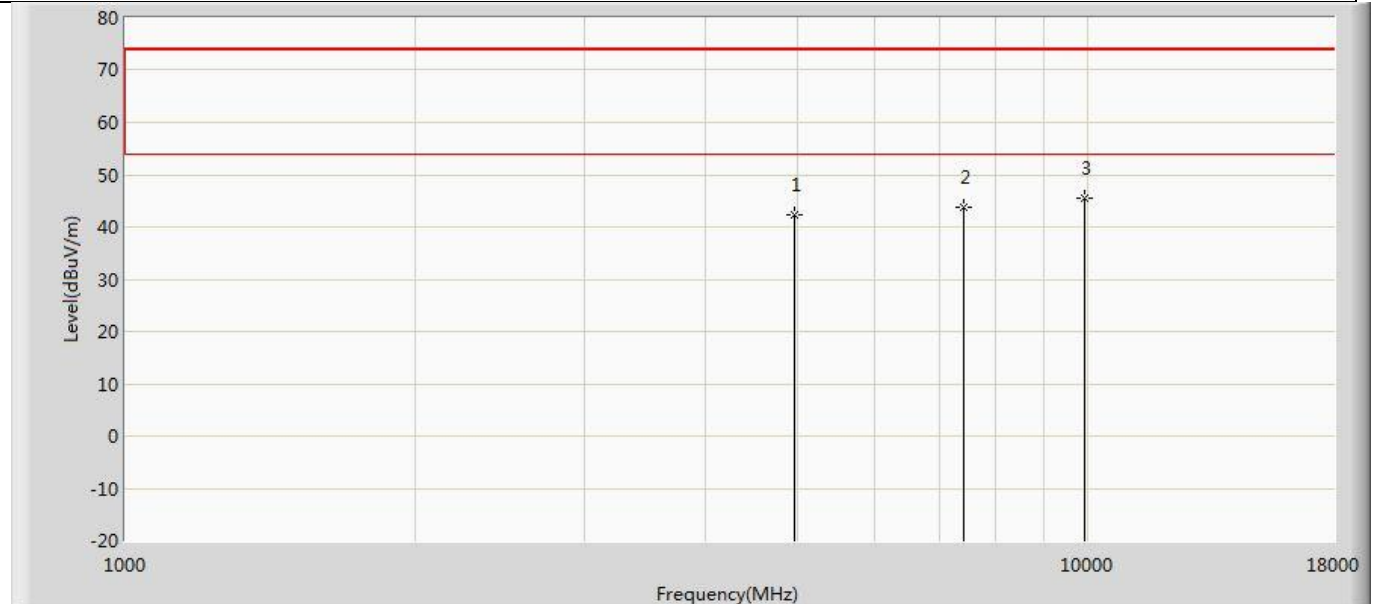

No	Mark	Frequency (MHz)	Measure Level (dBuV/m)	Reading Level (dBuV)	Over Limit (dB)	Limit (dBuV/m)	Factor (dB)	Type
1		4960.000	42.462	36.484	-31.538	74.000	5.978	PK
2		7440.000	43.758	34.231	-30.242	74.000	9.526	PK
3	*	9920.000	45.467	32.480	-28.533	74.000	12.986	PK

Profile: 21B0246R	Page No.: 37
Engineer: Neil	
Site: AC5	Time: 2021/11/11 - 21:00
Limit: FCC_Part15.209_RE(3m)	Margin: 0
Probe: Horn_3117_00123988_(1-18GHz)	Polarity: Horizontal
EUT: LED DEVICE	Power: AC 120V/60Hz
Note: Mode 2:Transmit at 2402MHz by 2LE	

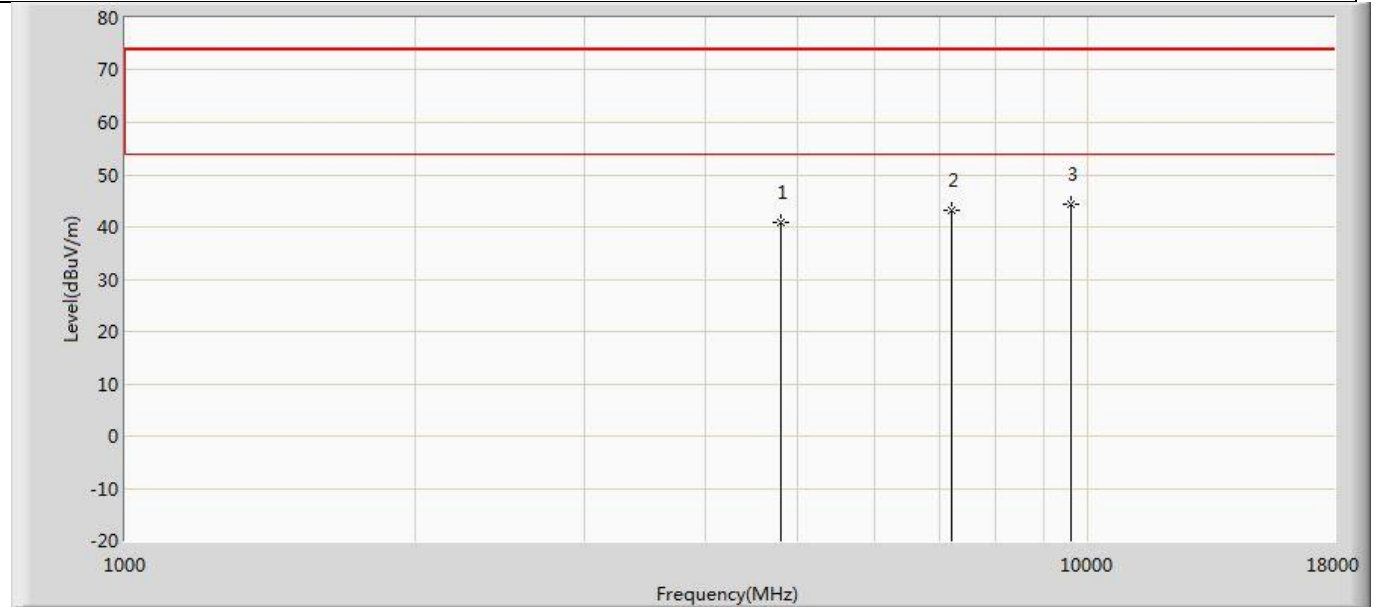

No	Mark	Frequency (MHz)	Measure Level (dBuV/m)	Reading Level (dBuV)	Over Limit (dB)	Limit (dBuV/m)	Factor (dB)	Type
1		4804.000	40.982	35.360	-33.018	74.000	5.621	PK
2		7206.000	43.290	34.222	-30.710	74.000	9.068	PK
3	*	9608.000	44.398	31.313	-29.602	74.000	13.084	PK

Profile: 21B0246R	Page No.: 38
Engineer: Neil	
Site: AC5	Time: 2021/11/11 - 21:00
Limit: FCC_Part15.209_RE(3m)	Margin: 0
Probe: Horn_3117_00123988_(1-18GHz)	Polarity: Vertical
EUT: LED DEVICE	Power: AC 120V/60Hz
Note: Mode 2:Transmit at 2402MHz by 2LE	

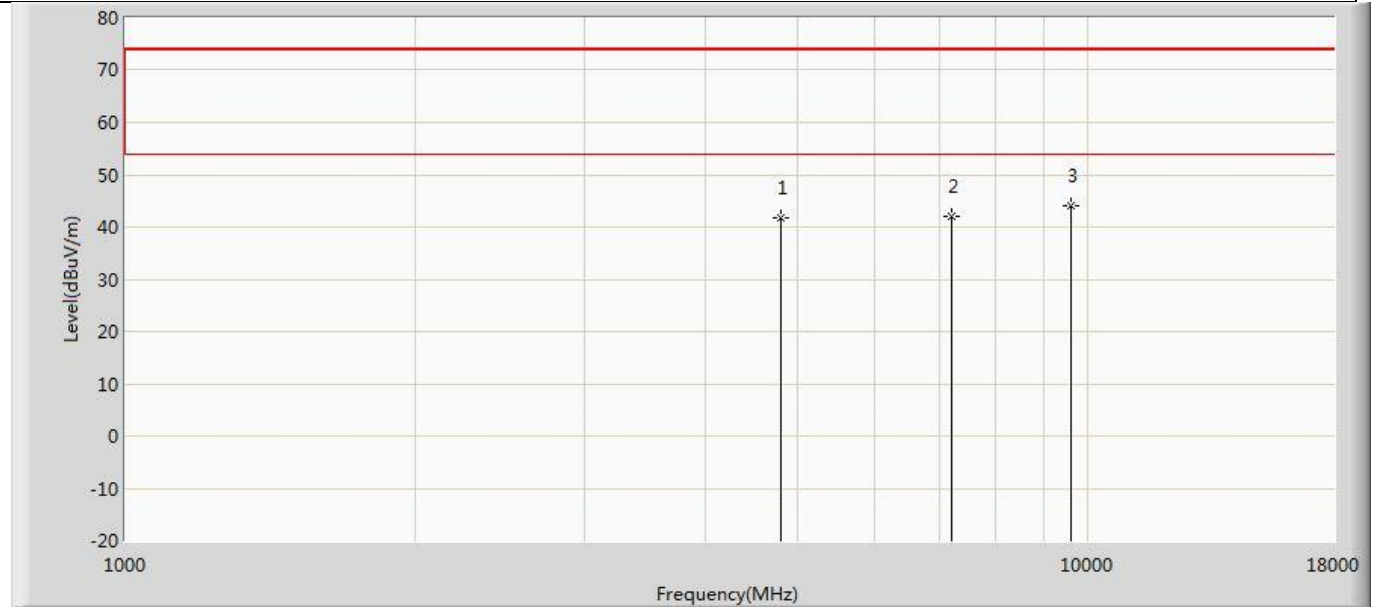

No	Mark	Frequency (MHz)	Measure Level (dBuV/m)	Reading Level (dBuV)	Over Limit (dB)	Limit (dBuV/m)	Factor (dB)	Type
1		4804.000	41.838	36.216	-32.162	74.000	5.621	PK
2		7206.000	41.960	32.892	-32.040	74.000	9.068	PK
3	*	9608.000	44.143	31.058	-29.857	74.000	13.084	PK

Profile: 21B0246R	Page No.: 39
Engineer: Neil	
Site: AC5	Time: 2021/11/11 - 21:00
Limit: FCC_Part15.209_RE(3m)	Margin: 0
Probe: Horn_3117_00123988_(1-18GHz)	Polarity: Horizontal
EUT: LED DEVICE	Power: AC 120V/60Hz
Note: Mode 2:Transmit at 2440MHz by 2LE	

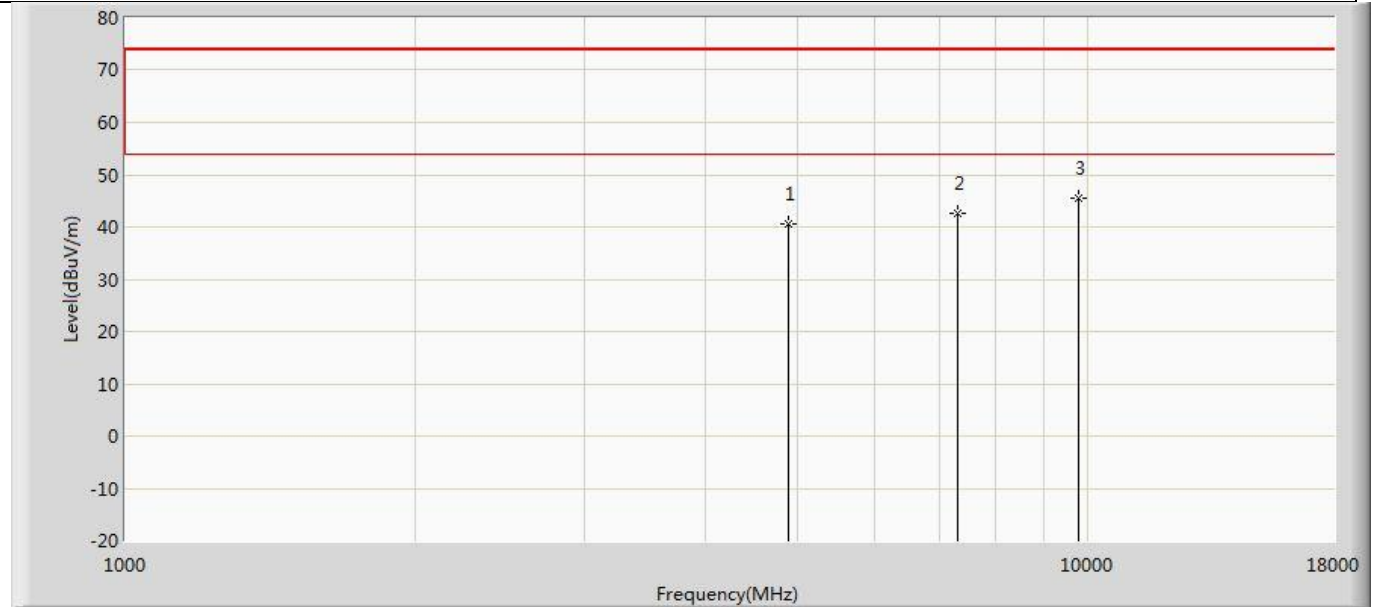

No	Mark	Frequency (MHz)	Measure Level (dBuV/m)	Reading Level (dBuV)	Over Limit (dB)	Limit (dBuV/m)	Factor (dB)	Type
1		4880.000	40.537	34.618	-33.463	74.000	5.919	PK
2		7320.000	42.578	33.072	-31.422	74.000	9.506	PK
3	*	9760.000	45.604	32.550	-28.396	74.000	13.054	PK

Profile: 21B0246R	Page No.: 40
Engineer: Neil	
Site: AC5	Time: 2021/11/11 - 21:00
Limit: FCC_Part15.209_RE(3m)	Margin: 0
Probe: Horn_3117_00123988_(1-18GHz)	Polarity: Vertical
EUT: LED DEVICE	Power: AC 120V/60Hz
Note: Mode 2:Transmit at 2440MHz by 2LE	

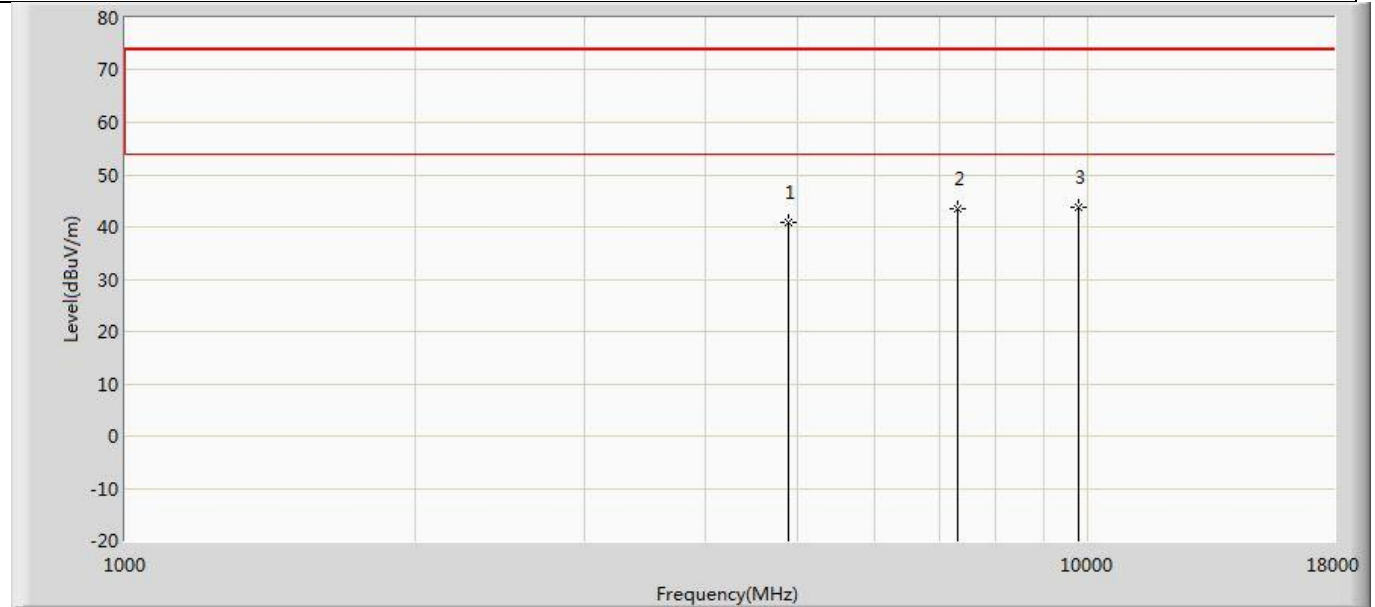

No	Mark	Frequency (MHz)	Measure Level (dBuV/m)	Reading Level (dBuV)	Over Limit (dB)	Limit (dBuV/m)	Factor (dB)	Type
1		4880.000	40.864	34.945	-33.136	74.000	5.919	PK
2		7320.000	43.508	34.002	-30.492	74.000	9.506	PK
3	*	9760.000	43.714	30.660	-30.286	74.000	13.054	PK

Profile: 21B0246R	Page No.: 41
Engineer: Neil	
Site: AC5	Time: 2021/11/11 - 21:00
Limit: FCC_Part15.209_RE(3m)	Margin: 0
Probe: Horn_3117_00123988_(1-18GHz)	Polarity: Horizontal
EUT: LED DEVICE	Power: AC 120V/60Hz
Note: Mode 2:Transmit at 2480MHz by 2LE	

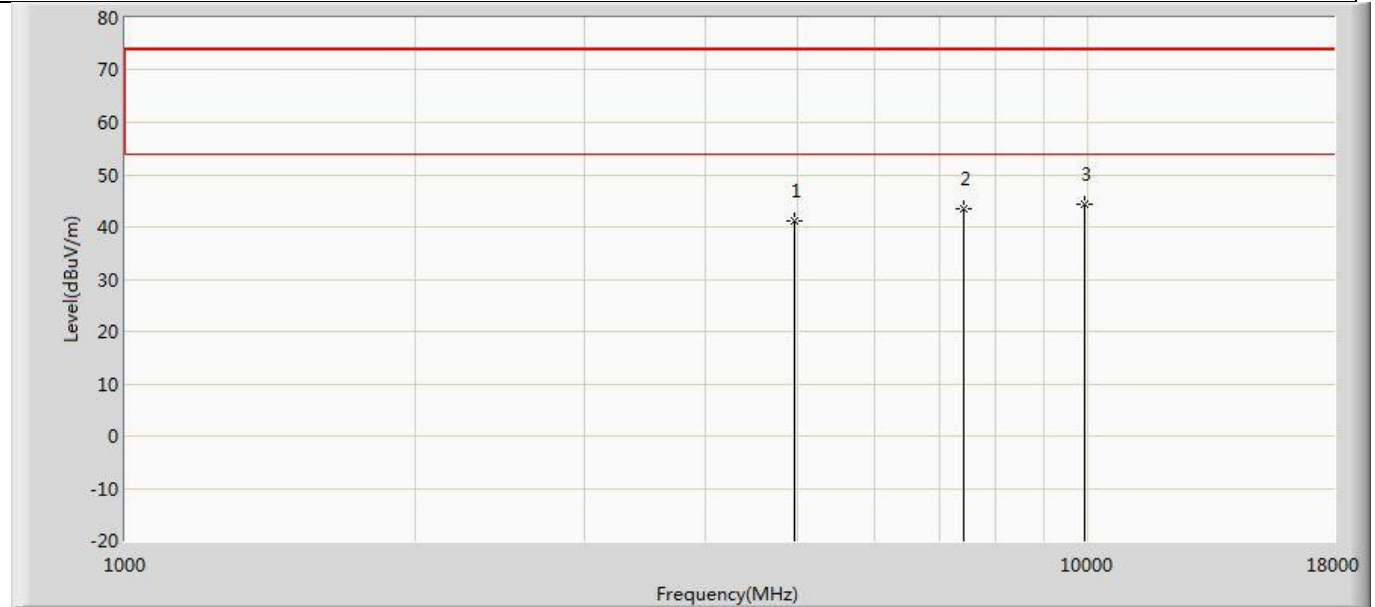

No	Mark	Frequency (MHz)	Measure Level (dBuV/m)	Reading Level (dBuV)	Over Limit (dB)	Limit (dBuV/m)	Factor (dB)	Type
1		4960.000	41.139	35.161	-32.861	74.000	5.978	PK
2		7440.000	43.392	33.865	-30.608	74.000	9.526	PK
3	*	9920.000	44.235	31.248	-29.765	74.000	12.986	PK

Profile: 21B0246R	Page No.: 42
Engineer: Neil	
Site: AC5	Time: 2021/11/11 - 21:00
Limit: FCC_Part15.209_RE(3m)	Margin: 0
Probe: Horn_3117_00123988_(1-18GHz)	Polarity: Vertical
EUT: LED DEVICE	Power: AC 120V/60Hz
Note: Mode 2:Transmit at 2480MHz by 2LE	

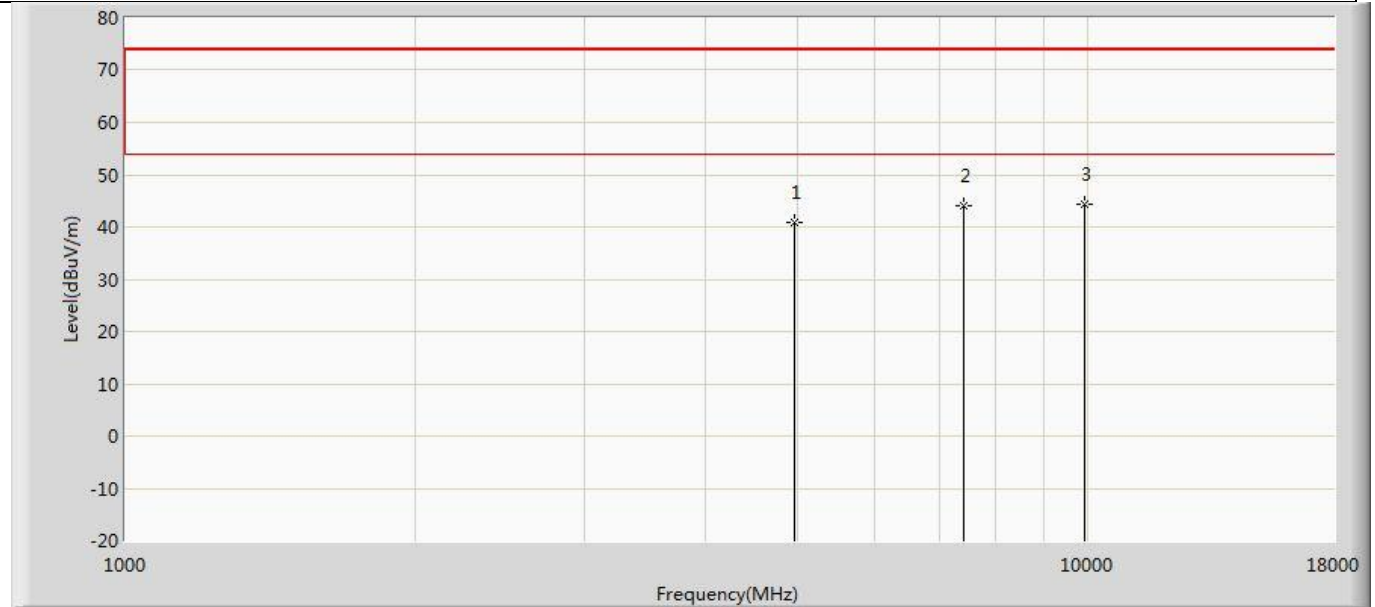

No	Mark	Frequency (MHz)	Measure Level (dBuV/m)	Reading Level (dBuV)	Over Limit (dB)	Limit (dBuV/m)	Factor (dB)	Type
1		4960.000	40.738	34.760	-33.262	74.000	5.978	PK
2		7440.000	44.175	34.648	-29.825	74.000	9.526	PK
3	*	9920.000	44.236	31.249	-29.764	74.000	12.986	PK

Profile: 21B0246R	Page No.: 43
Engineer: Neil	
Site: AC5	Time: 2021/11/11 - 21:00
Limit: FCC_Part15.209_RE(3m)	Margin: 0
Probe: Horn_3117_00123988_(1-18GHz)	Polarity: Horizontal
EUT: LED DEVICE	Power: AC 120V/60Hz
Note: Mode 3:Transmit at 2402MHz by 125k	

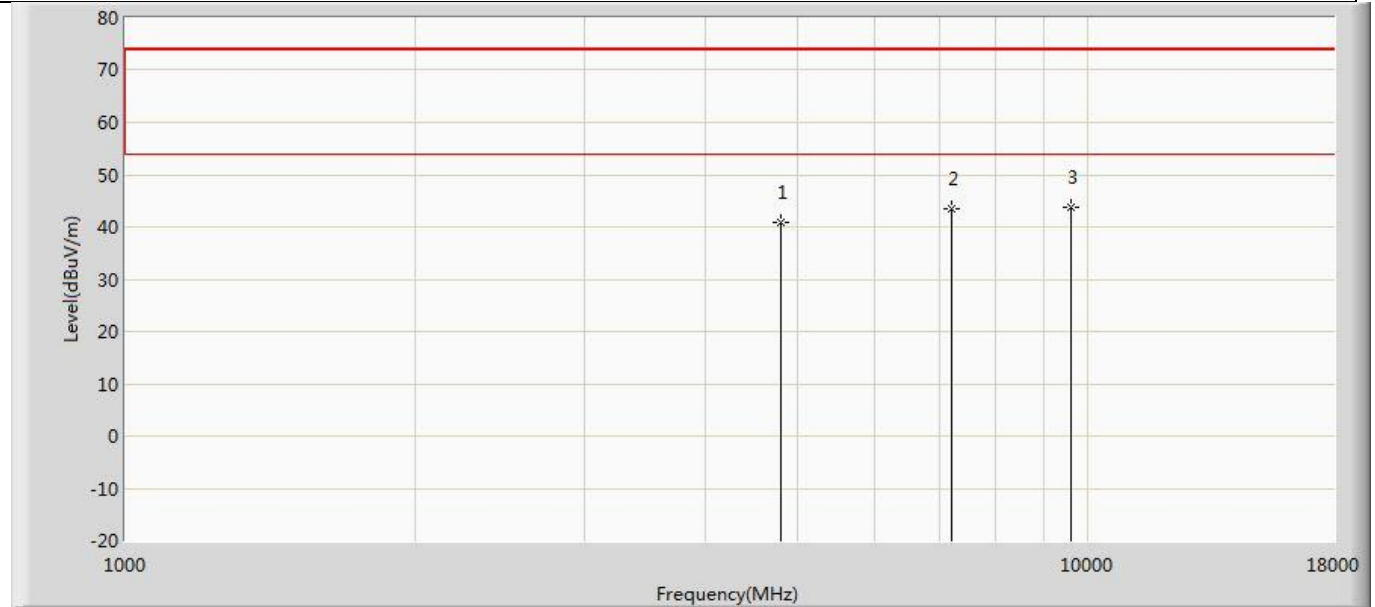

No	Mark	Frequency (MHz)	Measure Level (dBuV/m)	Reading Level (dBuV)	Over Limit (dB)	Limit (dBuV/m)	Factor (dB)	Type
1		4804.000	40.968	35.346	-33.032	74.000	5.621	PK
2		7206.000	43.338	34.270	-30.662	74.000	9.068	PK
3	*	9608.000	43.653	30.568	-30.347	74.000	13.084	PK

Profile: 21B0246R	Page No.: 44
Engineer: Neil	
Site: AC5	Time: 2021/11/11 - 21:00
Limit: FCC_Part15.209_RE(3m)	Margin: 0
Probe: Horn_3117_00123988_(1-18GHz)	Polarity: Vertical
EUT: LED DEVICE	Power: AC 120V/60Hz
Note: Mode 3:Transmit at 2402MHz by 125k	

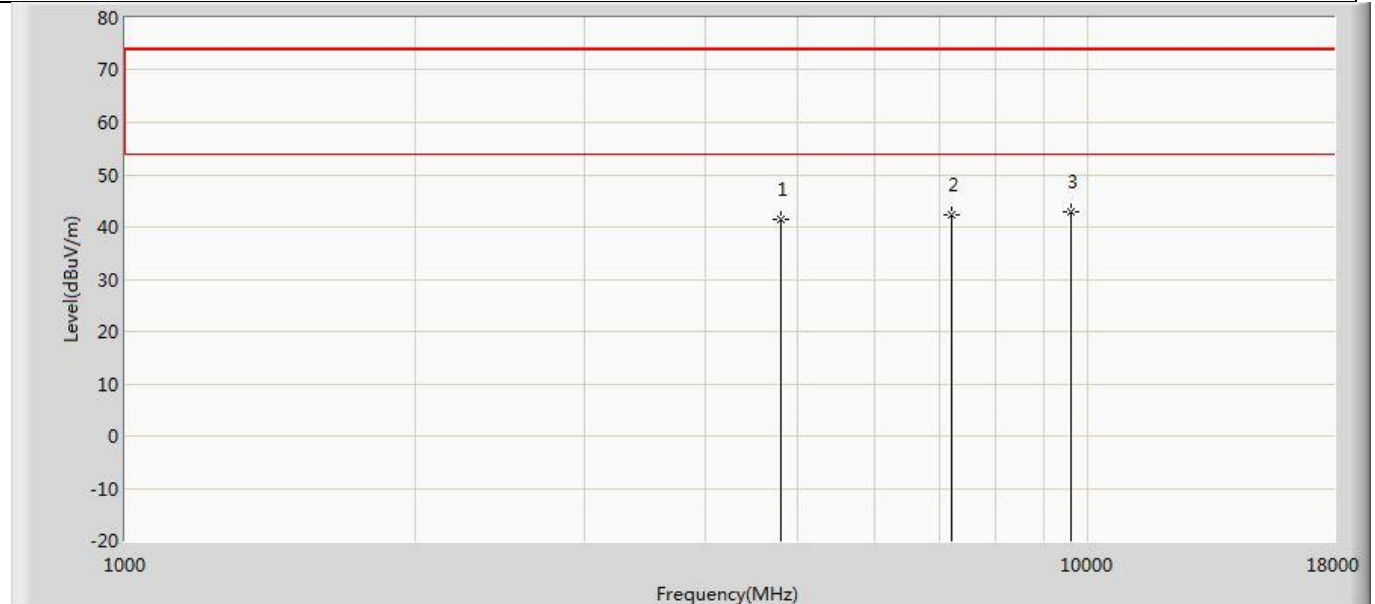

No	Mark	Frequency (MHz)	Measure Level (dBuV/m)	Reading Level (dBuV)	Over Limit (dB)	Limit (dBuV/m)	Factor (dB)	Type
1		4804.000	41.521	35.899	-32.479	74.000	5.621	PK
2		7206.000	42.284	33.216	-31.716	74.000	9.068	PK
3	*	9608.000	42.827	29.742	-31.173	74.000	13.084	PK

Profile: 21B0246R	Page No.: 45
Engineer: Neil	
Site: AC5	Time: 2021/11/11 - 21:00
Limit: FCC_Part15.209_RE(3m)	Margin: 0
Probe: Horn_3117_00123988_(1-18GHz)	Polarity: Horizontal
EUT: LED DEVICE	Power: AC 120V/60Hz
Note: Mode 3:Transmit at 2440MHz by 125k	

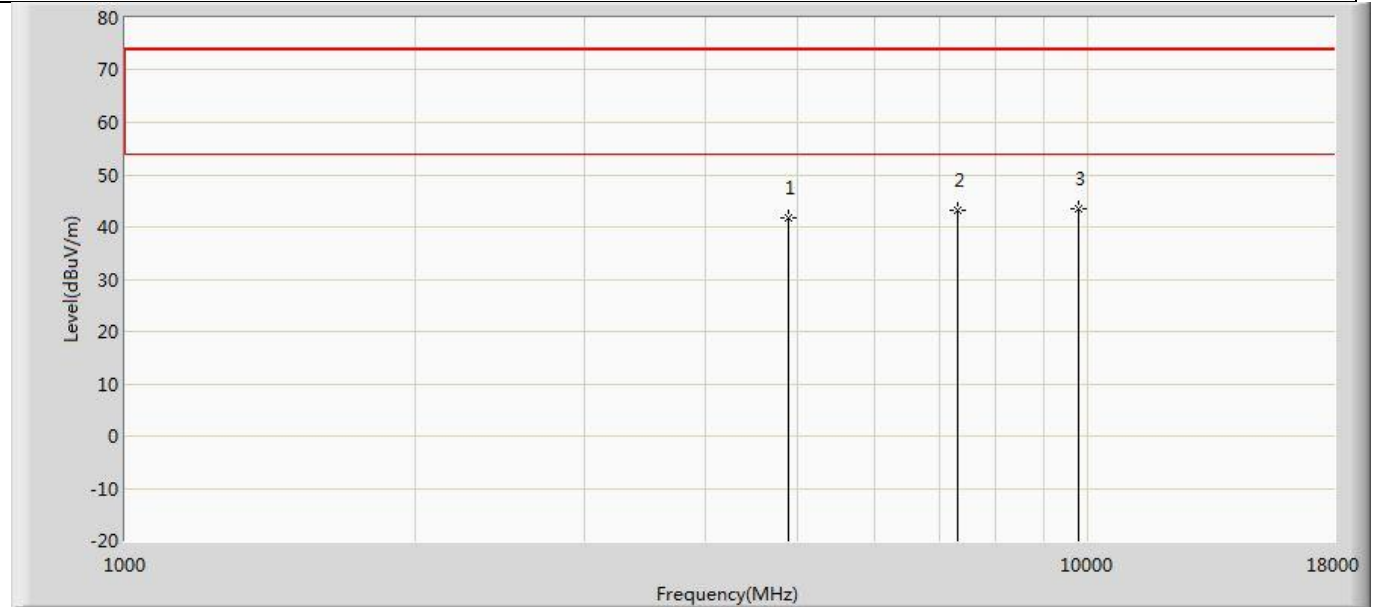

No	Mark	Frequency (MHz)	Measure Level (dBuV/m)	Reading Level (dBuV)	Over Limit (dB)	Limit (dBuV/m)	Factor (dB)	Type
1		4880.000	41.798	35.879	-32.202	74.000	5.919	PK
2		7320.000	43.272	33.766	-30.728	74.000	9.506	PK
3	*	9760.000	43.558	30.504	-30.442	74.000	13.054	PK

Profile: 21B0246R	Page No.: 46
Engineer: Neil	
Site: AC5	Time: 2021/11/11 - 21:01
Limit: FCC_Part15.209_RE(3m)	Margin: 0
Probe: Horn_3117_00123988_(1-18GHz)	Polarity: Vertical
EUT: LED DEVICE	Power: AC 120V/60Hz
Note: Mode 3:Transmit at 2440MHz by 125k	

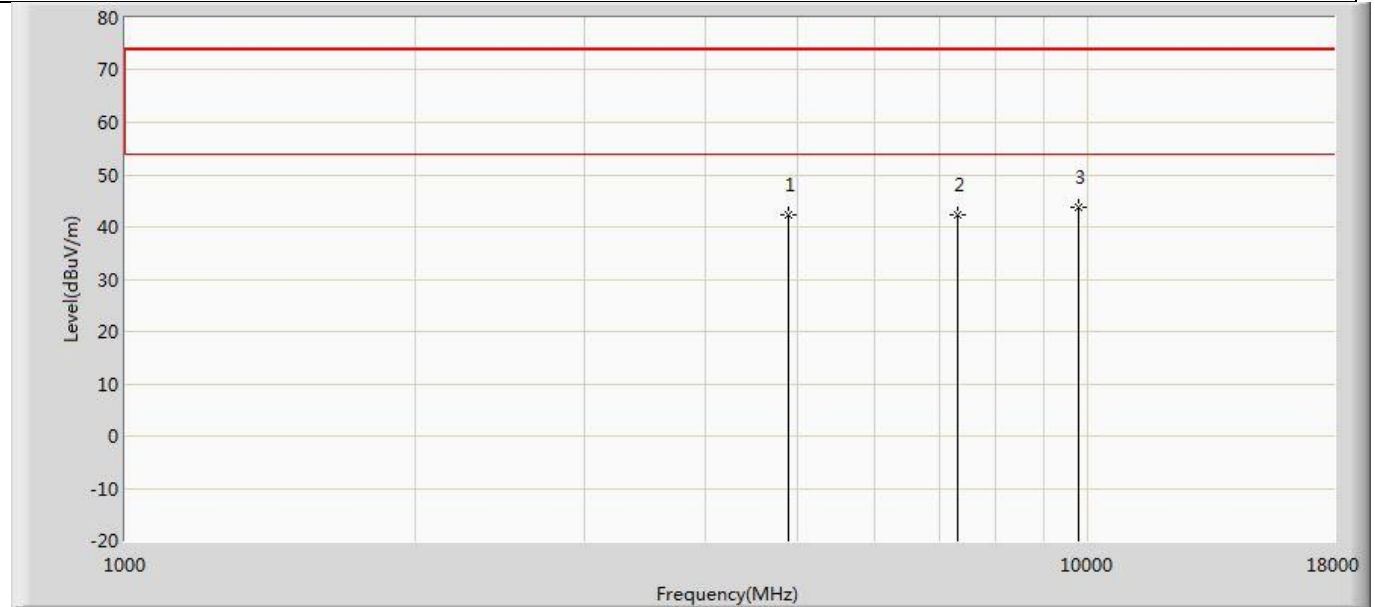

No	Mark	Frequency (MHz)	Measure Level (dBuV/m)	Reading Level (dBuV)	Over Limit (dB)	Limit (dBuV/m)	Factor (dB)	Type
1		4880.000	42.407	36.488	-31.593	74.000	5.919	PK
2		7320.000	42.284	32.778	-31.716	74.000	9.506	PK
3	*	9760.000	43.810	30.756	-30.190	74.000	13.054	PK

Profile: 21B0246R	Page No.: 47
Engineer: Neil	
Site: AC5	Time: 2021/11/11 - 21:01
Limit: FCC_Part15.209_RE(3m)	Margin: 0
Probe: Horn_3117_00123988_(1-18GHz)	Polarity: Horizontal
EUT: LED DEVICE	Power: AC 120V/60Hz
Note: Mode 3:Transmit at 2480MHz by 125k	

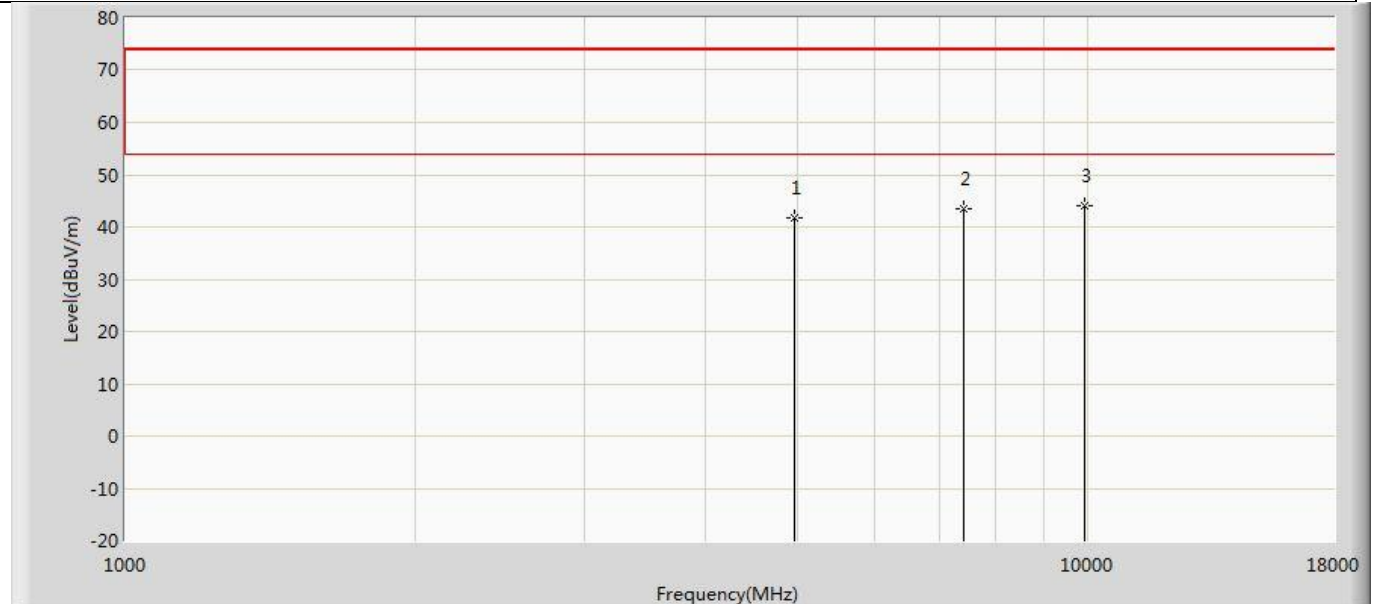

No	Mark	Frequency (MHz)	Measure Level (dBuV/m)	Reading Level (dBuV)	Over Limit (dB)	Limit (dBuV/m)	Factor (dB)	Type
1		4960.000	41.845	35.867	-32.155	74.000	5.978	PK
2		7440.000	43.448	33.921	-30.552	74.000	9.526	PK
3	*	9920.000	44.046	31.059	-29.954	74.000	12.986	PK

Profile: 21B0246R	Page No.: 48
Engineer: Neil	
Site: AC5	Time: 2021/11/11 - 21:01
Limit: FCC_Part15.209_RE(3m)	Margin: 0
Probe: Horn_3117_00123988_(1-18GHz)	Polarity: Vertical
EUT: LED DEVICE	Power: AC 120V/60Hz
Note: Mode 3:Transmit at 2480MHz by 125k	

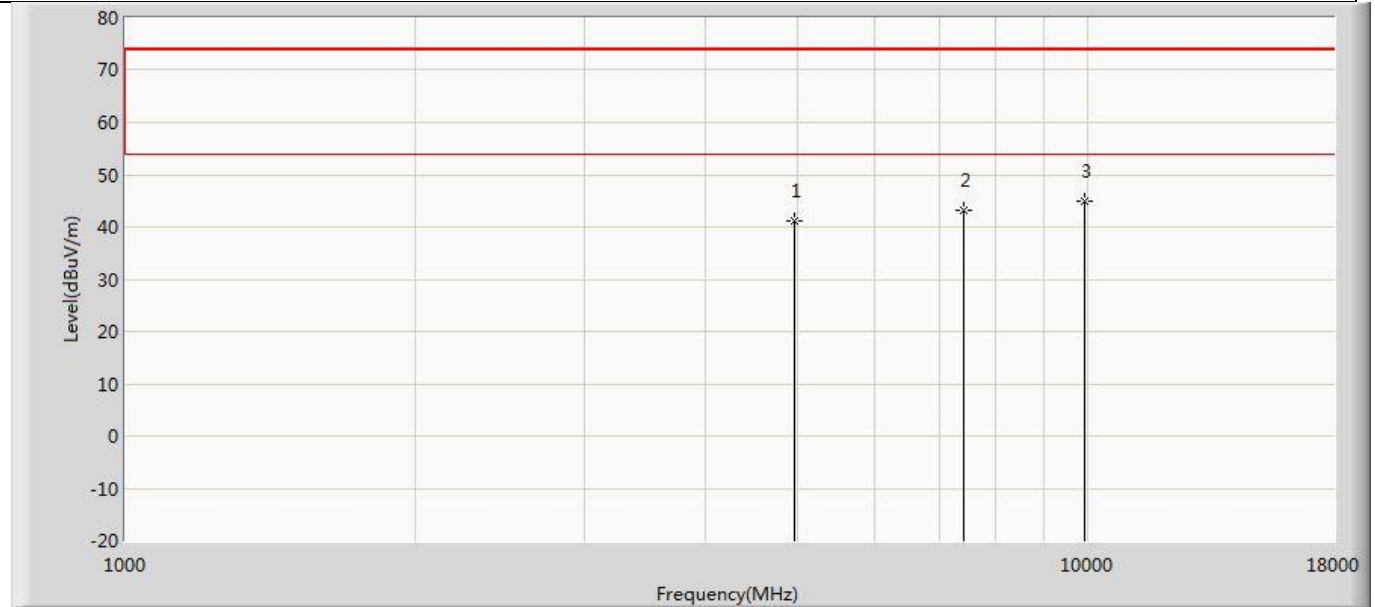

No	Mark	Frequency (MHz)	Measure Level (dBuV/m)	Reading Level (dBuV)	Over Limit (dB)	Limit (dBuV/m)	Factor (dB)	Type
1		4960.000	41.015	35.037	-32.985	74.000	5.978	PK
2		7440.000	43.313	33.786	-30.687	74.000	9.526	PK
3	*	9920.000	44.835	31.848	-29.165	74.000	12.986	PK

Profile: 21B0246R	Page No.: 49
Engineer: Neil	
Site: AC5	Time: 2021/11/11 - 21:01
Limit: FCC_Part15.209_RE(3m)	Margin: 0
Probe: Horn_3117_00123988_(1-18GHz)	Polarity: Horizontal
EUT: LED DEVICE	Power: AC 120V/60Hz
Note: Mode 4:Transmit at 2402MHz by 500k	

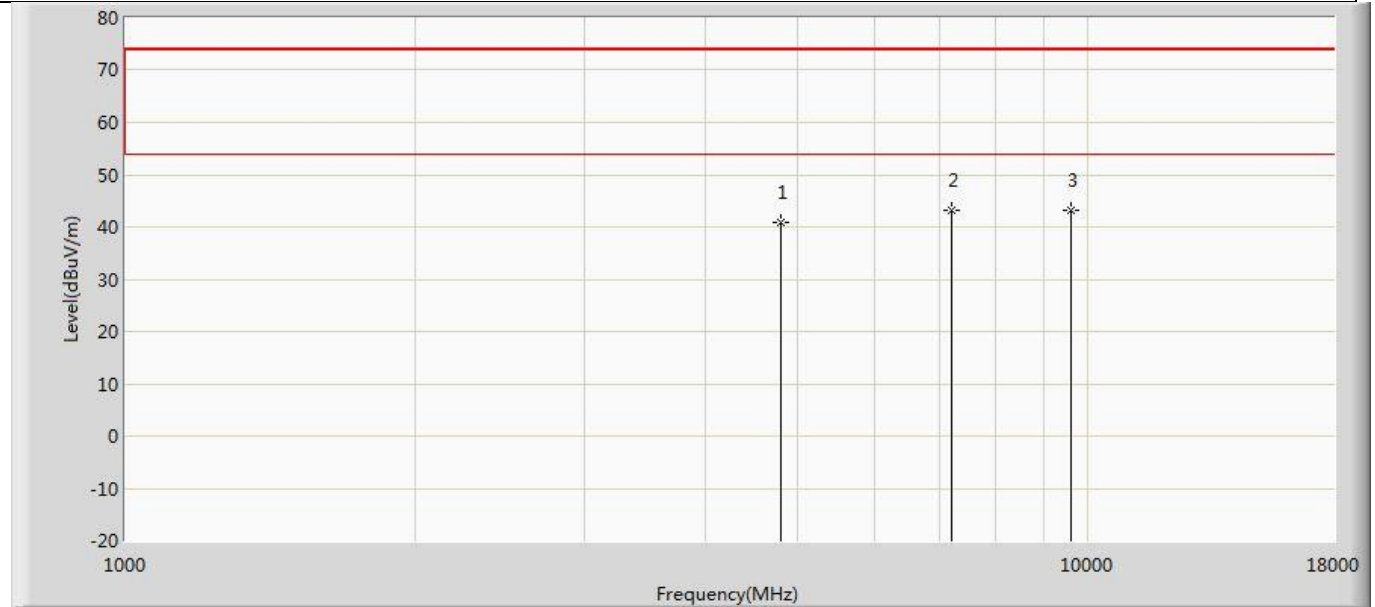

No	Mark	Frequency (MHz)	Measure Level (dBuV/m)	Reading Level (dBuV)	Over Limit (dB)	Limit (dBuV/m)	Factor (dB)	Type
1		4804.000	40.813	35.191	-33.187	74.000	5.621	PK
2		7206.000	43.164	34.096	-30.836	74.000	9.068	PK
3	*	9608.000	43.283	30.198	-30.717	74.000	13.084	PK

Profile: 21B0246R	Page No.: 50
Engineer: Neil	
Site: AC5	Time: 2021/11/11 - 21:01
Limit: FCC_Part15.209_RE(3m)	Margin: 0
Probe: Horn_3117_00123988_(1-18GHz)	Polarity: Vertical
EUT: LED DEVICE	Power: AC 120V/60Hz
Note: Mode 4:Transmit at 2402MHz by 500k	

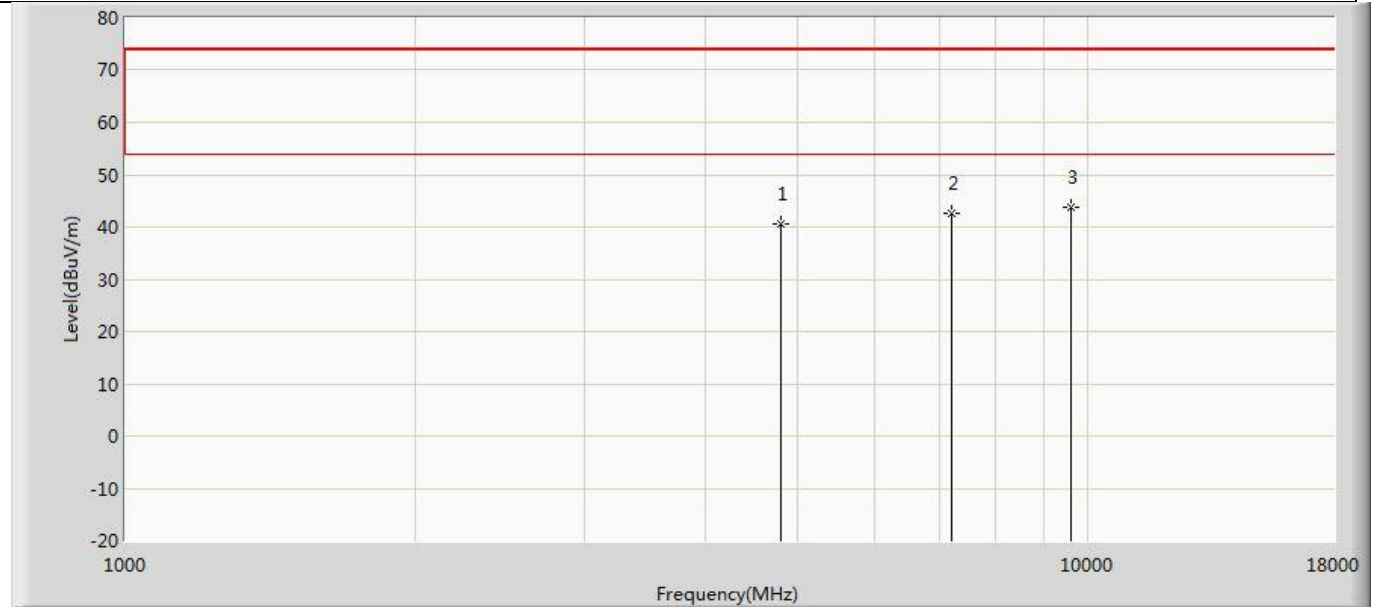

No	Mark	Frequency (MHz)	Measure Level (dBuV/m)	Reading Level (dBuV)	Over Limit (dB)	Limit (dBuV/m)	Factor (dB)	Type
1		4804.000	40.637	35.015	-33.363	74.000	5.621	PK
2		7206.000	42.705	33.637	-31.295	74.000	9.068	PK
3	*	9608.000	43.883	30.798	-30.117	74.000	13.084	PK

Profile: 21B0246R	Page No.: 51
Engineer: Neil	
Site: AC5	Time: 2021/11/11 - 21:01
Limit: FCC_Part15.209_RE(3m)	Margin: 0
Probe: Horn_3117_00123988_(1-18GHz)	Polarity: Horizontal
EUT: LED DEVICE	Power: AC 120V/60Hz
Note: Mode 4:Transmit at 2440MHz by 500k	

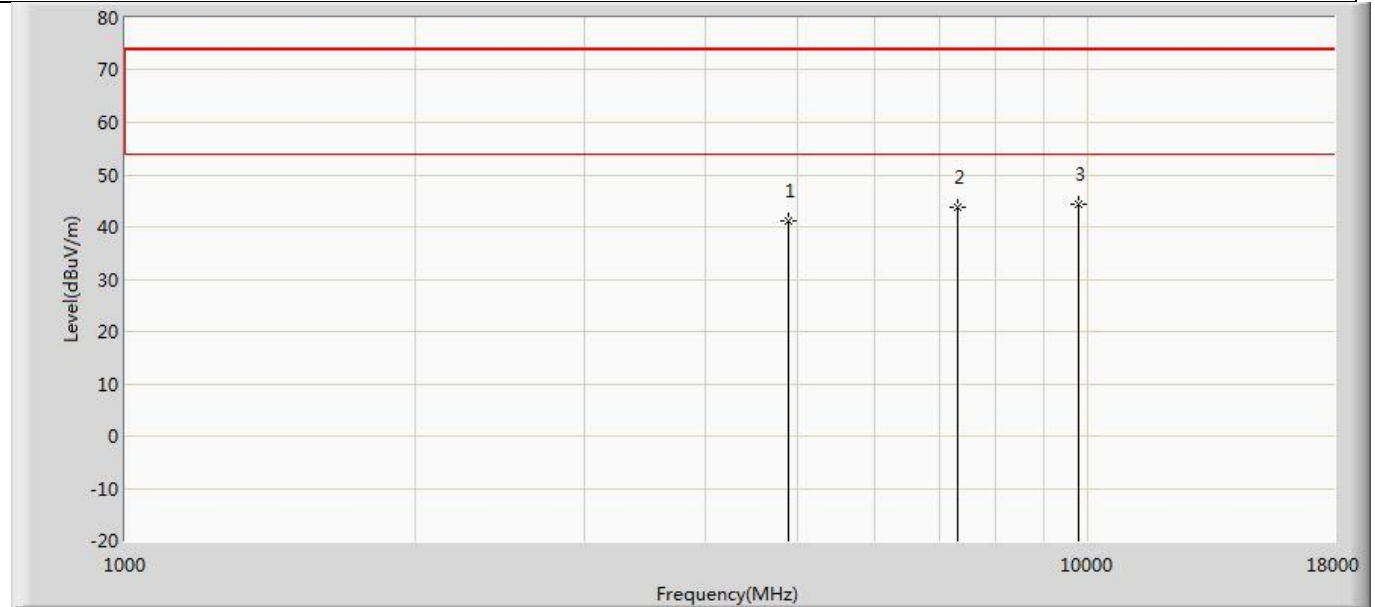

No	Mark	Frequency (MHz)	Measure Level (dBuV/m)	Reading Level (dBuV)	Over Limit (dB)	Limit (dBuV/m)	Factor (dB)	Type
1		4880.000	41.062	35.143	-32.938	74.000	5.919	PK
2		7320.000	43.643	34.137	-30.357	74.000	9.506	PK
3	*	9760.000	44.317	31.263	-29.683	74.000	13.054	PK

Profile: 21B0246R	Page No.: 52
Engineer: Neil	
Site: AC5	Time: 2021/11/11 - 21:01
Limit: FCC_Part15.209_RE(3m)	Margin: 0
Probe: Horn_3117_00123988_(1-18GHz)	Polarity: Vertical
EUT: LED DEVICE	Power: AC 120V/60Hz
Note: Mode 4:Transmit at 2440MHz by 500k	

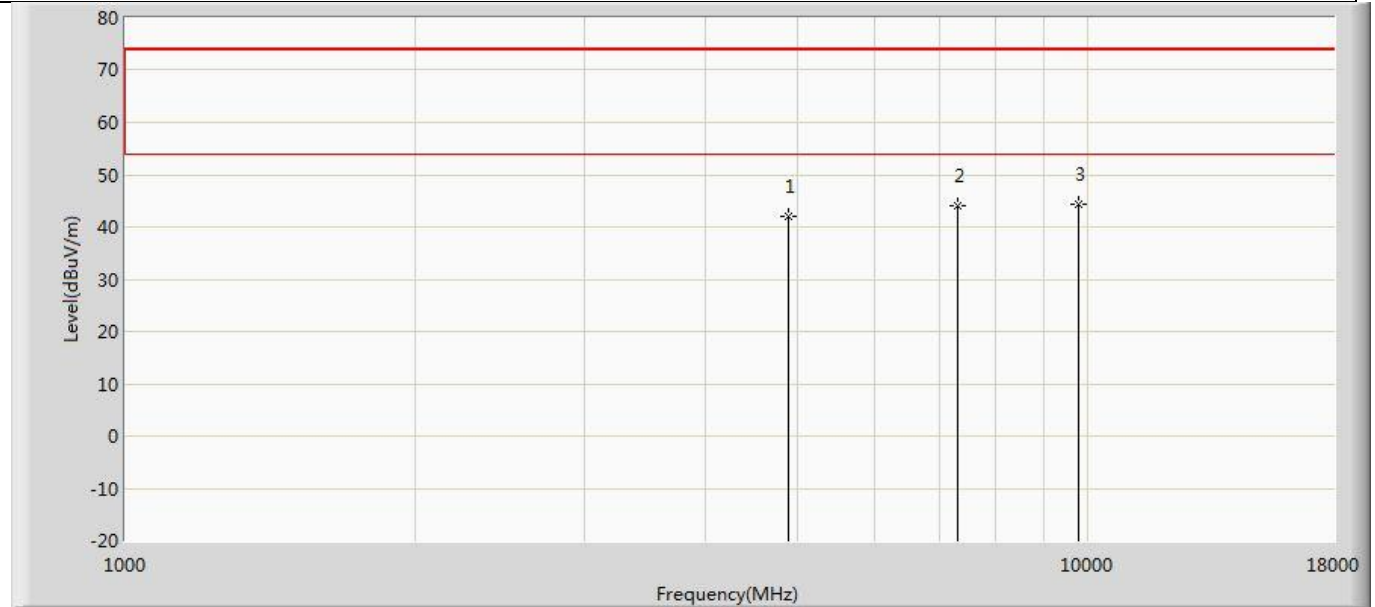

No	Mark	Frequency (MHz)	Measure Level (dBuV/m)	Reading Level (dBuV)	Over Limit (dB)	Limit (dBuV/m)	Factor (dB)	Type
1		4880.000	41.899	35.980	-32.101	74.000	5.919	PK
2		7320.000	43.990	34.484	-30.010	74.000	9.506	PK
3	*	9760.000	44.395	31.341	-29.605	74.000	13.054	PK

Profile: 21B0246R	Page No.: 53
Engineer: Neil	
Site: AC5	Time: 2021/11/11 - 21:01
Limit: FCC_Part15.209_RE(3m)	Margin: 0
Probe: Horn_3117_00123988_(1-18GHz)	Polarity: Horizontal
EUT: LED DEVICE	Power: AC 120V/60Hz
Note: Mode 4:Transmit at 2480MHz by 500k	

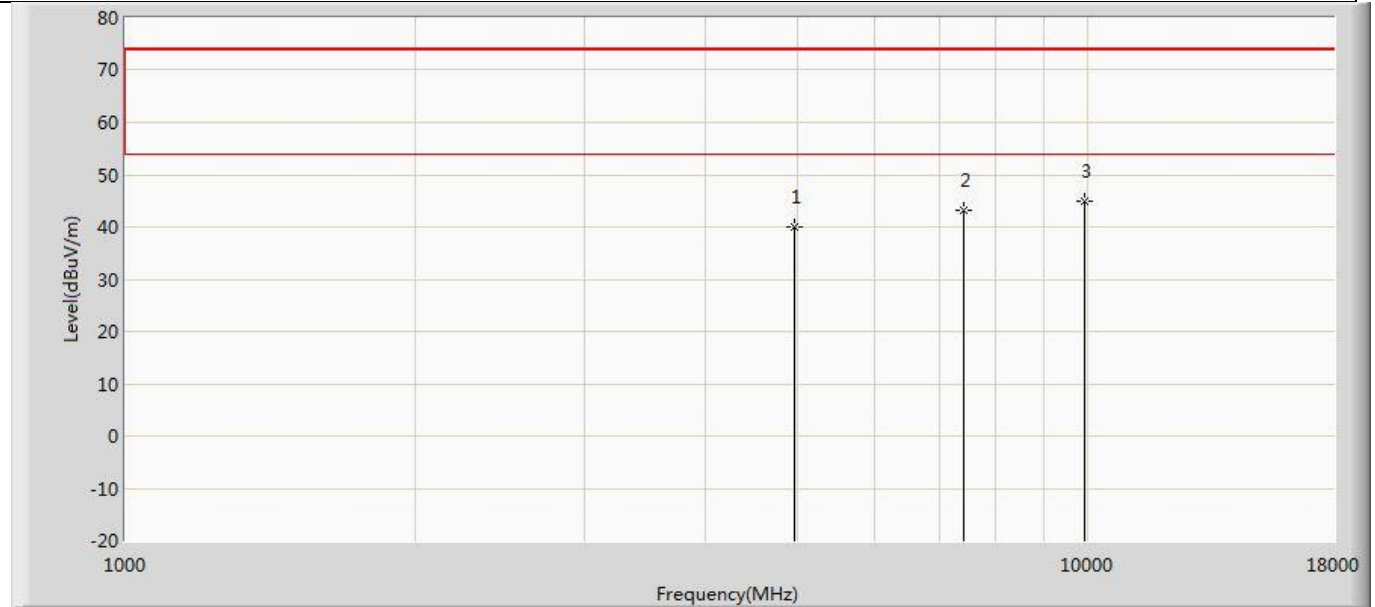

No	Mark	Frequency (MHz)	Measure Level (dBuV/m)	Reading Level (dBuV)	Over Limit (dB)	Limit (dBuV/m)	Factor (dB)	Type
1		4960.000	39.915	33.937	-34.085	74.000	5.978	PK
2		7440.000	43.086	33.559	-30.914	74.000	9.526	PK
3	*	9920.000	45.030	32.043	-28.970	74.000	12.986	PK

Profile: 21B0246R	Page No.: 54
Engineer: Neil	
Site: AC5	Time: 2021/11/11 - 21:01
Limit: FCC_Part15.209_RE(3m)	Margin: 0
Probe: Horn_3117_00123988_(1-18GHz)	Polarity: Vertical
EUT: LED DEVICE	Power: AC 120V/60Hz
Note: Mode 4:Transmit at 2480MHz by 500k	

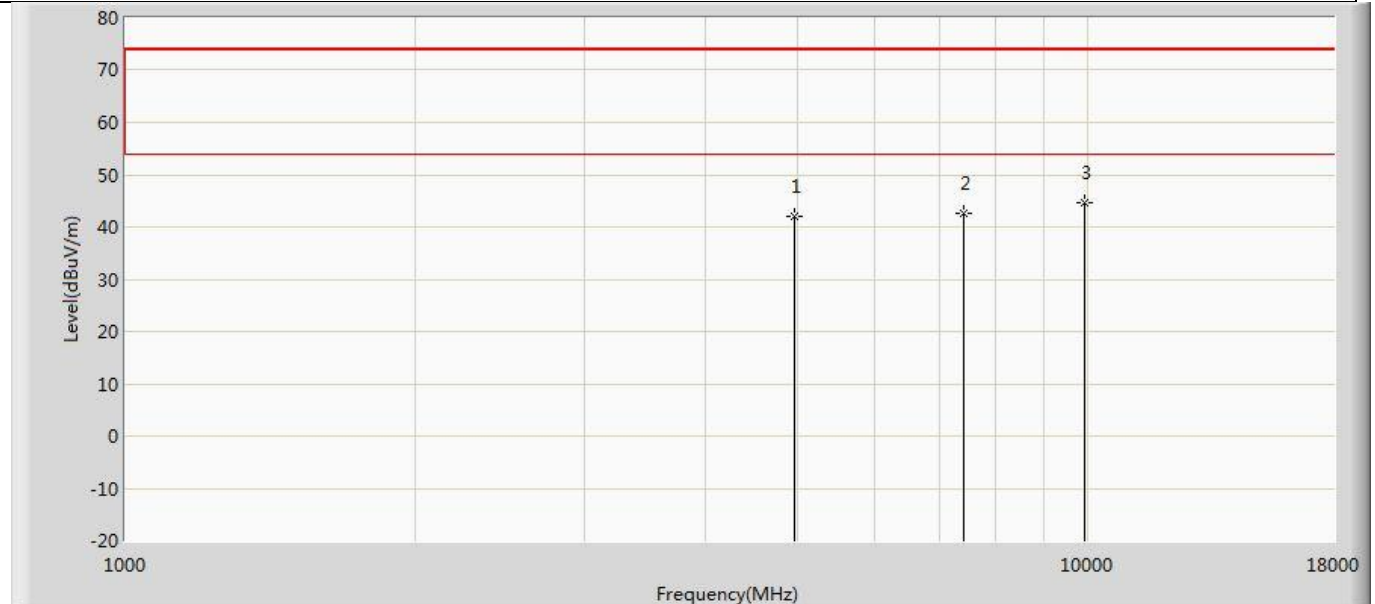

No	Mark	Frequency (MHz)	Measure Level (dBuV/m)	Reading Level (dBuV)	Over Limit (dB)	Limit (dBuV/m)	Factor (dB)	Type
1		4960.000	42.080	36.102	-31.920	74.000	5.978	PK
2		7440.000	42.749	33.222	-31.251	74.000	9.526	PK
3	*	9920.000	44.591	31.604	-29.409	74.000	12.986	PK

Note:

1. Measured Level = Reading Level + Factor.
2. The test frequency range, 9kHz~30MHz, 18GHz~26GHz, both of the worst case are at least 20dB below the limits, therefore no data appear in the report.
3. This limit applies for using average detector, if the test result on peak is lower than average limit, then average measurement needn't be performed.
4. As the radiated emission was performed, so conducted emission was not tested.

The worst case of Radiated Emission below 1GHz:

Profile: 21B0246R	Page No.: 1
Engineer: Neil	
Site: AC2	Time: 2021/11/26 - 02:57
Limit: FCC_Part15.109_RE(3m)_ClassB	Margin: 4
Probe: AC2_3M(30-1000M)	Polarity: Horizontal
EUT: LED DEVICE	Power: AC 120V/60Hz
Note: Modle1	

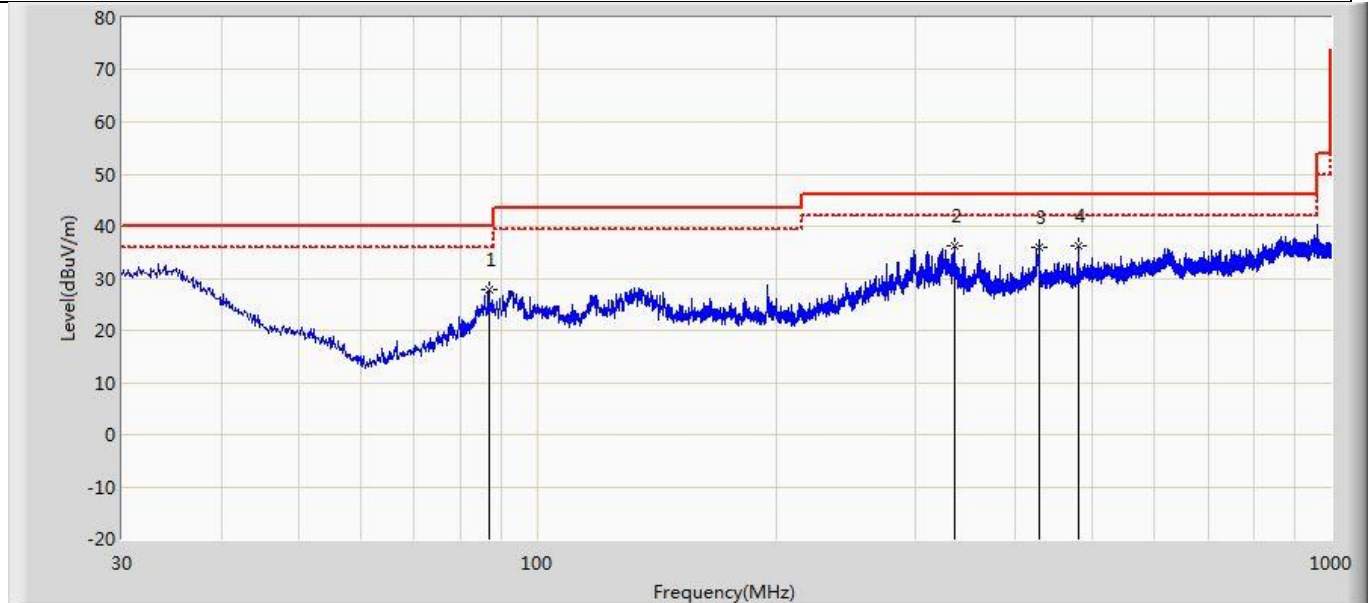

No	Mark	Frequency (MHz)	Measure Level (dBuV/m)	Reading Level (dBuV)	Over Limit (dB)	Limit (dBuV/m)	Factor (dB)	Type
1		86.866	27.719	13.618	-12.281	40.000	14.101	PK
2		335.307	36.103	13.297	-9.897	46.000	22.806	PK
3		428.791	35.874	9.297	-10.126	46.000	26.577	PK
4	*	479.959	36.272	9.252	-9.728	46.000	27.019	PK

Note:

1. All Readings below 1GHz are Quasi-Peak, above are performed with peak and/or average measurements as necessary.
2. " * ", means this data is the worst emission level.
3. Measurement Level = Reading Level + Factor(Probe+Cable-Amp).

Profile: 21B0246R	Page No.: 2
Engineer: Neil	
Site: AC2	Time: 2021/11/26 - 02:59
Limit: FCC_Part15.109_RE(3m)_ClassB	Margin: 4
Probe: AC2_3M(30-1000M)	Polarity: Vertical
EUT: LED DEVICE	Power: AC 120V/60Hz
Note: Modle1	

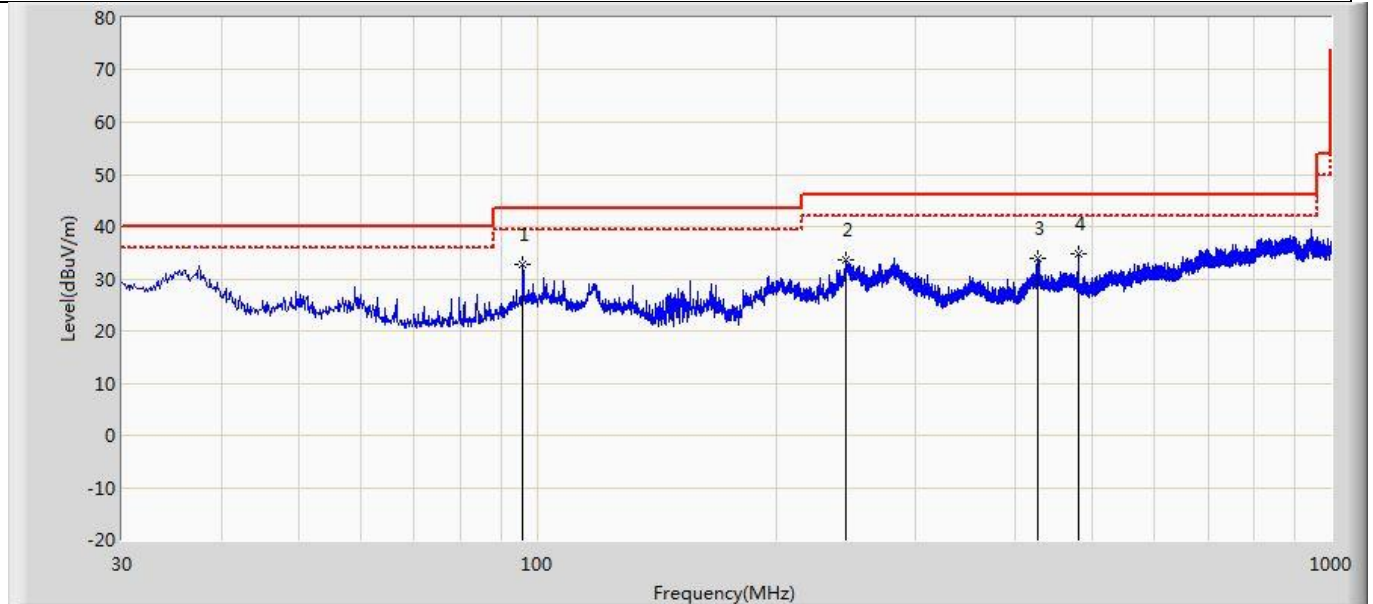

No	Mark	Frequency (MHz)	Measure Level (dBuV/m)	Reading Level (dBuV)	Over Limit (dB)	Limit (dBuV/m)	Factor (dB)	Type
1	*	95.960	32.740	12.574	-10.760	43.500	20.166	PK
2		245.098	33.711	9.980	-12.289	46.000	23.731	PK
3		428.064	33.976	8.117	-12.024	46.000	25.859	PK
4		479.959	34.713	9.128	-11.287	46.000	25.585	PK

Note:

1. All Readings below 1GHz are Quasi-Peak, above are performed with peak and/or average measurements as necessary.
2. " * ", means this data is the worst emission level.
3. Measurement Level = Reading Level + Factor(Probe+Cable-Amp).

4.3 Emissions in non-restricted frequency band	VERDICT: PASS
---	----------------------

4.3.1 Limit

Standard	FCC Part 15 Subpart C Paragraph 15.247(d)		
RF Output power (Detection methods)			Limit(dB)
RF Output power(Average detector)			30dBc(Note1)
RF Output power(PK detector)			20dBc(Note2)

Note 1: If maximum conducted (average) output power was used to demonstrate compliance as described in 9.2, then the peak power in any 100 kHz bandwidth outside of the authorized frequency band shall be attenuated by at least 30 dB relative to the maximum in-band peak PSD level in 100 kHz (i.e., 30 dBc).

Note 2: If the maximum peak conducted output power procedure was used, then the peak output power measured in any 100 kHz bandwidth outside of the authorized frequency band shall be attenuated by at least 20 dB relative to the maximum in-band peak PSD level in 100 kHz (i.e., 20 dBc).

4.3.2 Test Setup

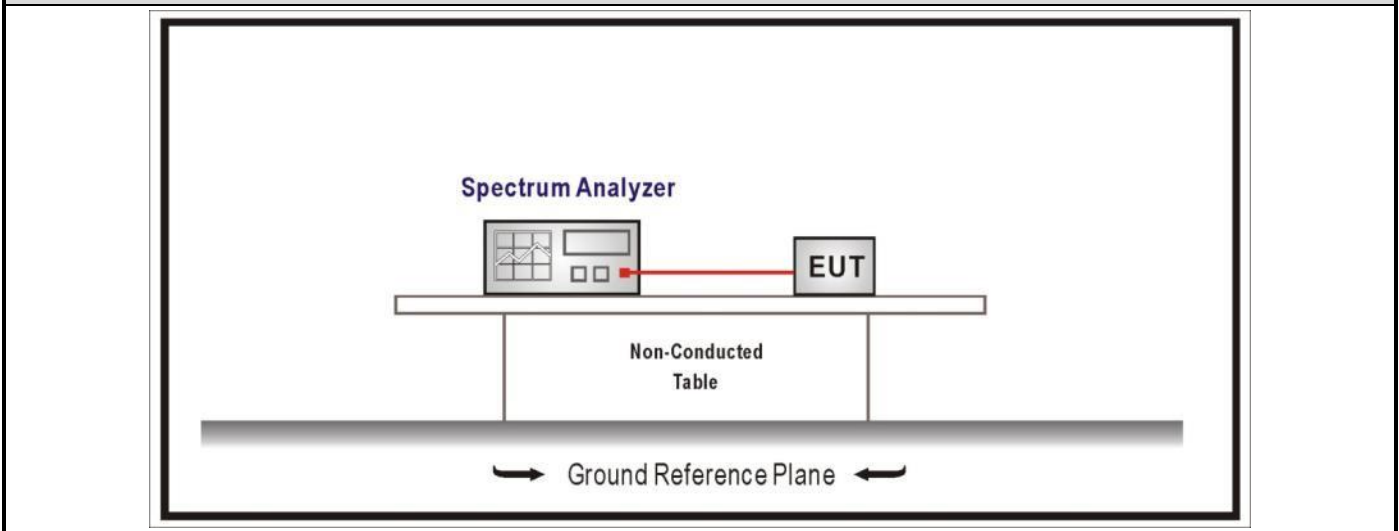

4.3.3 Test Procedure

References Rule	Chapter	Description
<input checked="" type="checkbox"/> ANSI C63.10	11.11	Emissions in non-restricted frequency bands
<input checked="" type="checkbox"/> ANSI C63.10	11.11.1	General
<input checked="" type="checkbox"/> ANSI C63.10	11.11.2	Reference level measurement
<input checked="" type="checkbox"/> ANSI C63.10	11.11.3	Emission level measurement

4.3.4 Test Data

Mode	Channel	Test Frequency (MHz)	Maximum In-Band PSD[a] (dBm/100kHz)	Frequency (MHz)	Out-Band PSD[b] (dBm/100kHz)	[a]-[b] (dB)	Limit (dB)	Result
1	00	2402	8.646	2400	-42.802	51.448	>20	Pass
	39	2480	8.480	2500	-51.709	60.189	>20	Pass
2	00	2402	6.601	2400	-23.876	30.477	>20	Pass
	39	2480	6.569	2500	-52.116	58.685	>20	Pass
3	00	2402	5.888	2400	-42.087	47.975	>20	Pass
	39	2480	5.762	2500	-53.170	58.932	>20	Pass
4	00	2402	8.550	2400	-43.702	52.252	>20	Pass
	39	2480	8.256	2500	-51.697	59.953	>20	Pass

Note 1: The worst data plot as below:

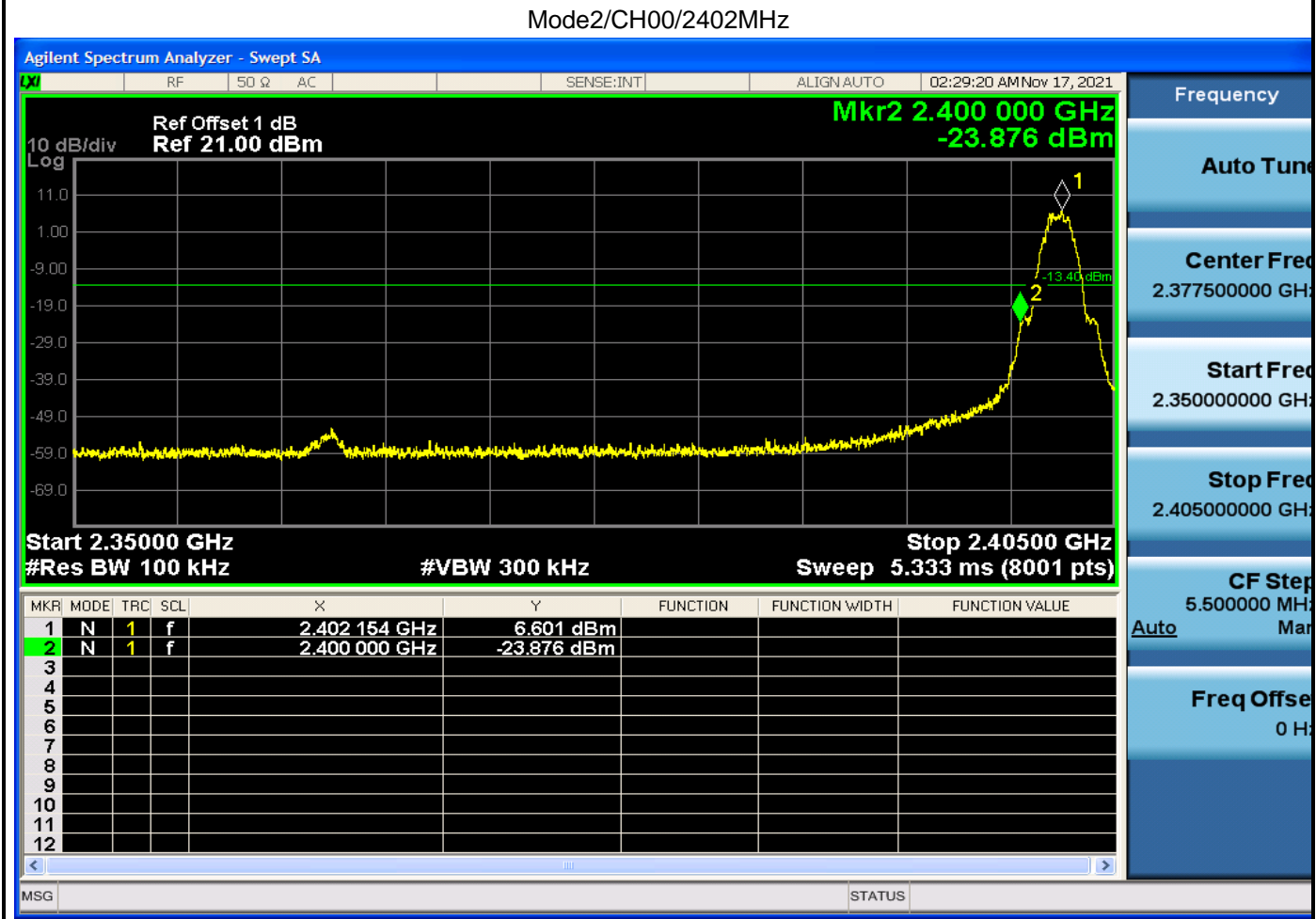

The data of entire corresponding spectrum:

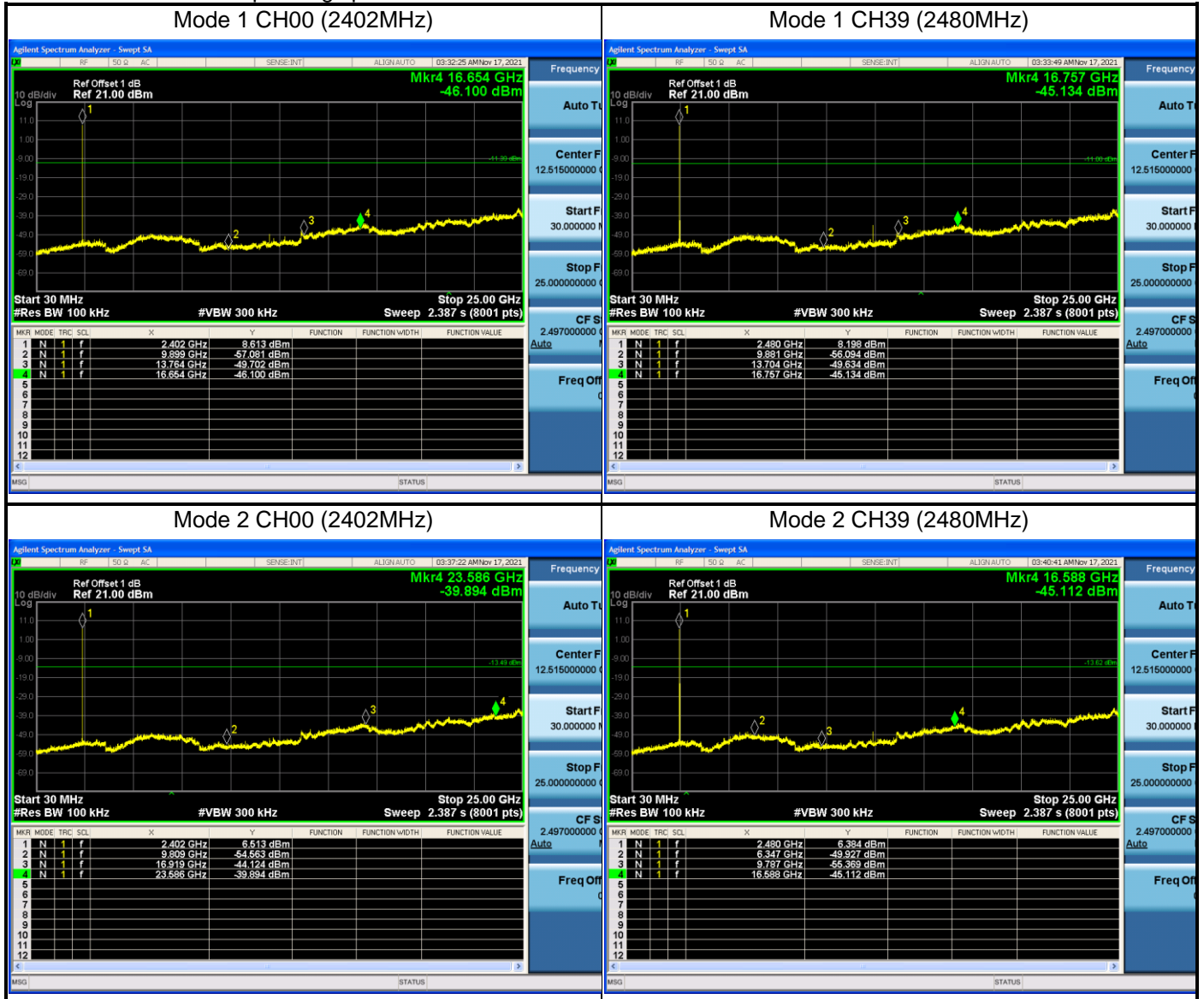

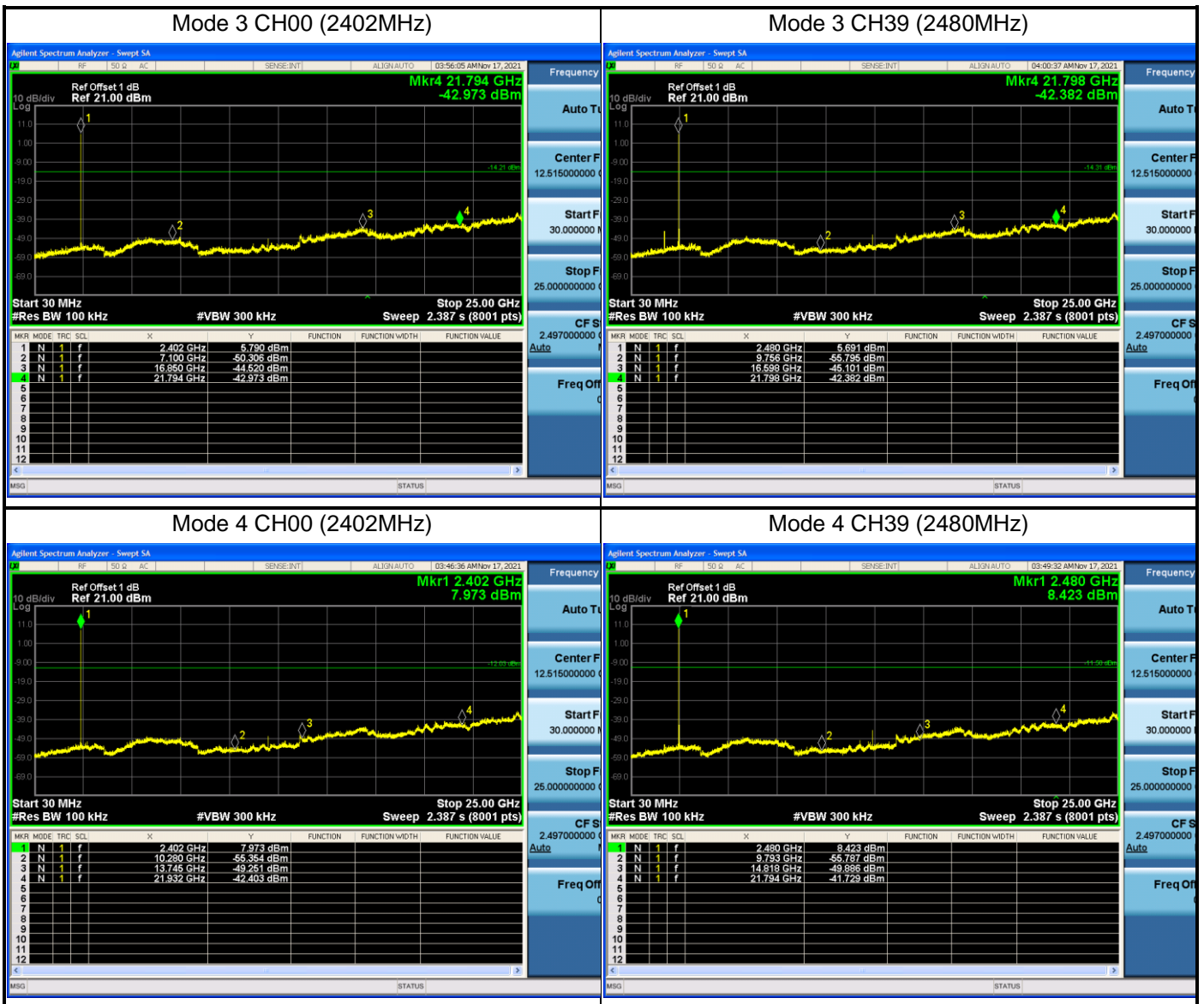

4.4 Duty cycle	VERDICT: PASS
-----------------------	----------------------

4.4.1 Limit

N/A

4.4.2 Test Setup

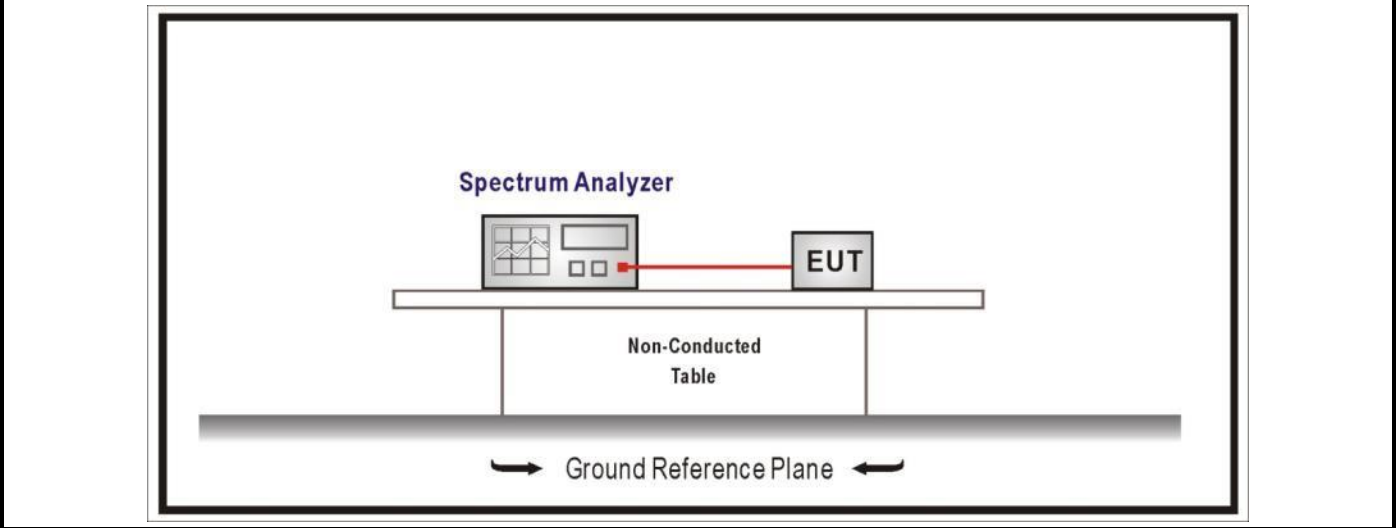

4.4.3 Test Procedure

References Rule	Chapter	Description
<input checked="" type="checkbox"/> ANSI C63.10	11.6	Duty cycle (D), transmission duration (T), and maximum power control level

4.4.4 Test Data

Test Mode	Tx On (us)	Tx Off (us)	VBW (kHz)	Tx On + Tx Off (us)	Duty Cycle (%)
Mode 1	--	--	--	--	100
Mode 2	--	--	--	--	100
Mode 3	--	--	--	--	100
Mode 4	--	--	--	--	100

Note 1: T means the minimum transmission duration over which the transmitter is on and is transmitting at its maximum power control level for the tested mode of operation.

Note 2: According to KDB 558074, when test for Radiated Emission Band Edge and Radiated Emission, for average detector set: $VBW \geq 1/T$ will be used.

Mode 1 CH19 2440MHz

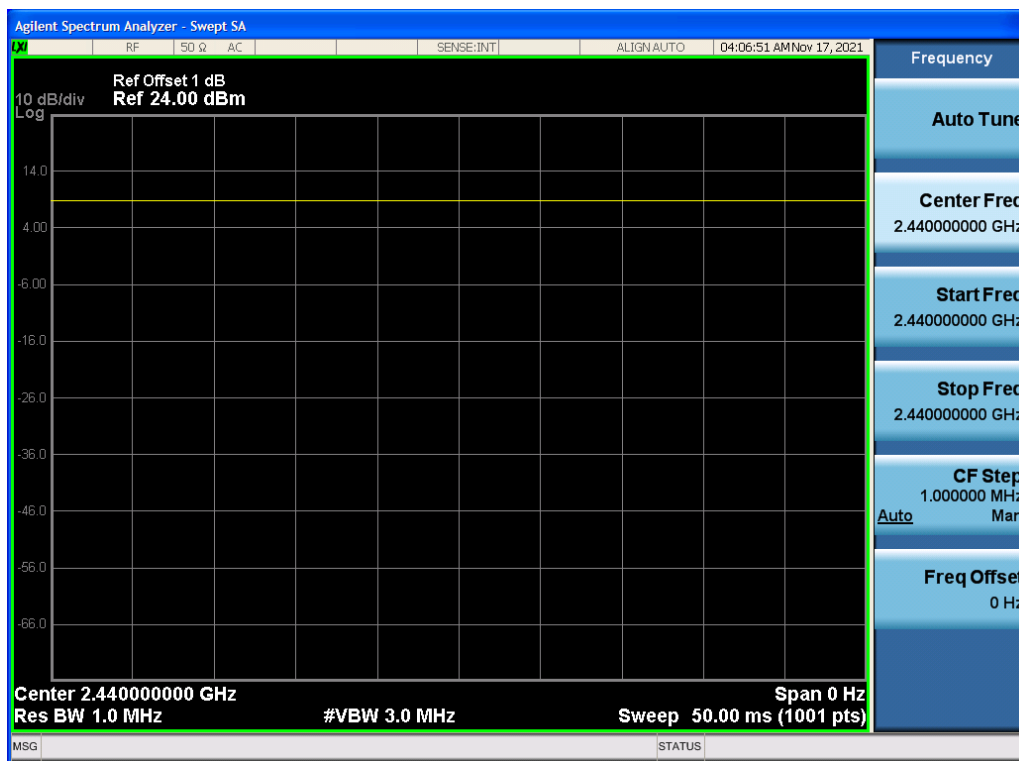

4.5 Radiated Emission Band Edge	VERDICT: PASS
--	----------------------

4.5.1 Limit

Standard		FCC Part 15 Subpart C Paragraph 15.247(d) , 15.209		
Frequency bands (MHz)	Detector	Limit (dBµV/m)	RBW (MHz)	Distance (m)
2310-2390	PK	74	1	3
2483.5-2500	AV	54	1	3

Note: The field strength of emissions appearing within these frequency bands shall not exceed the limits.

4.5.2 Test Setup

Above 1GHz Test Setup:

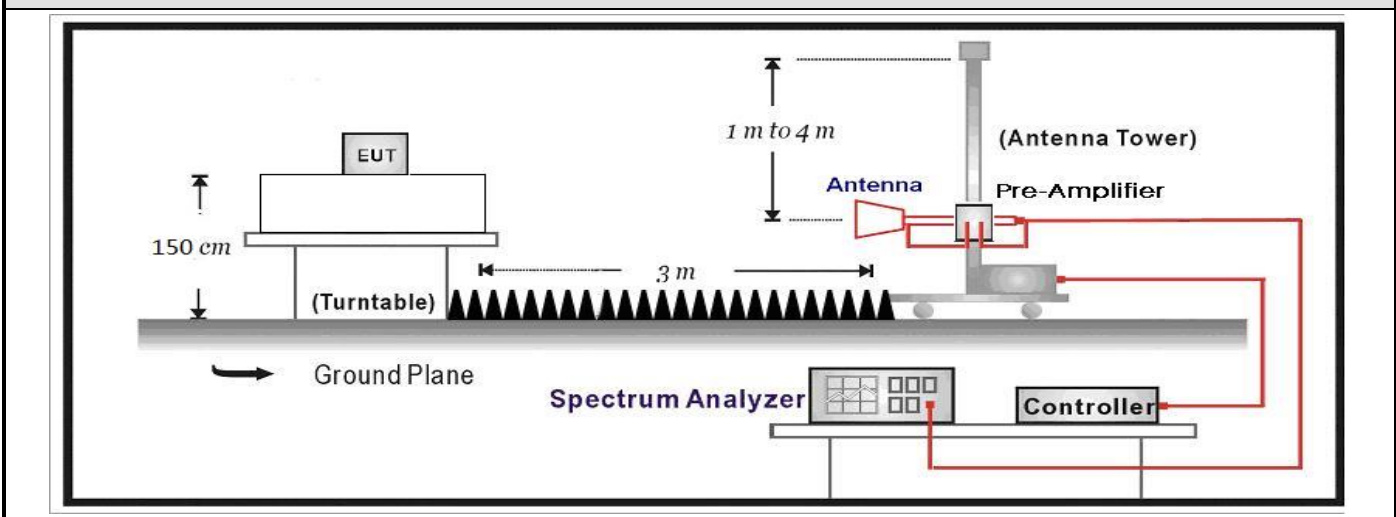

4.5.3 Test Procedure

	References Rule	Chapter	Description
<input checked="" type="checkbox"/>	ANSI C63.10	6.10	Band-edge testing
	<input checked="" type="checkbox"/> ANSI C63.10	6.10.5	Restricted-band band-edge measurements
	<input type="checkbox"/> ANSI C63.10	6.10.6	Marker-delta method
<input checked="" type="checkbox"/>	ANSI C63.10	11.12	Emissions in restricted frequency bands
	<input checked="" type="checkbox"/> ANSI C63.10	11.12.1	Radiated emission measurements
	<input checked="" type="checkbox"/> ANSI C63.10	11.12.2.7	Radiated spurious emission test
<input type="checkbox"/>	ANSI C63.10	6.4	Radiated emissions from unlicensed wireless devices below 30 MHz
<input type="checkbox"/>	ANSI C63.10	6.5	Radiated emissions from unlicensed wireless devices in the frequency range of 30 MHz to 1000 MHz
<input checked="" type="checkbox"/>	ANSI C63.10	6.6	Radiated emissions from unlicensed wireless devices above 1 GHz

4.5.4 Test Data

Profile: 21B0246R	Page No.: 1
Engineer: Juliuszhou	
Site: AC5	Time: 2020/03/12 - 00:39
Limit: FCC_Part15.209_RE(3m)	Margin: 0
Probe: Horn_3117_00123988_(1-18GHz)	Polarity: Vertical
EUT: LED Device	Power: AC 120V/60Hz
Note: Mode 1:Transmit at 2402MHz by LE_1Mbps	

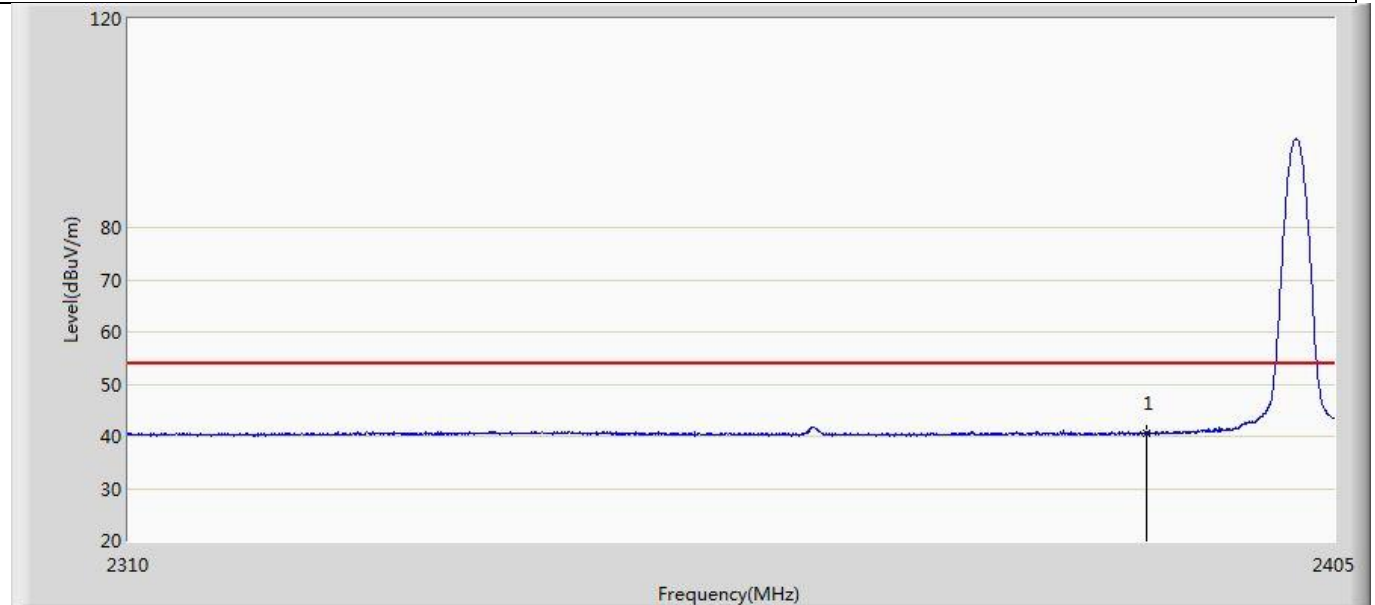

No	Mark	Frequency (MHz)	Measure Level (dBuV/m)	Reading Level (dBuV)	Over Limit (dB)	Limit (dBuV/m)	Factor (dB)	Type
1	*	2390.000	40.446	4.987	-13.554	54.000	35.459	AV

Profile: 21B0246R	Page No.: 2
Engineer: Juliuszhou	
Site: AC5	Time: 2021/05/25 - 20:16
Limit: FCC_Part15.209_RE(3m)	Margin: 0
Probe: Horn_3117_00123988_(1-18GHz)	Polarity: Vertical
EUT: LED Device	Power: AC 120V/60Hz
Note: Mode 1:Transmit at 2402MHz by LE_1Mbps	

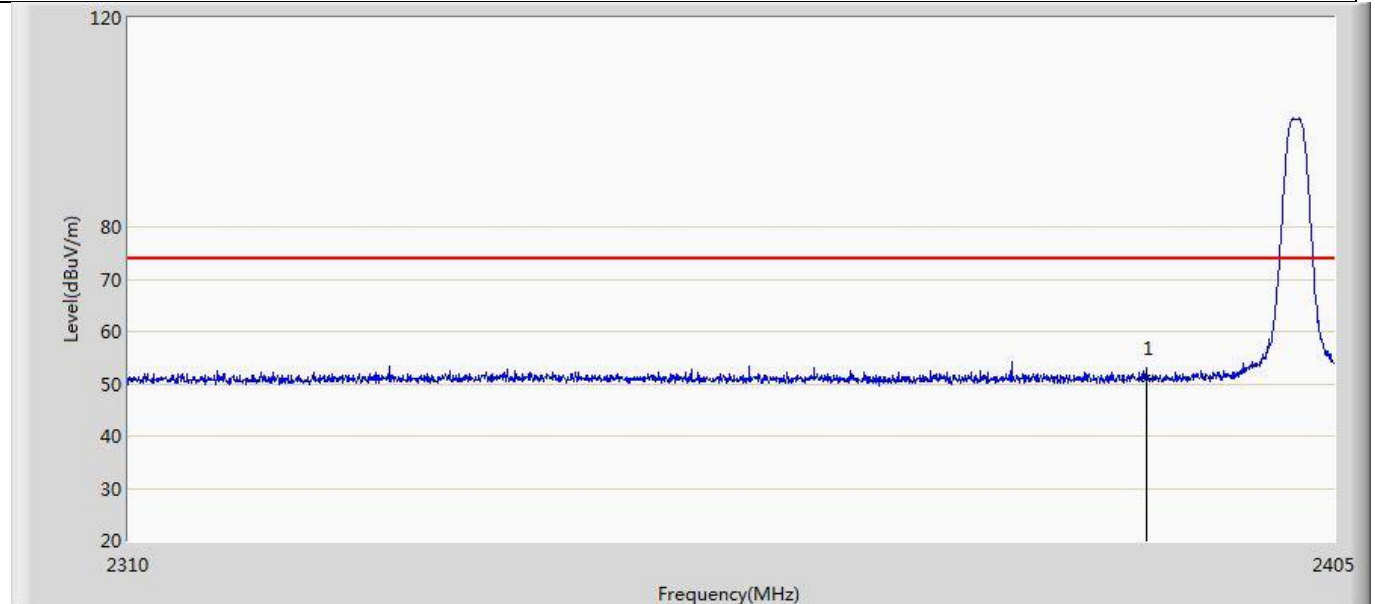

No	Mark	Frequency (MHz)	Measure Level (dBuV/m)	Reading Level (dBuV)	Over Limit (dB)	Limit (dBuV/m)	Factor (dB)	Type
1	*	2390.000	50.965	15.506	-23.035	74.000	35.459	PK

Profile: 21B0246R	Page No.: 3
Engineer: Juliuszhou	
Site: AC5	Time: 2021/05/25 - 20:20
Limit: FCC_Part15.209_RE(3m)	Margin: 0
Probe: Horn_3117_00123988_(1-18GHz)	Polarity: Horizontal
EUT: LED Device	Power: AC 120V/60Hz
Note: Mode 1:Transmit at 2402MHz by LE_1Mbps	

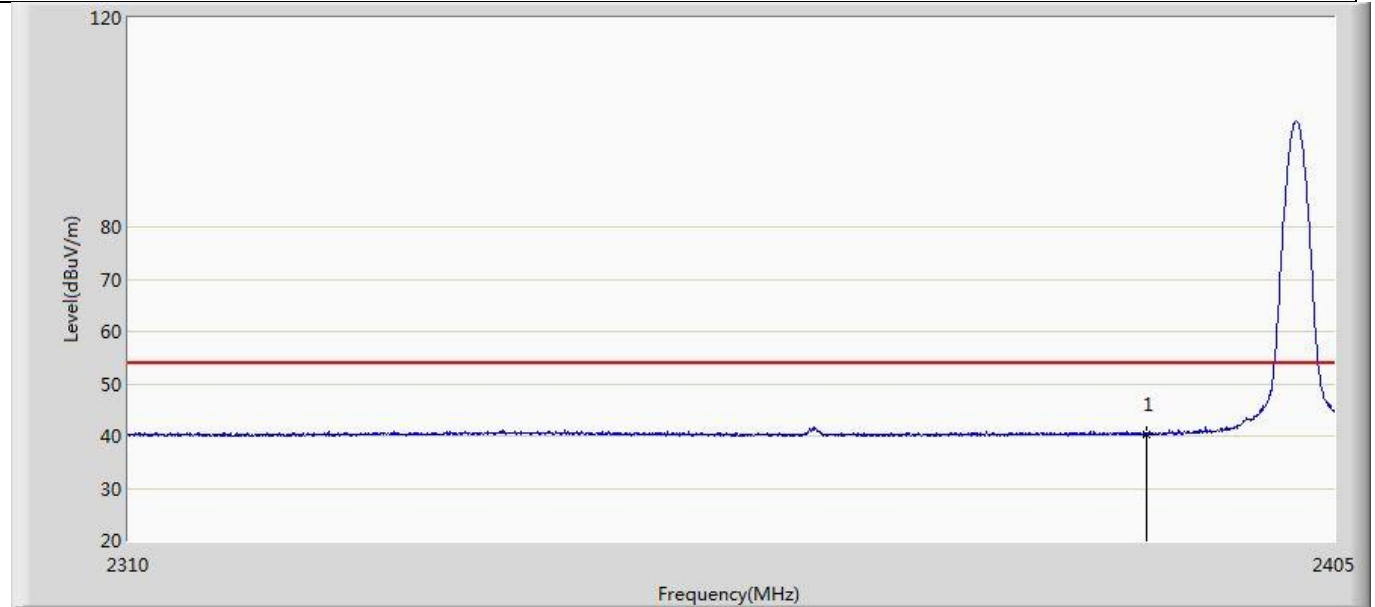

No	Mark	Frequency (MHz)	Measure Level (dBuV/m)	Reading Level (dBuV)	Over Limit (dB)	Limit (dBuV/m)	Factor (dB)	Type
1	*	2390.000	40.337	4.878	-13.663	54.000	35.459	AV

Profile: 21B0246R	Page No.: 4
Engineer: Juliuszhou	
Site: AC5	Time: 2021/05/25 - 20:21
Limit: FCC_Part15.209_RE(3m)	Margin: 0
Probe: Horn_3117_00123988_(1-18GHz)	Polarity: Horizontal
EUT: LED Device	Power: AC 120V/60Hz
Note: Mode 1:Transmit at 2402MHz by LE_1Mbps	

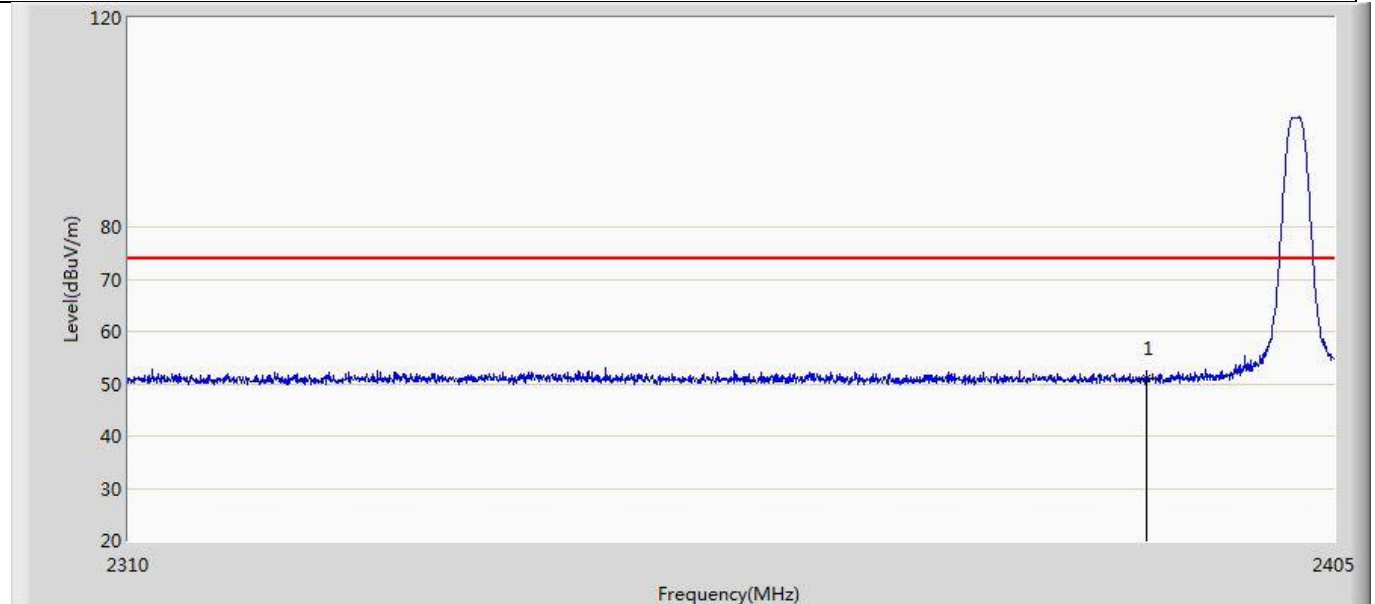

No	Mark	Frequency (MHz)	Measure Level (dBuV/m)	Reading Level (dBuV)	Over Limit (dB)	Limit (dBuV/m)	Factor (dB)	Type
1	*	2390.000	50.968	15.509	-23.032	74.000	35.459	PK

Profile: 21B0246R	Page No.: 17
Engineer: Juliuszhou	
Site: AC5	Time: 2021/05/25 - 20:39
Limit: FCC_Part15.209_RE(3m)	Margin: 0
Probe: Horn_3117_00123988_(1-18GHz)	Polarity: Vertical
EUT: LED Device	Power: AC 120V/60Hz
Note: Mode 1:Transmit at 2480MHz by LE_1Mbps	

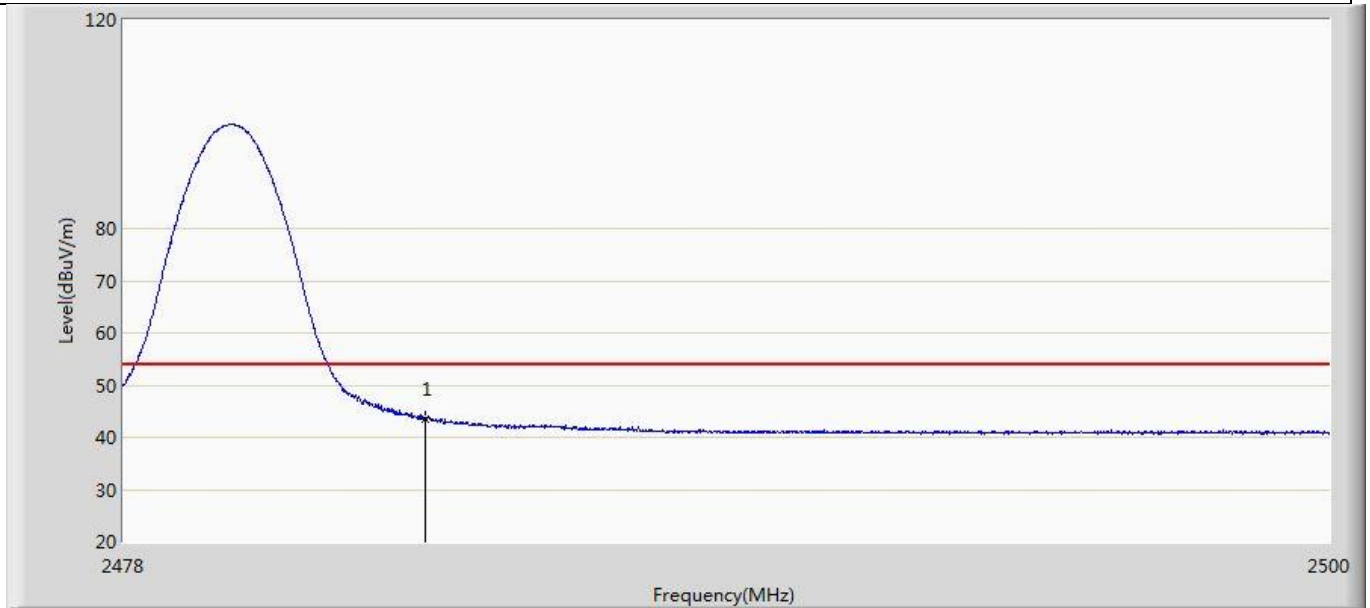

No	Mark	Frequency (MHz)	Measure Level (dBuV/m)	Reading Level (dBuV)	Over Limit (dB)	Limit (dBuV/m)	Factor (dB)	Type
1	*	2483.500	43.600	7.925	-10.400	54.000	35.675	AV

Profile: 21B0246R	Page No.: 18
Engineer: Juliuszhou	
Site: AC5	Time: 2021/05/25 - 20:41
Limit: FCC_Part15.209_RE(3m)	Margin: 0
Probe: Horn_3117_00123988_(1-18GHz)	Polarity: Vertical
EUT: LED Device	Power: AC 120V/60Hz
Note: Mode 1:Transmit at 2480MHz by LE_1Mbps	

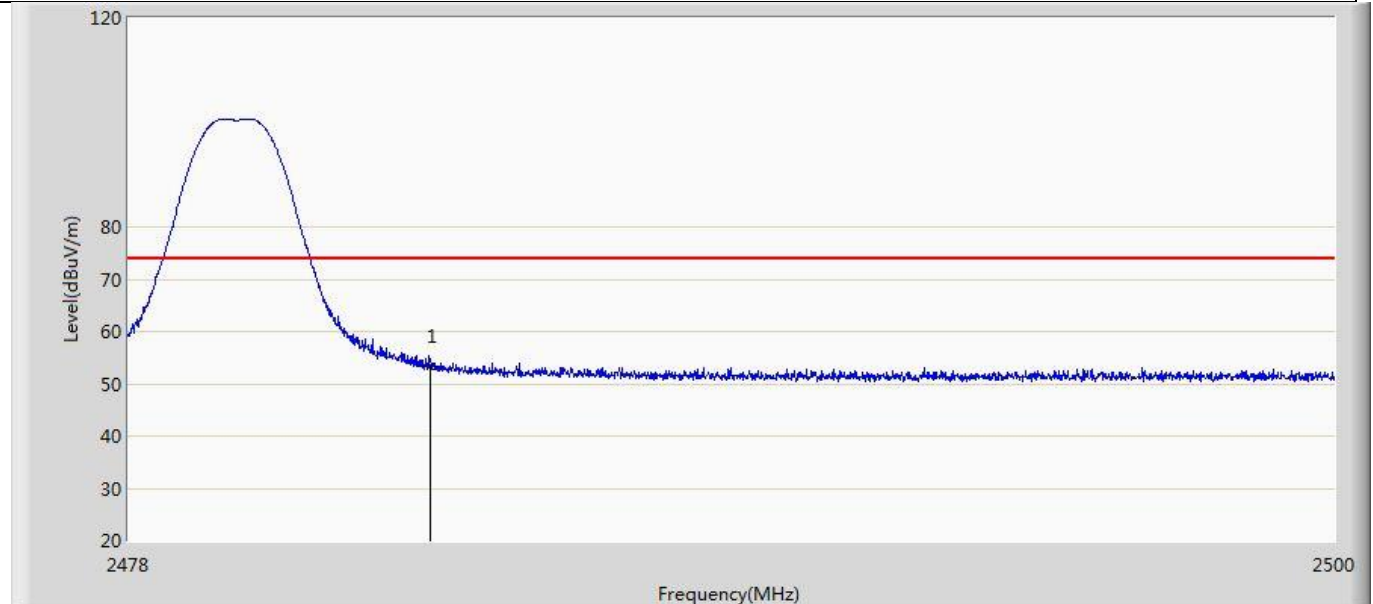

No	Mark	Frequency (MHz)	Measure Level (dBuV/m)	Reading Level (dBuV)	Over Limit (dB)	Limit (dBuV/m)	Factor (dB)	Type
1	*	2483.500	53.415	17.740	-20.585	74.000	35.675	PK

Profile: 21B0246R	Page No.: 19
Engineer: Juliuszhou	
Site: AC5	Time: 2021/05/25 - 20:42
Limit: FCC_Part15.209_RE(3m)	Margin: 0
Probe: Horn_3117_00123988_(1-18GHz)	Polarity: Horizontal
EUT: LED Device	Power: AC 120V/60Hz
Note: Mode 1:Transmit at 2480MHz by LE_1Mbps	

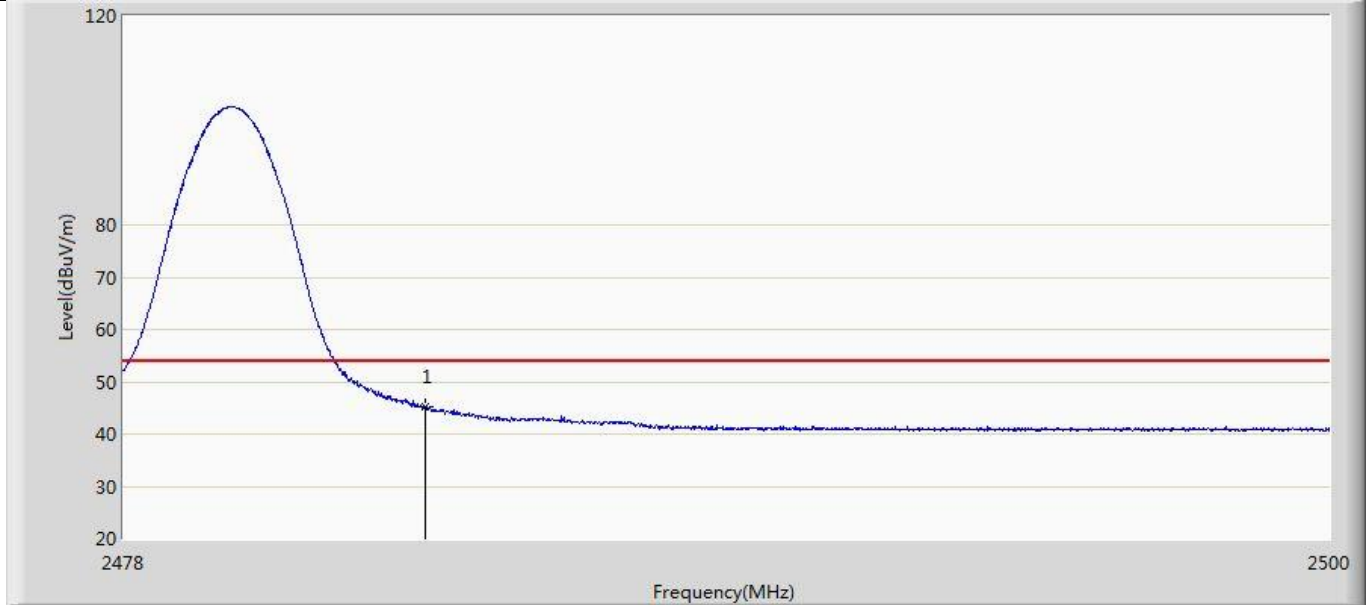

No	Mark	Frequency (MHz)	Measure Level (dBuV/m)	Reading Level (dBuV)	Over Limit (dB)	Limit (dBuV/m)	Factor (dB)	Type
1	*	2483.500	45.088	9.413	-8.912	54.000	35.675	AV

Profile: 21B0246R	Page No.: 20
Engineer: Juliuszhou	
Site: AC5	Time: 2021/05/25 - 20:43
Limit: FCC_Part15.209_RE(3m)	Margin: 0
Probe: Horn_3117_00123988_(1-18GHz)	Polarity: Horizontal
EUT: LED Device	Power: AC 120V/60Hz
Note: Mode 1:Transmit at 2480MHz by LE_1Mbps	

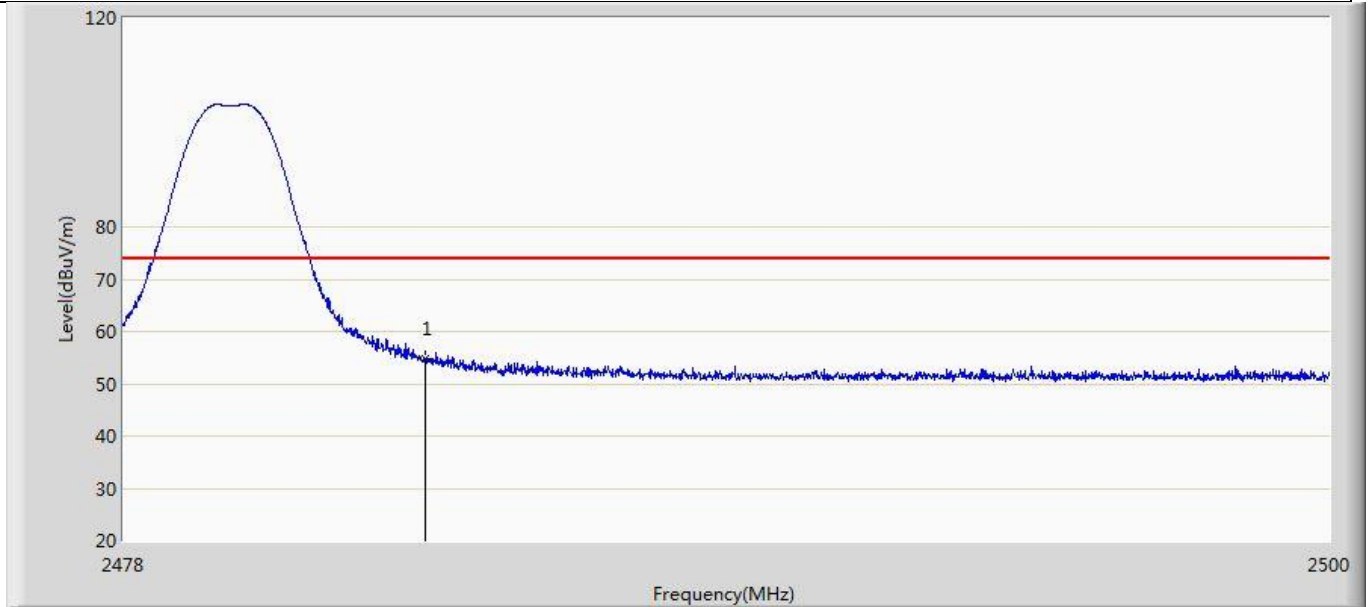

No	Mark	Frequency (MHz)	Measure Level (dBuV/m)	Reading Level (dBuV)	Over Limit (dB)	Limit (dBuV/m)	Factor (dB)	Type
1	*	2483.500	54.789	19.114	-19.211	74.000	35.675	PK

Profile: 21B0246R	Page No.: 5
Engineer: Juliuszhou	
Site: AC5	Time: 2021/05/25 - 20:22
Limit: FCC_Part15.209_RE(3m)	Margin: 0
Probe: Horn_3117_00123988_(1-18GHz)	Polarity: Vertical
EUT: LED Device	Power: AC 120V/60Hz
Note: Mode 2:Transmit at 2402MHz by LE_2Mbps	

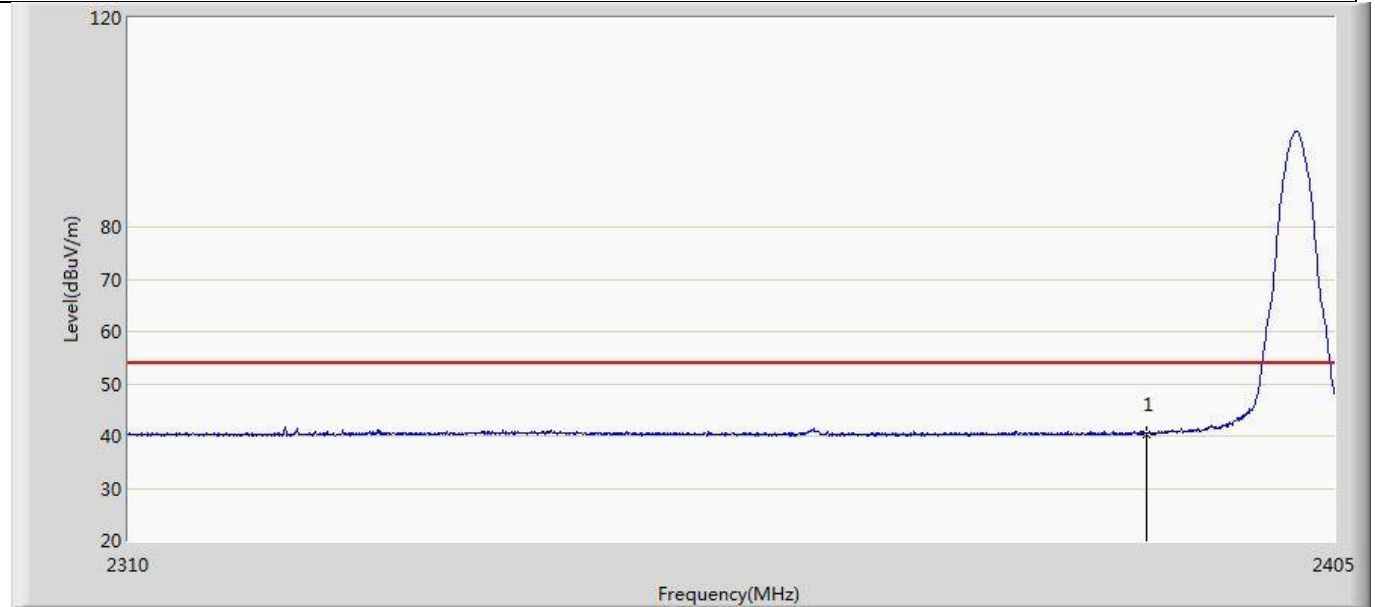

No	Mark	Frequency (MHz)	Measure Level (dBuV/m)	Reading Level (dBuV)	Over Limit (dB)	Limit (dBuV/m)	Factor (dB)	Type
1	*	2390.000	40.418	4.959	-13.582	54.000	35.459	AV

Profile: 21B0246R	Page No.: 6
Engineer: Juliuszhou	
Site: AC5	Time: 2021/05/25 - 20:23
Limit: FCC_Part15.209_RE(3m)	Margin: 0
Probe: Horn_3117_00123988_(1-18GHz)	Polarity: Vertical
EUT: LED Device	Power: AC 120V/60Hz
Note: Mode 2:Transmit at 2402MHz by LE_2Mbps	

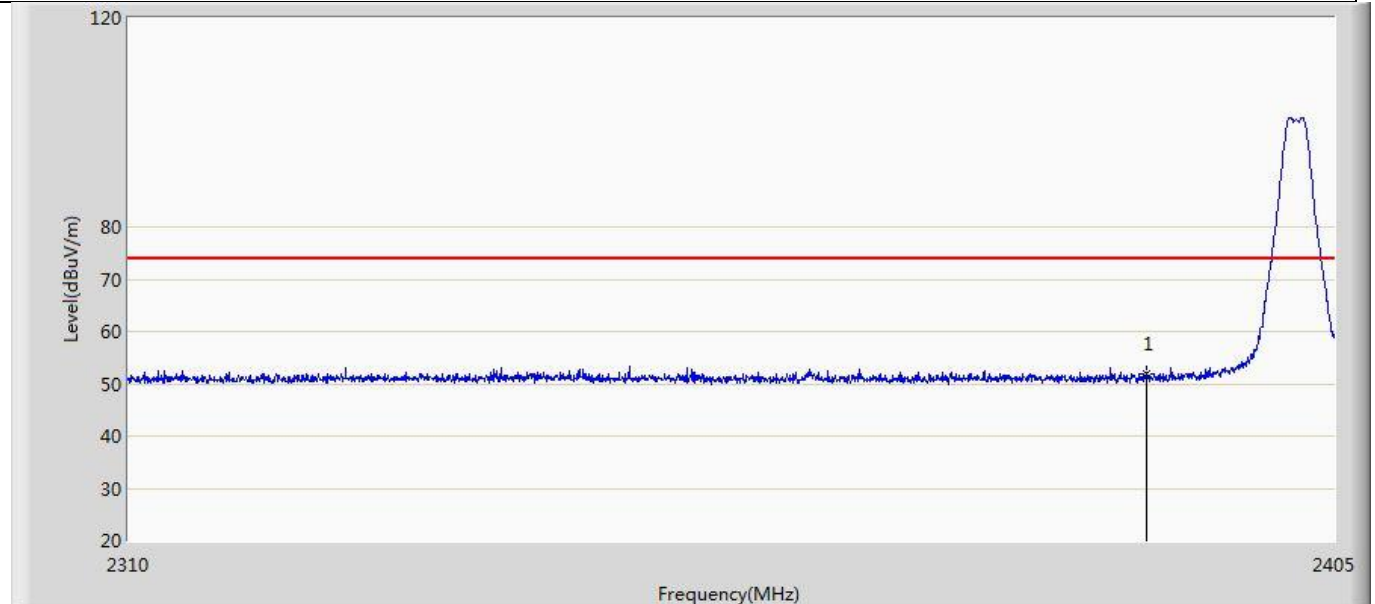

No	Mark	Frequency (MHz)	Measure Level (dBuV/m)	Reading Level (dBuV)	Over Limit (dB)	Limit (dBuV/m)	Factor (dB)	Type
1	*	2390.000	51.863	16.404	-22.137	74.000	35.459	PK

Profile: 21B0246R	Page No.: 7
Engineer: Juliuszhou	
Site: AC5	Time: 2021/05/25 - 20:25
Limit: FCC_Part15.209_RE(3m)	Margin: 0
Probe: Horn_3117_00123988_(1-18GHz)	Polarity: Horizontal
EUT: LED Device	Power: AC 120V/60Hz
Note: Mode 2:Transmit at 2402MHz by LE_2Mbps	

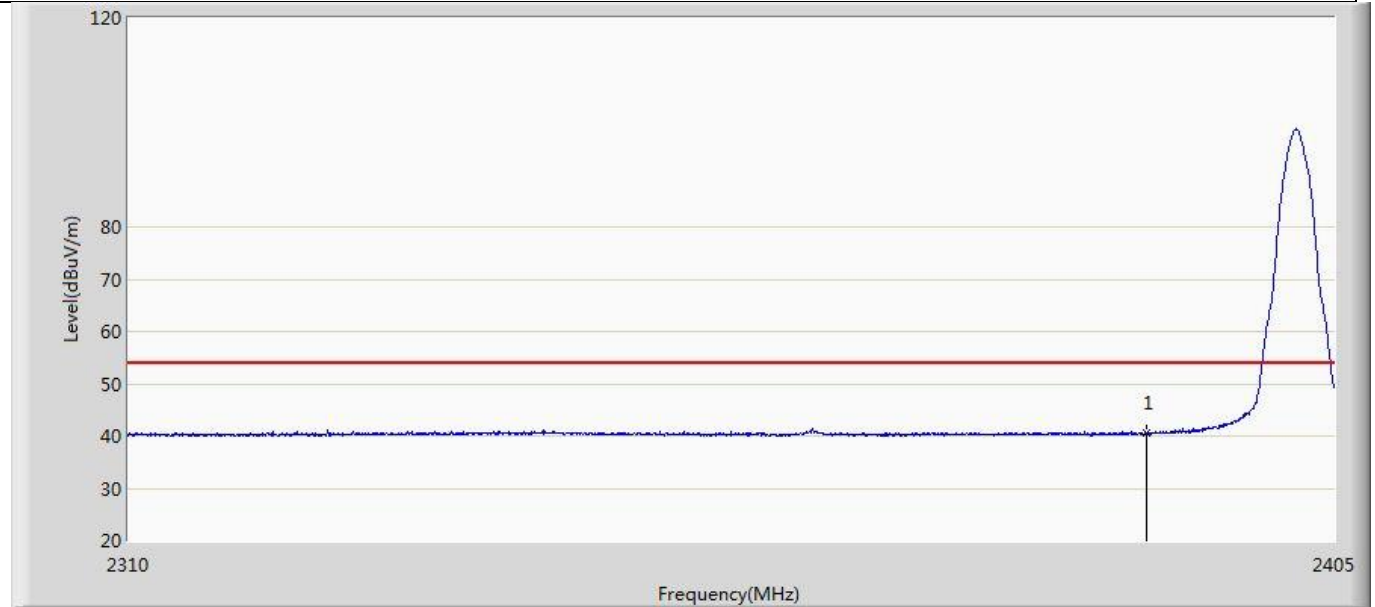

No	Mark	Frequency (MHz)	Measure Level (dBuV/m)	Reading Level (dBuV)	Over Limit (dB)	Limit (dBuV/m)	Factor (dB)	Type
1	*	2390.000	40.534	5.075	-13.466	54.000	35.459	AV

Profile: 21B0246R	Page No.: 8
Engineer: Juliuszhou	
Site: AC5	Time: 2021/05/25 - 20:26
Limit: FCC_Part15.209_RE(3m)	Margin: 0
Probe: Horn_3117_00123988_(1-18GHz)	Polarity: Horizontal
EUT: LED Device	Power: AC 120V/60Hz
Note: Mode 2:Transmit at 2402MHz by LE_2Mbps	

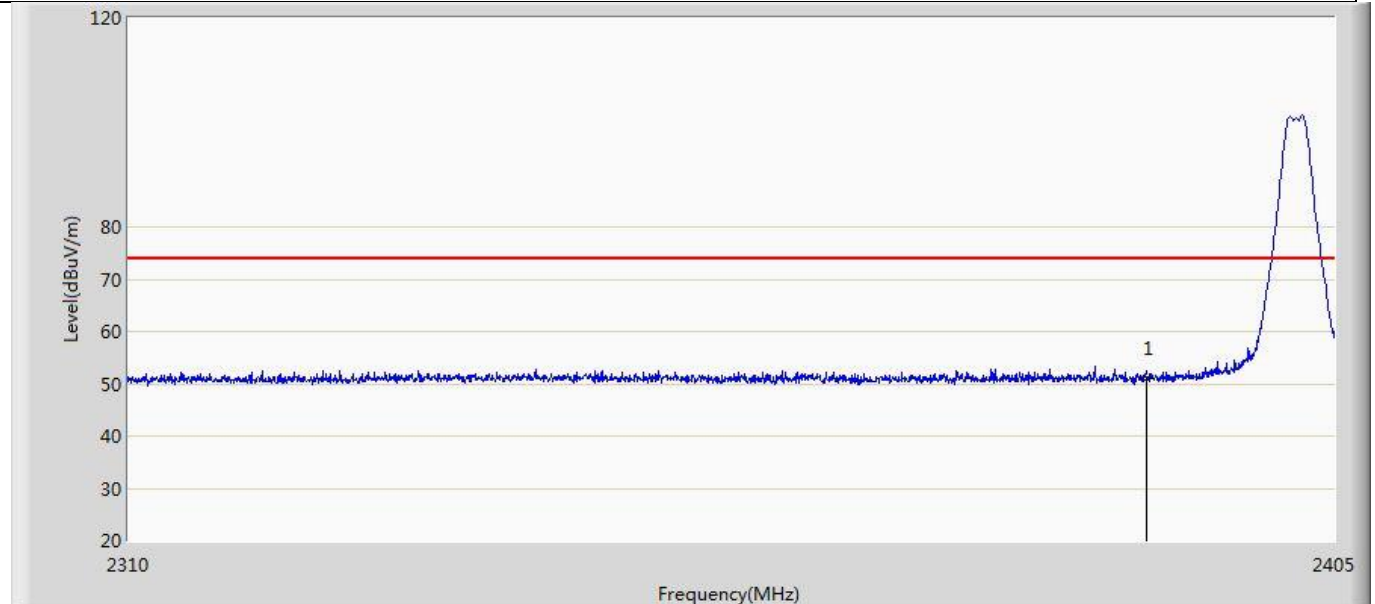

No	Mark	Frequency (MHz)	Measure Level (dBuV/m)	Reading Level (dBuV)	Over Limit (dB)	Limit (dBuV/m)	Factor (dB)	Type
1	*	2390.000	51.140	15.681	-22.860	74.000	35.459	PK

Profile: 21B0246R	Page No.: 21
Engineer: Juliuszhou	
Site: AC5	Time: 2021/05/25 - 20:44
Limit: FCC_Part15.209_RE(3m)	Margin: 0
Probe: Horn_3117_00123988_(1-18GHz)	Polarity: Vertical
EUT: LED Device	Power: AC 120V/60Hz
Note: Mode 2:Transmit at 2480MHz by LE_2Mbps	

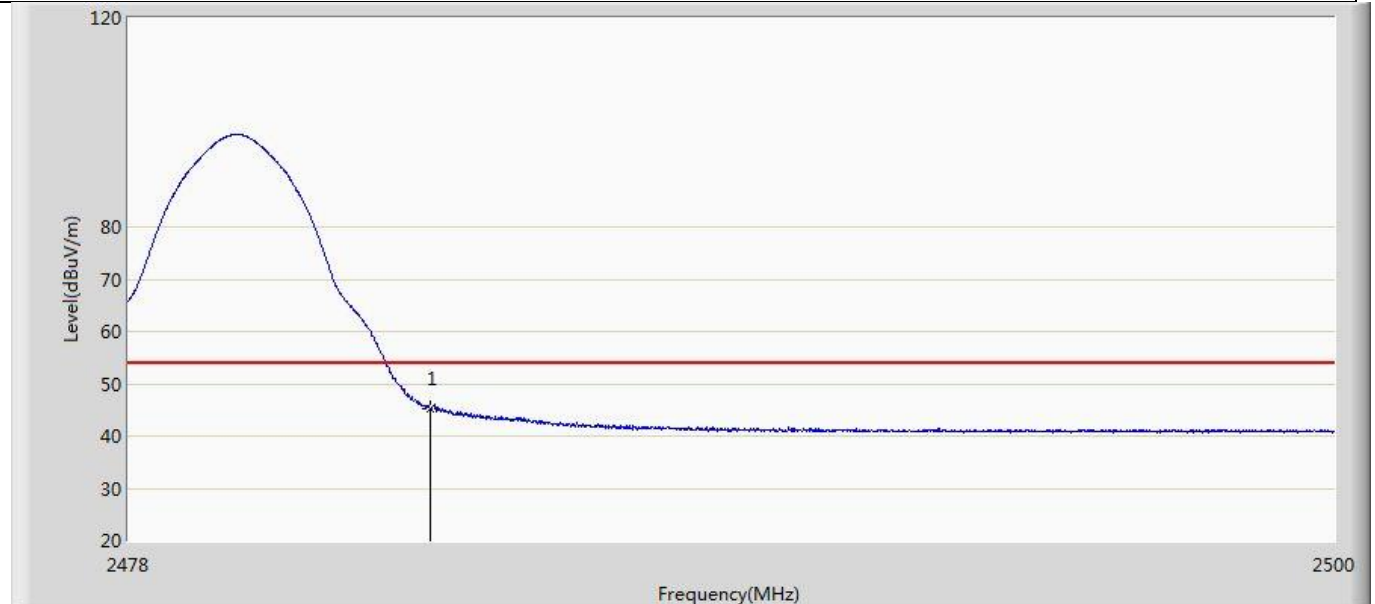

No	Mark	Frequency (MHz)	Measure Level (dBuV/m)	Reading Level (dBuV)	Over Limit (dB)	Limit (dBuV/m)	Factor (dB)	Type
1	*	2483.500	45.163	9.488	-8.837	54.000	35.675	AV

Profile: 21B0246R	Page No.: 22
Engineer: Juliuszhou	
Site: AC5	Time: 2021/05/25 - 20:45
Limit: FCC_Part15.209_RE(3m)	Margin: 0
Probe: Horn_3117_00123988_(1-18GHz)	Polarity: Vertical
EUT: LED Device	Power: AC 120V/60Hz
Note: Mode 2:Transmit at 2480MHz by LE_2Mbps	

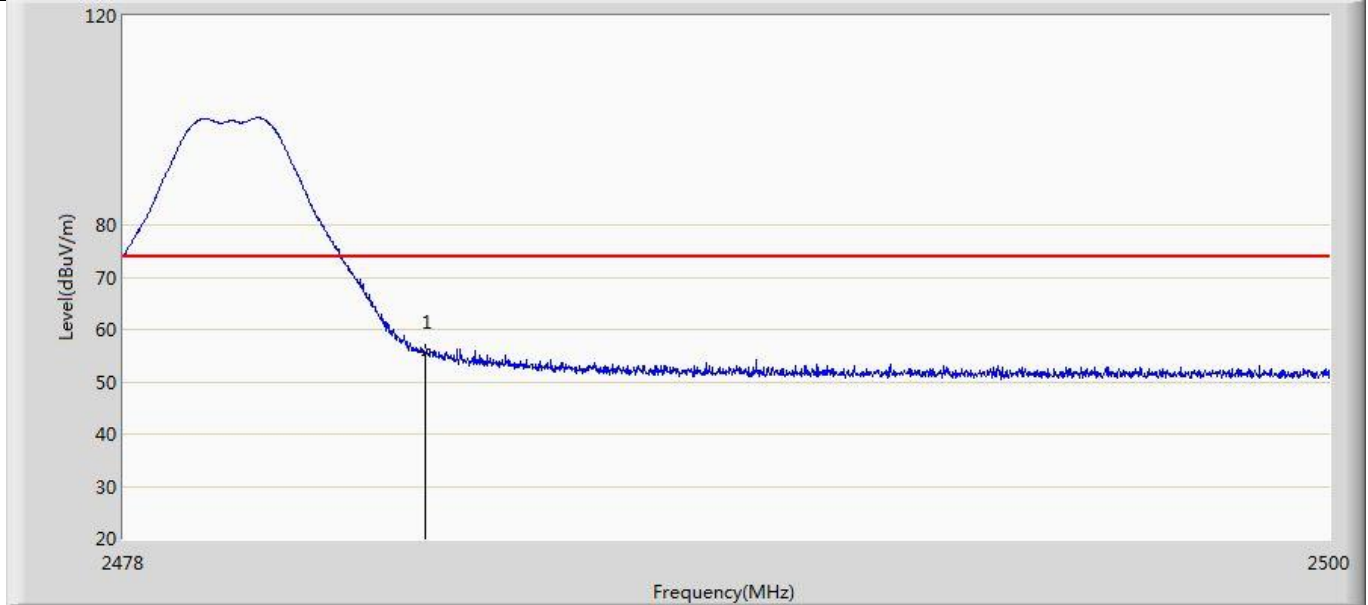

No	Mark	Frequency (MHz)	Measure Level (dBuV/m)	Reading Level (dBuV)	Over Limit (dB)	Limit (dBuV/m)	Factor (dB)	Type
1	*	2483.500	55.665	19.990	-18.335	74.000	35.675	PK

Profile: 21B0246R	Page No.: 23
Engineer: Juliuszhou	
Site: AC5	Time: 2021/05/25 - 20:46
Limit: FCC_Part15.209_RE(3m)	Margin: 0
Probe: Horn_3117_00123988_(1-18GHz)	Polarity: Horizontal
EUT: LED Device	Power: AC 120V/60Hz
Note: Mode 2:Transmit at 2480MHz by LE_2Mbps	

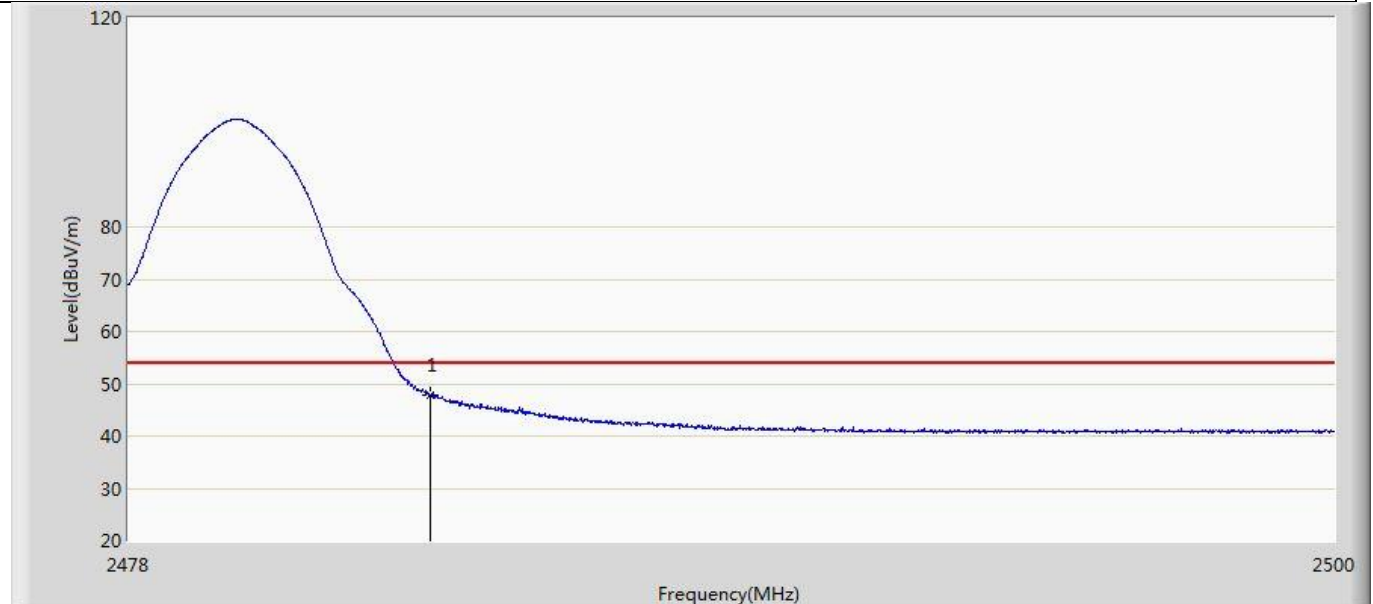

No	Mark	Frequency (MHz)	Measure Level (dBuV/m)	Reading Level (dBuV)	Over Limit (dB)	Limit (dBuV/m)	Factor (dB)	Type
1	*	2483.500	47.924	12.249	-6.076	54.000	35.675	AV

Profile: 21B0246R	Page No.: 24
Engineer: Juliuszhou	
Site: AC5	Time: 2021/05/25 - 20:47
Limit: FCC_Part15.209_RE(3m)	Margin: 0
Probe: Horn_3117_00123988_(1-18GHz)	Polarity: Horizontal
EUT: LED Device	Power: AC 120V/60Hz
Note: Mode 2:Transmit at 2480MHz by LE_2Mbps	

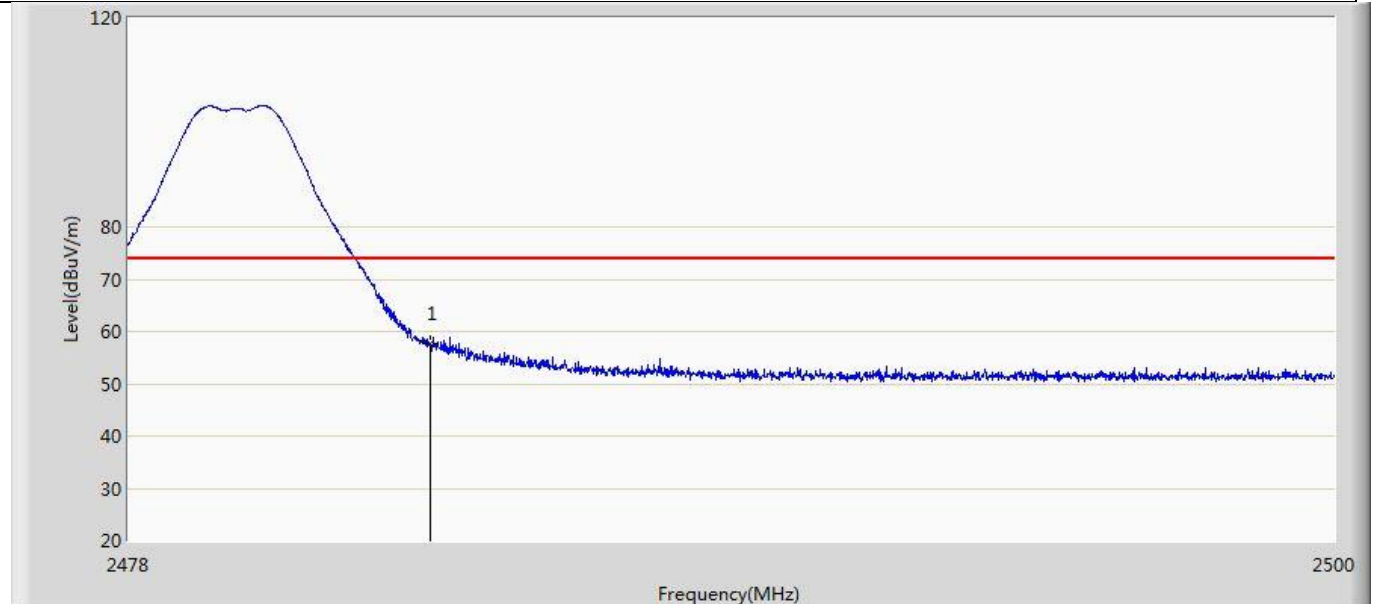

No	Mark	Frequency (MHz)	Measure Level (dBuV/m)	Reading Level (dBuV)	Over Limit (dB)	Limit (dBuV/m)	Factor (dB)	Type
1	*	2483.500	57.564	21.889	-16.436	74.000	35.675	PK

Profile: 21B0246R	Page No.: 9
Engineer: Juliuszhou	
Site: AC5	Time: 2021/05/25 - 20:27
Limit: FCC_Part15.209_RE(3m)	Margin: 0
Probe: Horn_3117_00123988_(1-18GHz)	Polarity: Vertical
EUT: LED Device	Power: AC 120V/60Hz
Note: Mode 3:Transmit at 2402MHz by Code S=8	

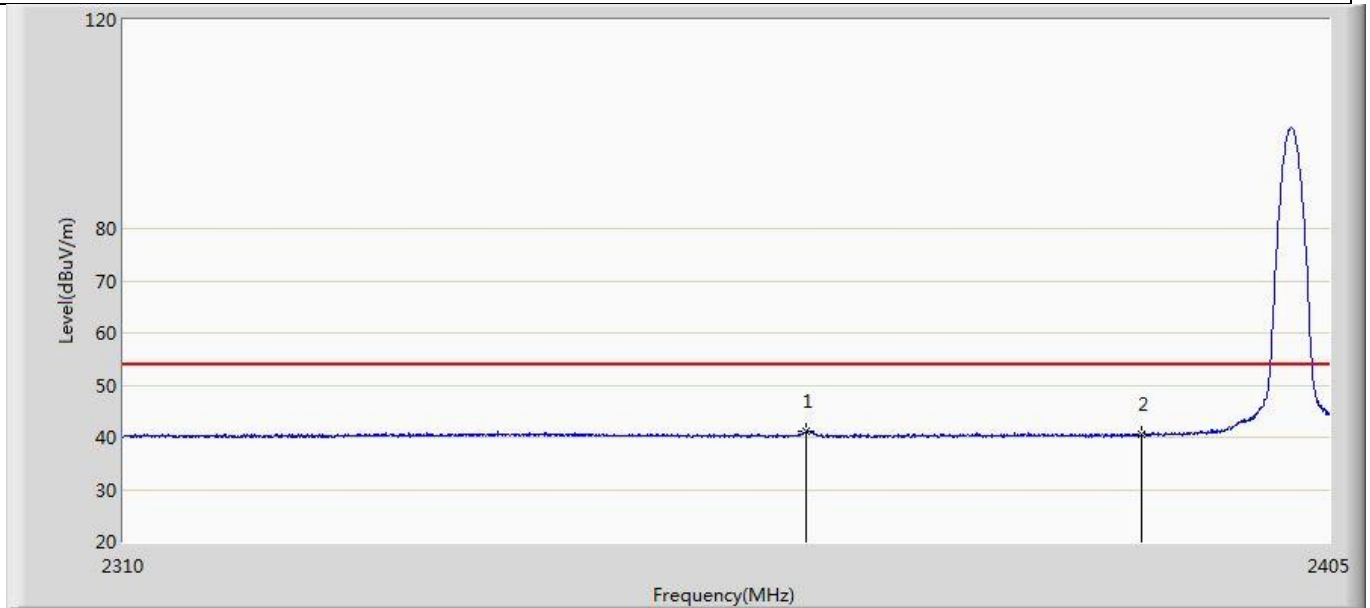

No	Mark	Frequency (MHz)	Measure Level (dBuV/m)	Reading Level (dBuV)	Over Limit (dB)	Limit (dBuV/m)	Factor (dB)	Type
1	*	2363.390	41.284	5.933	-12.716	54.000	35.351	AV
2		2390.000	40.459	5.000	-13.541	54.000	35.459	AV

Profile: 21B0246R	Page No.: 10
Engineer: Juliuszhou	
Site: AC5	Time: 2021/05/25 - 20:29
Limit: FCC_Part15.209_RE(3m)	Margin: 0
Probe: Horn_3117_00123988_(1-18GHz)	Polarity: Vertical
EUT: LED Device	Power: AC 120V/60Hz
Note: Mode 3:Transmit at 2402MHz by Code S=8	

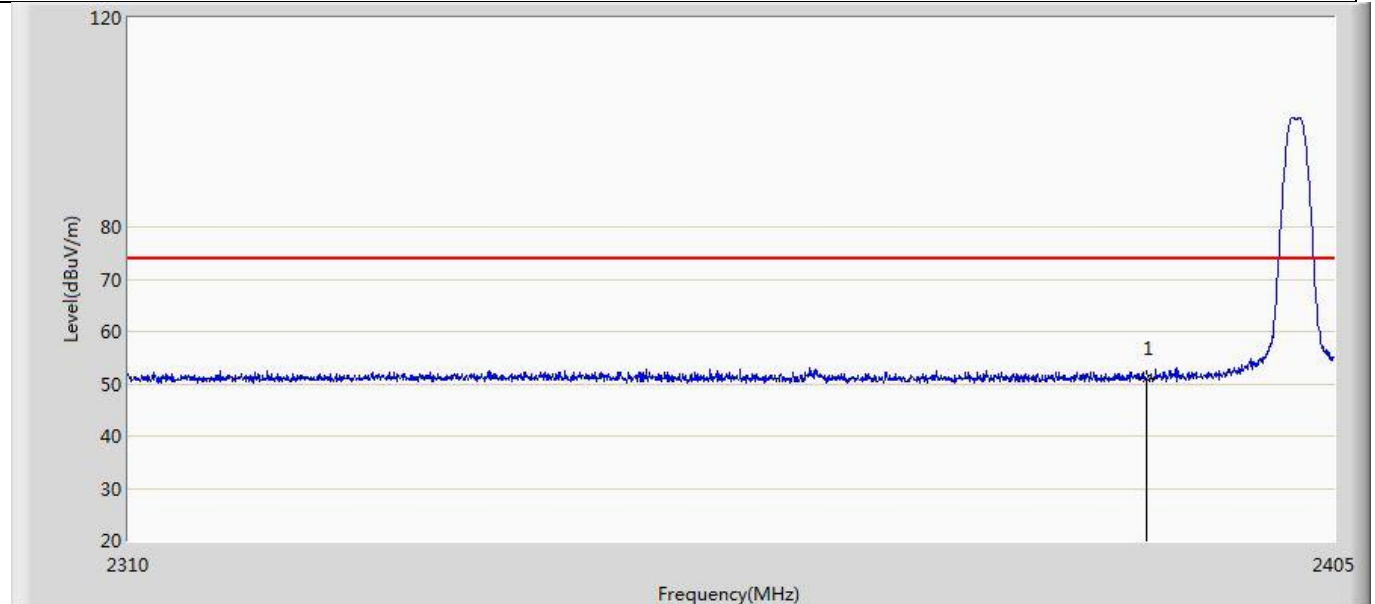

No	Mark	Frequency (MHz)	Measure Level (dBuV/m)	Reading Level (dBuV)	Over Limit (dB)	Limit (dBuV/m)	Factor (dB)	Type
1	*	2390.000	51.014	15.555	-22.986	74.000	35.459	PK

Profile: 21B0246R	Page No.: 11
Engineer: Juliuszhou	
Site: AC5	Time: 2021/05/25 - 20:30
Limit: FCC_Part15.209_RE(3m)	Margin: 0
Probe: Horn_3117_00123988_(1-18GHz)	Polarity: Horizontal
EUT: LED Device	Power: AC 120V/60Hz
Note: Mode 3:Transmit at 2402MHz by Code S=8	

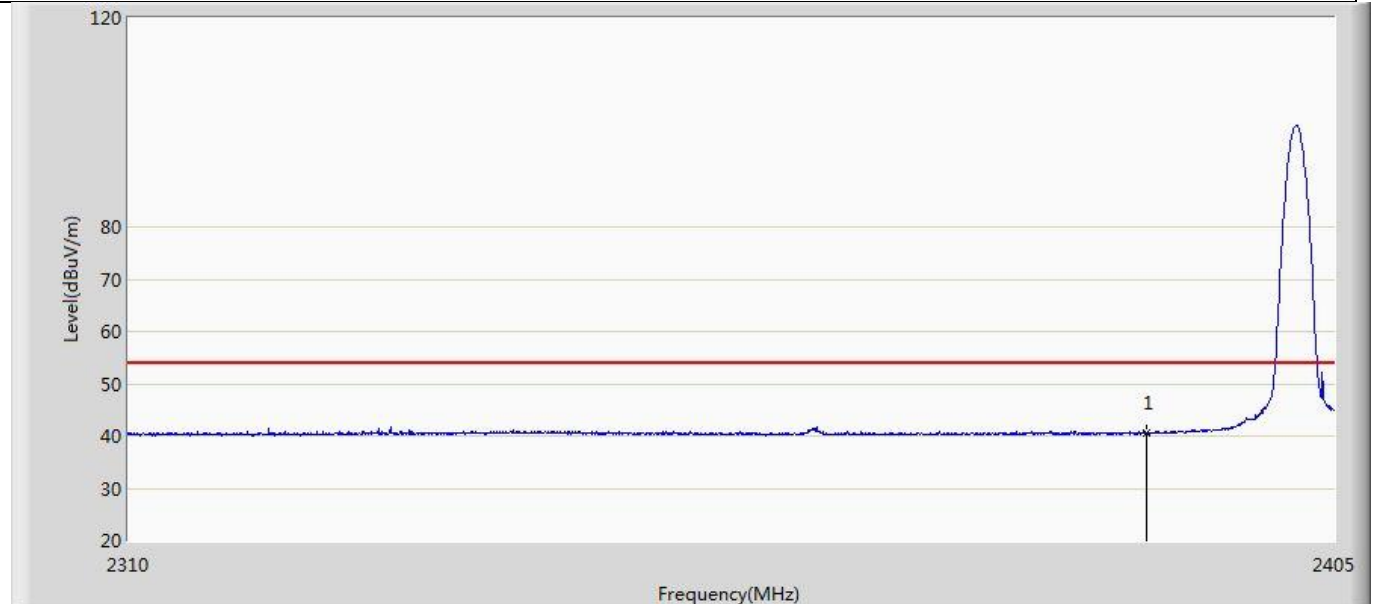

No	Mark	Frequency (MHz)	Measure Level (dBuV/m)	Reading Level (dBuV)	Over Limit (dB)	Limit (dBuV/m)	Factor (dB)	Type
1	*	2390.000	40.615	5.156	-13.385	54.000	35.459	AV

Profile: 21B0246R	Page No.: 12
Engineer: Juliuszhou	
Site: AC5	Time: 2021/05/25 - 20:31
Limit: FCC_Part15.209_RE(3m)	Margin: 0
Probe: Horn_3117_00123988_(1-18GHz)	Polarity: Horizontal
EUT: LED Device	Power: AC 120V/60Hz
Note: Mode 3:Transmit at 2402MHz by Code S=8	

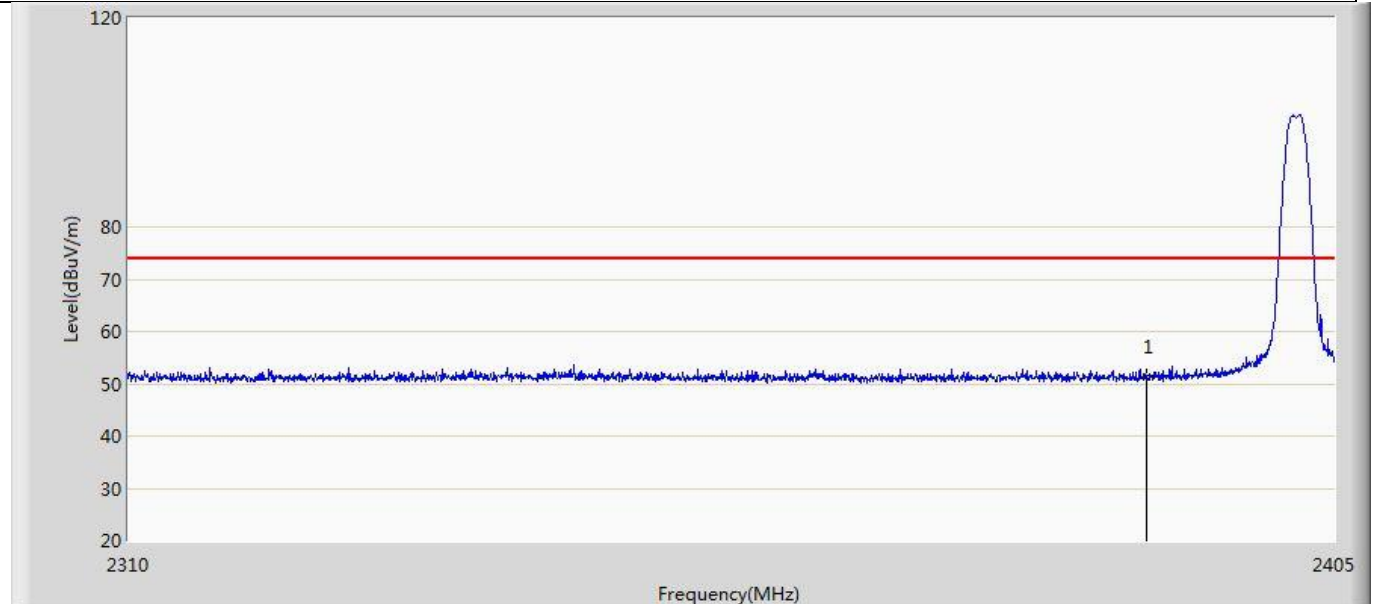

No	Mark	Frequency (MHz)	Measure Level (dBuV/m)	Reading Level (dBuV)	Over Limit (dB)	Limit (dBuV/m)	Factor (dB)	Type
1	*	2390.000	51.345	15.886	-22.655	74.000	35.459	PK

Profile: 21B0246R	Page No.: 25
Engineer: Juliuszhou	
Site: AC5	Time: 2021/05/25 - 20:48
Limit: FCC_Part15.209_RE(3m)	Margin: 0
Probe: Horn_3117_00123988_(1-18GHz)	Polarity: Vertical
EUT: LED Device	Power: AC 120V/60Hz
Note: Mode 3:Transmit at 2480MHz by Code S=8	

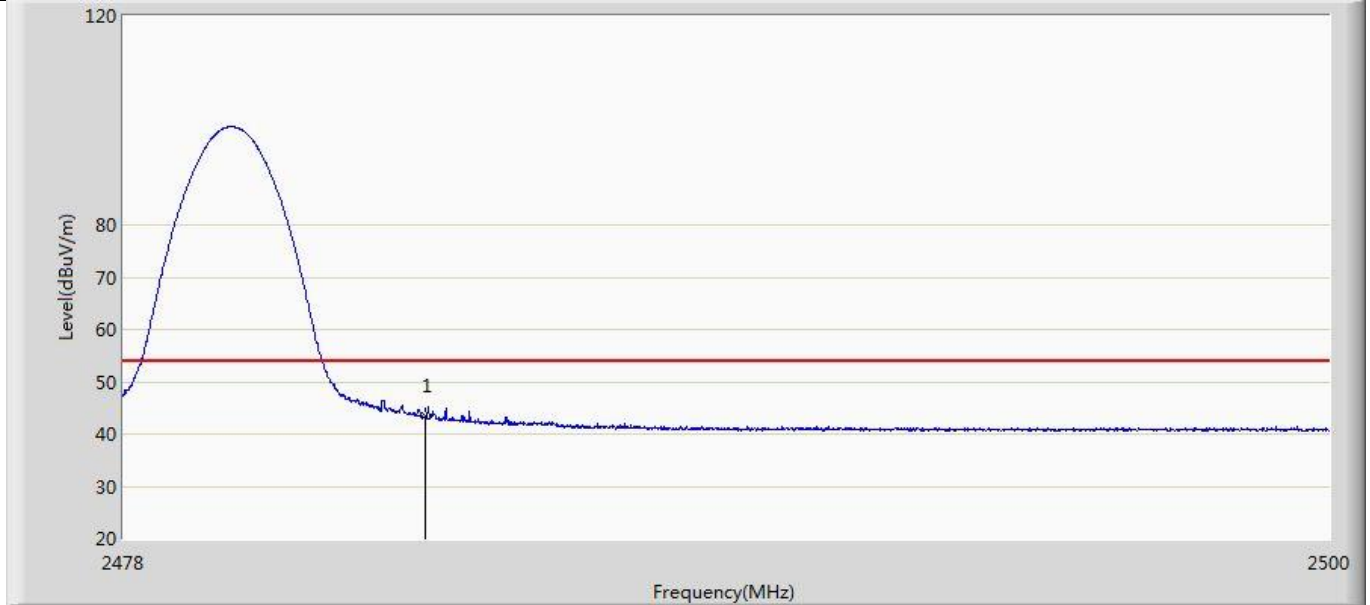

No	Mark	Frequency (MHz)	Measure Level (dBuV/m)	Reading Level (dBuV)	Over Limit (dB)	Limit (dBuV/m)	Factor (dB)	Type
1	*	2483.500	43.428	7.753	-10.572	54.000	35.675	AV

Profile: 21B0246R	Page No.: 26
Engineer: Juliuszhou	
Site: AC5	Time: 2021/05/25 - 20:50
Limit: FCC_Part15.209_RE(3m)	Margin: 0
Probe: Horn_3117_00123988_(1-18GHz)	Polarity: Vertical
EUT: LED Device	Power: AC 120V/60Hz
Note: Mode 3:Transmit at 2480MHz by Code S=8	

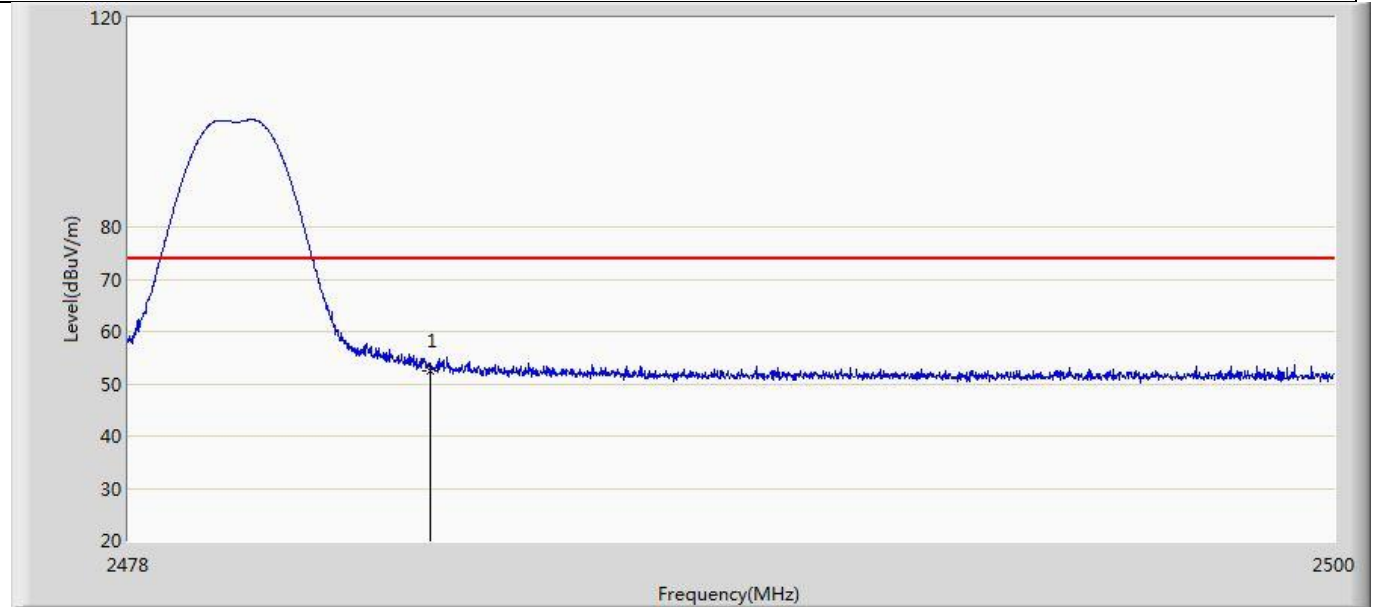

No	Mark	Frequency (MHz)	Measure Level (dBuV/m)	Reading Level (dBuV)	Over Limit (dB)	Limit (dBuV/m)	Factor (dB)	Type
1	*	2483.500	52.487	16.812	-21.513	74.000	35.675	PK

Profile: 21B0246R	Page No.: 27
Engineer: Juliuszhou	
Site: AC5	Time: 2021/05/25 - 20:50
Limit: FCC_Part15.209_RE(3m)	Margin: 0
Probe: Horn_3117_00123988_(1-18GHz)	Polarity: Horizontal
EUT: LED Device	Power: AC 120V/60Hz
Note: Mode 3:Transmit at 2480MHz by Code S=8	

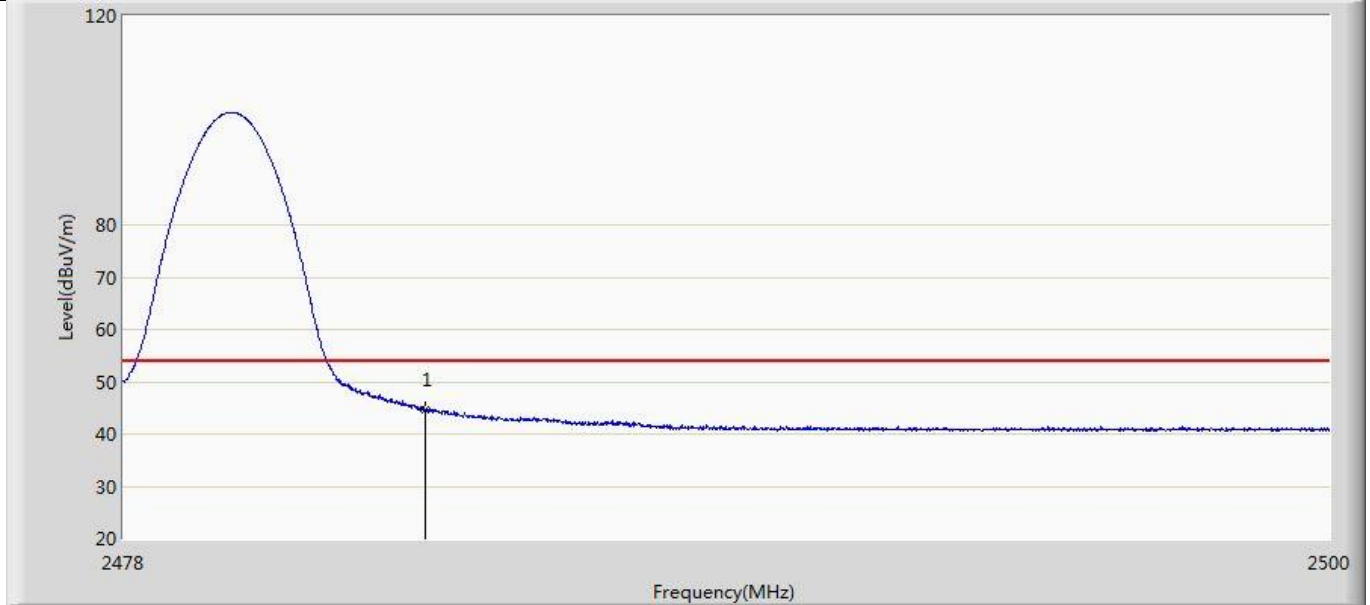

No	Mark	Frequency (MHz)	Measure Level (dBuV/m)	Reading Level (dBuV)	Over Limit (dB)	Limit (dBuV/m)	Factor (dB)	Type
1	*	2483.500	44.566	8.891	-9.434	54.000	35.675	AV

Profile: 21B0246R	Page No.: 28
Engineer: Juliuszhou	
Site: AC5	Time: 2021/05/25 - 20:51
Limit: FCC_Part15.209_RE(3m)	Margin: 0
Probe: Horn_3117_00123988_(1-18GHz)	Polarity: Horizontal
EUT: LED Device	Power: AC 120V/60Hz
Note: Mode 3:Transmit at 2480MHz by Code S=8	

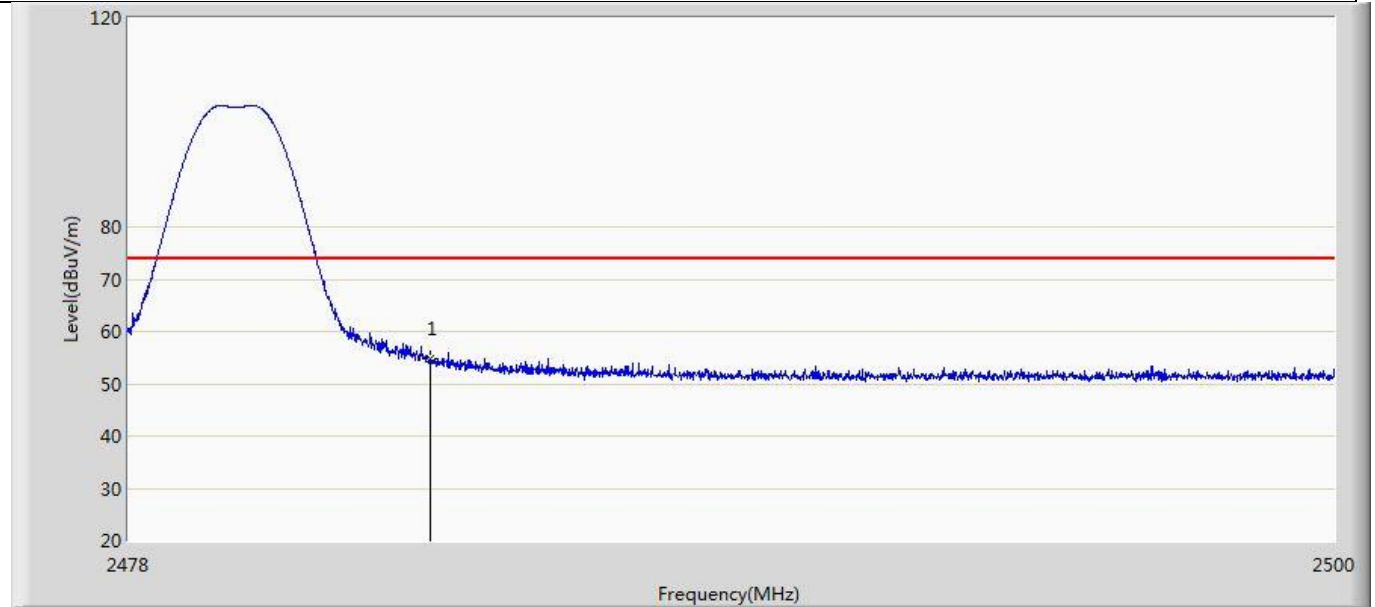

No	Mark	Frequency (MHz)	Measure Level (dBuV/m)	Reading Level (dBuV)	Over Limit (dB)	Limit (dBuV/m)	Factor (dB)	Type
1	*	2483.500	54.730	19.055	-19.270	74.000	35.675	PK

Profile: 21B0246R	Page No.: 13
Engineer: Juliuszhou	
Site: AC5	Time: 2021/05/25 - 20:33
Limit: FCC_Part15.209_RE(3m)	Margin: 0
Probe: Horn_3117_00123988_(1-18GHz)	Polarity: Vertical
EUT: LED Device	Power: AC 120V/60Hz
Note: Mode 4:Transmit at 2402MHz by Code S=2	

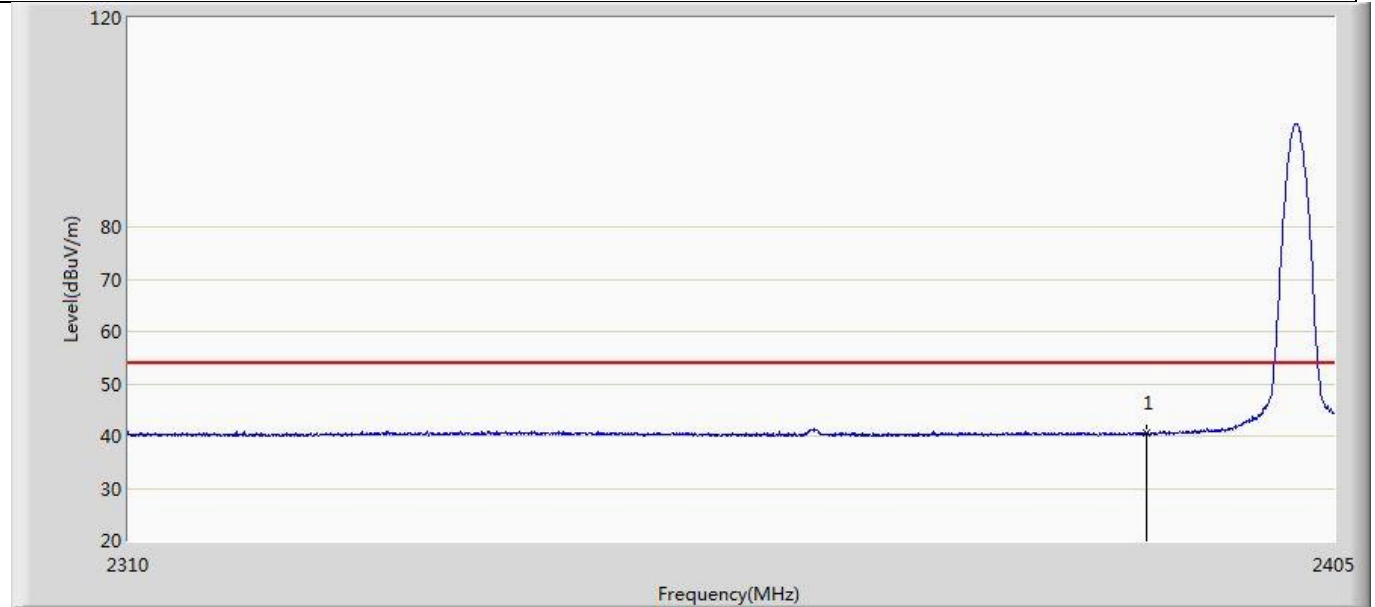

No	Mark	Frequency (MHz)	Measure Level (dBuV/m)	Reading Level (dBuV)	Over Limit (dB)	Limit (dBuV/m)	Factor (dB)	Type
1	*	2390.000	40.652	5.193	-13.348	54.000	35.459	AV

Profile: 21B0246R	Page No.: 14
Engineer: Juliuszhou	
Site: AC5	Time: 2021/05/25 - 20:35
Limit: FCC_Part15.209_RE(3m)	Margin: 0
Probe: Horn_3117_00123988_(1-18GHz)	Polarity: Vertical
EUT: LED Device	Power: AC 120V/60Hz
Note: Mode 4:Transmit at 2402MHz by Code S=2	

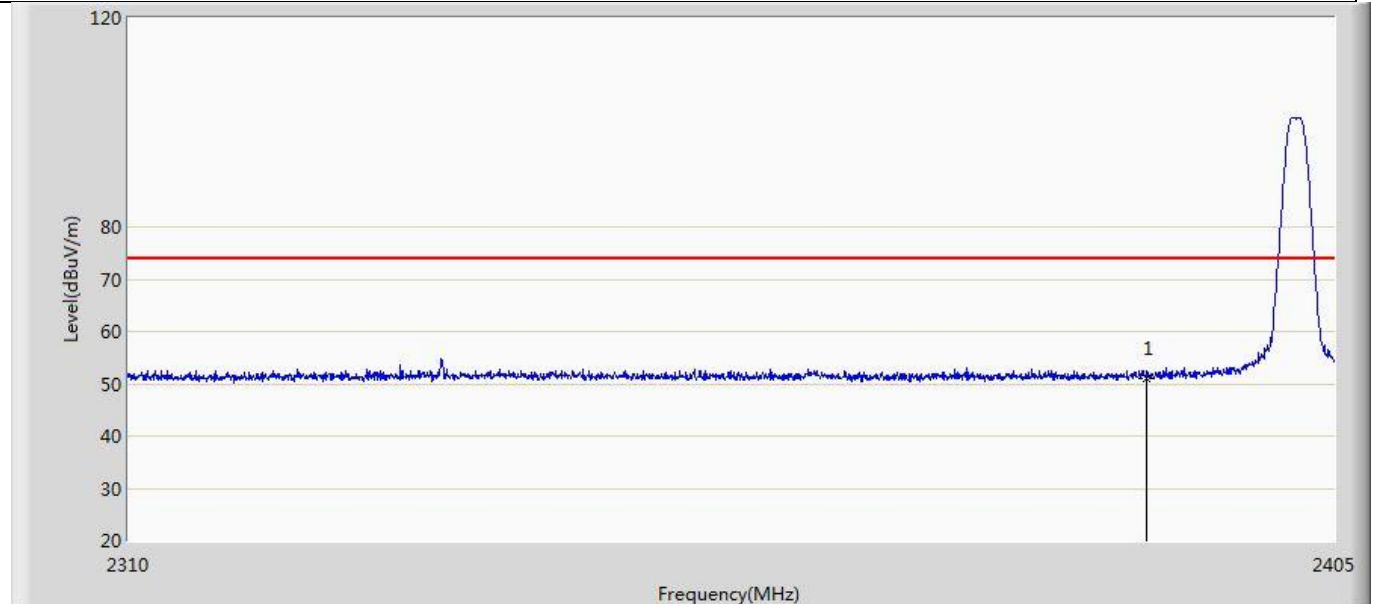

No	Mark	Frequency (MHz)	Measure Level (dBuV/m)	Reading Level (dBuV)	Over Limit (dB)	Limit (dBuV/m)	Factor (dB)	Type
1	*	2390.000	51.096	15.637	-22.904	74.000	35.459	PK

Profile: 21B0246R	Page No.: 15
Engineer: Juliuszhou	
Site: AC5	Time: 2021/05/25 - 20:36
Limit: FCC_Part15.209_RE(3m)	Margin: 0
Probe: Horn_3117_00123988_(1-18GHz)	Polarity: Horizontal
EUT: LED Device	Power: AC 120V/60Hz
Note: Mode 4:Transmit at 2402MHz by Code S=2	

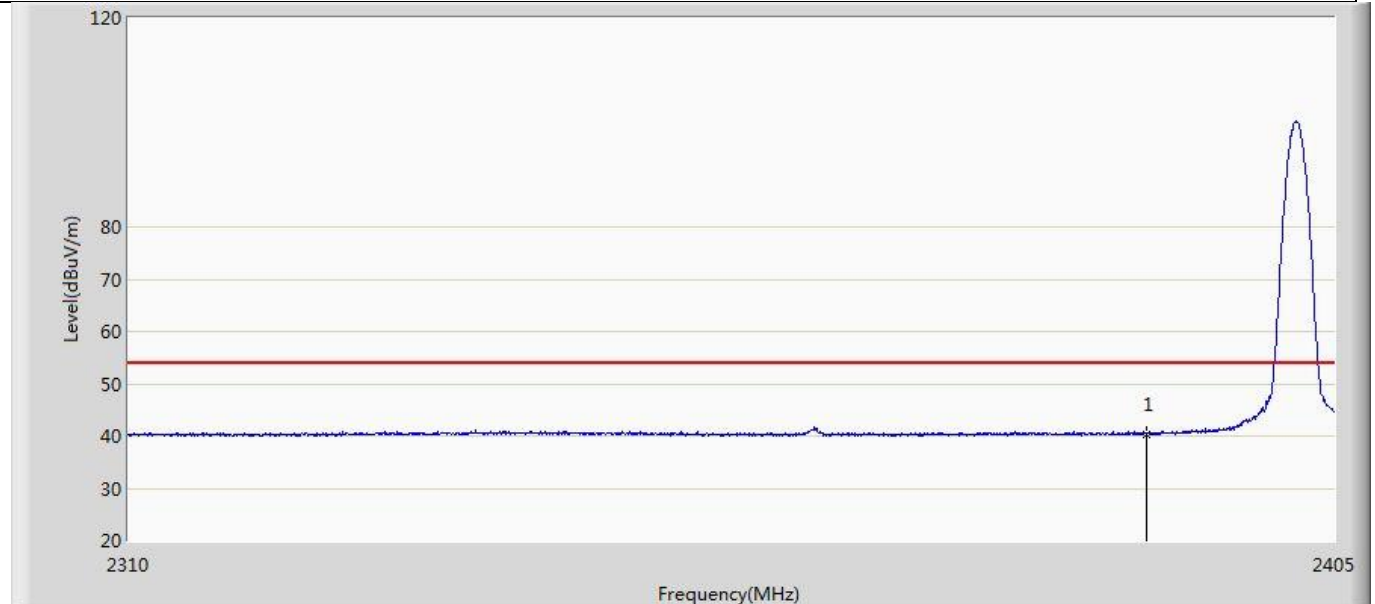

No	Mark	Frequency (MHz)	Measure Level (dBuV/m)	Reading Level (dBuV)	Over Limit (dB)	Limit (dBuV/m)	Factor (dB)	Type
1	*	2390.000	40.362	4.903	-13.638	54.000	35.459	AV

Profile: 21B0246R	Page No.: 16
Engineer: Juliuszhou	
Site: AC5	Time: 2021/05/25 - 20:37
Limit: FCC_Part15.209_RE(3m)	Margin: 0
Probe: Horn_3117_00123988_(1-18GHz)	Polarity: Horizontal
EUT: LED Device	Power: AC 120V/60Hz
Note: Mode 4:Transmit at 2402MHz by Code S=2	

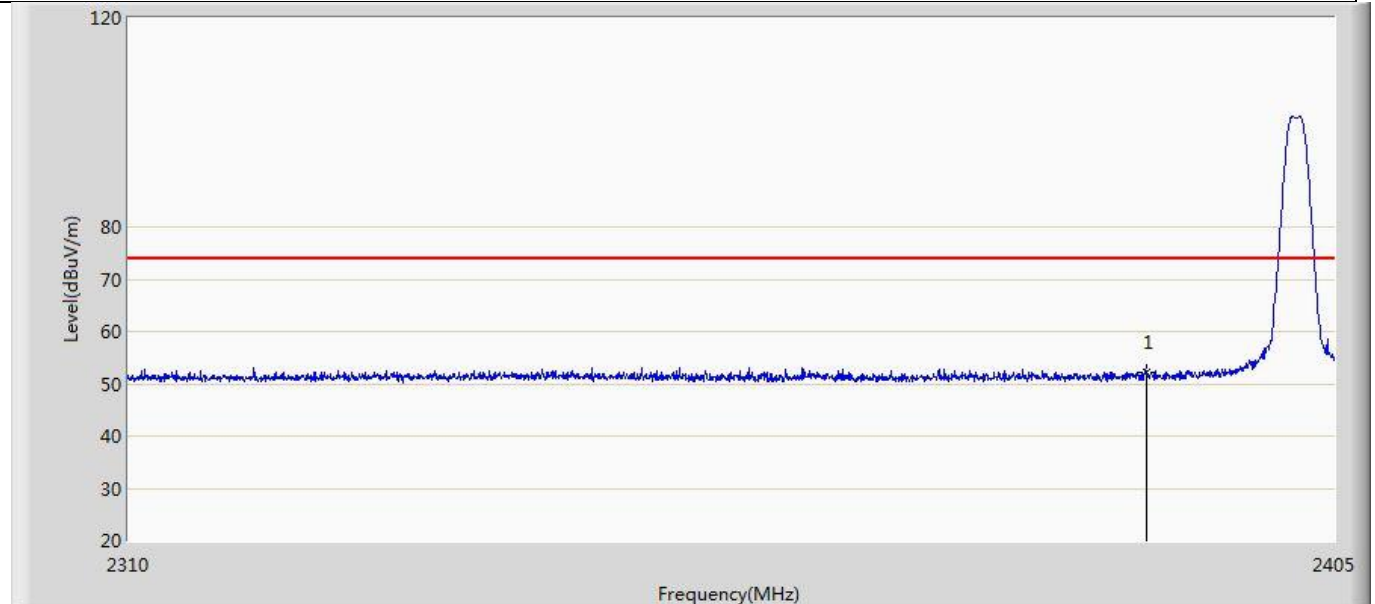

No	Mark	Frequency (MHz)	Measure Level (dBuV/m)	Reading Level (dBuV)	Over Limit (dB)	Limit (dBuV/m)	Factor (dB)	Type
1	*	2390.000	52.243	16.784	-21.757	74.000	35.459	PK

Profile: 21B0246R	Page No.: 29
Engineer: Juliuszhou	
Site: AC5	Time: 2021/05/25 - 20:52
Limit: FCC_Part15.209_RE(3m)	Margin: 0
Probe: Horn_3117_00123988_(1-18GHz)	Polarity: Vertical
EUT: LED Device	Power: AC 120V/60Hz
Note: Mode 4:Transmit at 2480MHz by Code S=2	

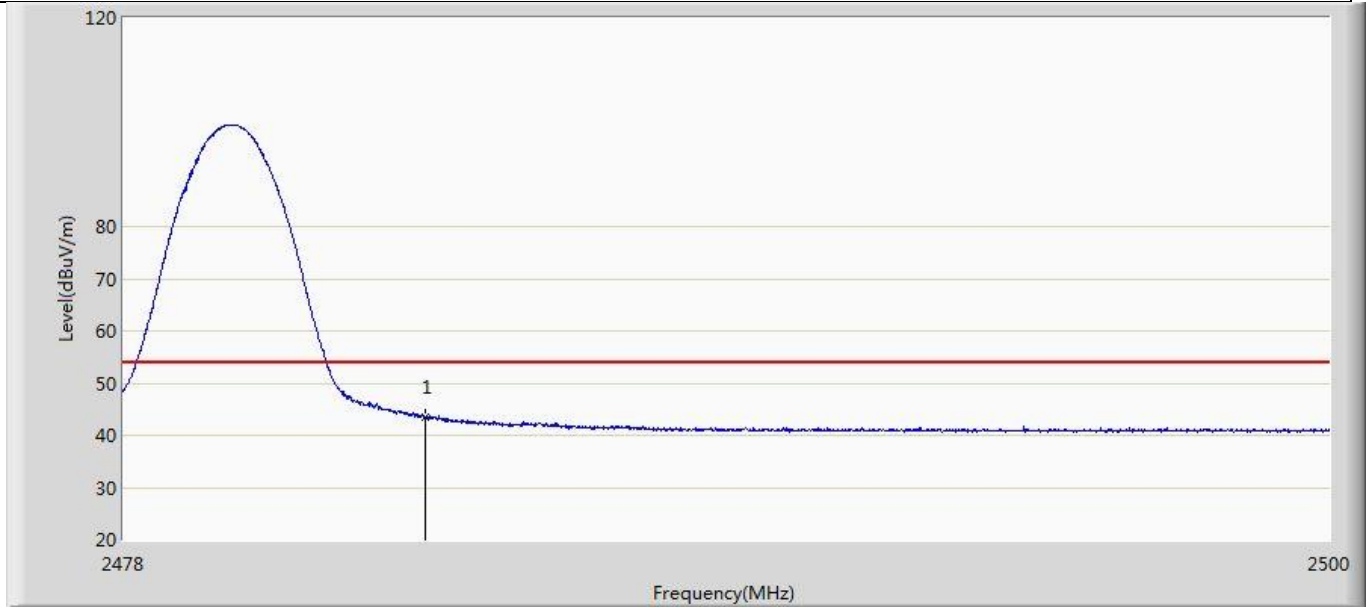

No	Mark	Frequency (MHz)	Measure Level (dBuV/m)	Reading Level (dBuV)	Over Limit (dB)	Limit (dBuV/m)	Factor (dB)	Type
1	*	2483.500	43.516	7.841	-10.484	54.000	35.675	AV

Profile: 21B0246R	Page No.: 30
Engineer: Juliuszhou	
Site: AC5	Time: 2021/05/25 - 20:53
Limit: FCC_Part15.209_RE(3m)	Margin: 0
Probe: Horn_3117_00123988_(1-18GHz)	Polarity: Vertical
EUT: LED Device	Power: AC 120V/60Hz
Note: Mode 4:Transmit at 2480MHz by Code S=2	

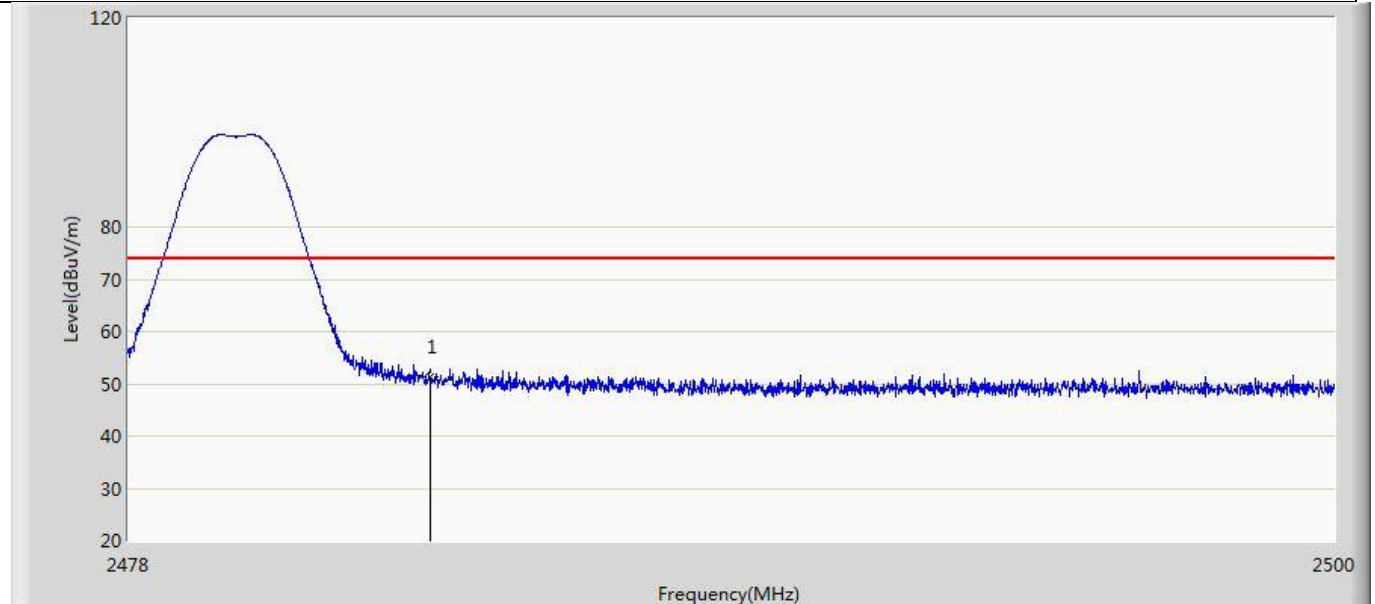

No	Mark	Frequency (MHz)	Measure Level (dBuV/m)	Reading Level (dBuV)	Over Limit (dB)	Limit (dBuV/m)	Factor (dB)	Type
1	*	2483.500	51.388	15.713	-22.612	74.000	35.675	PK

Profile: 21B0246R	Page No.: 31
Engineer: Juliuszhou	
Site: AC5	Time: 2021/05/25 - 20:54
Limit: FCC_Part15.209_RE(3m)	Margin: 0
Probe: Horn_3117_00123988_(1-18GHz)	Polarity: Horizontal
EUT: LED Device	Power: AC 120V/60Hz
Note: Mode 4:Transmit at 2480MHz by Code S=2	

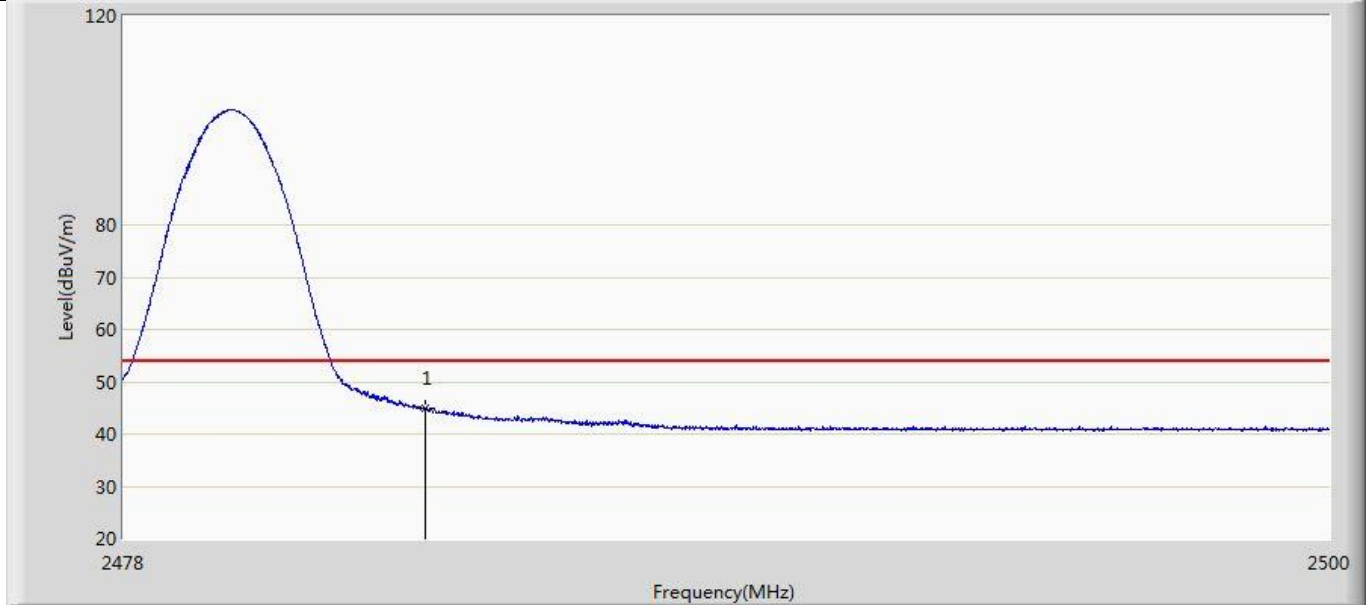

No	Mark	Frequency (MHz)	Measure Level (dBuV/m)	Reading Level (dBuV)	Over Limit (dB)	Limit (dBuV/m)	Factor (dB)	Type
1	*	2483.500	44.935	9.260	-9.065	54.000	35.675	AV

Profile: 21B0246R	Page No.: 32
Engineer: Juliuszhou	
Site: AC5	Time: 2021/05/25 - 20:55
Limit: FCC_Part15.209_RE(3m)	Margin: 0
Probe: Horn_3117_00123988_(1-18GHz)	Polarity: Horizontal
EUT: LED Device	Power: AC 120V/60Hz
Note: Mode 4:Transmit at 2480MHz by Code S=2	

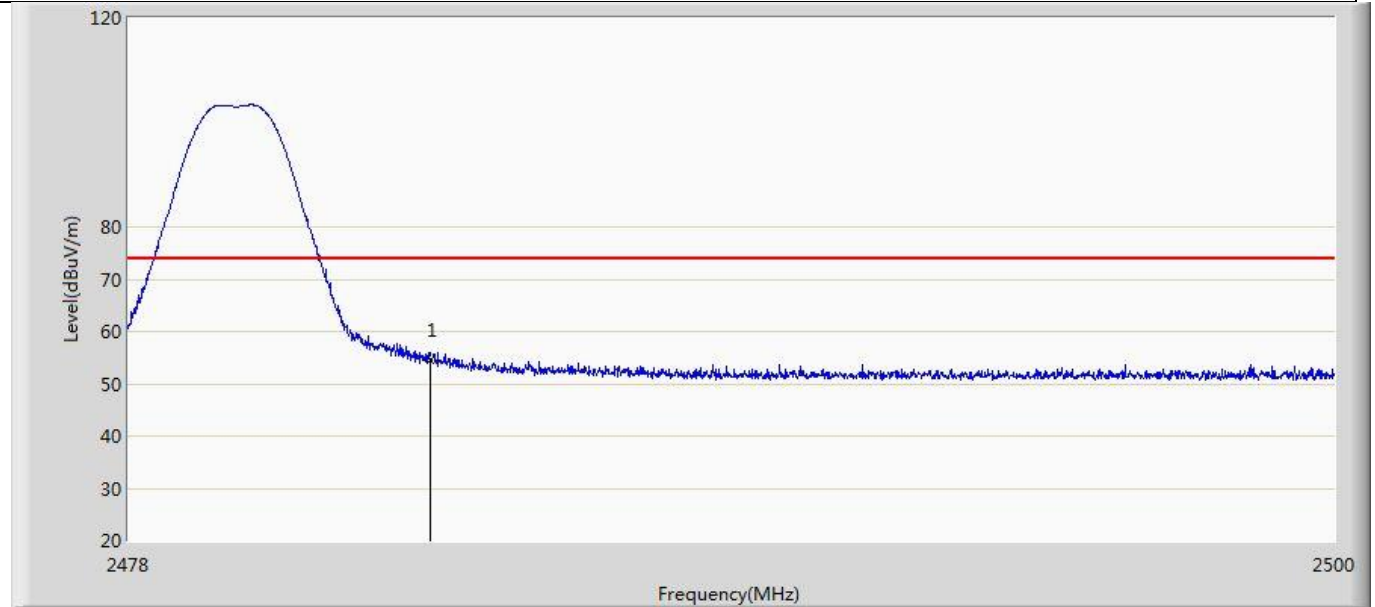

No	Mark	Frequency (MHz)	Measure Level (dBuV/m)	Reading Level (dBuV)	Over Limit (dB)	Limit (dBuV/m)	Factor (dB)	Type
1	*	2483.500	54.423	18.748	-19.577	74.000	35.675	PK

4.6 DTS Bandwidth	VERDICT: PASS
--------------------------	----------------------

4.6.1 Limit

Standard	FCC Part 15 Subpart C Paragraph 15.247 (a)(2)
-----------------	---

Systems using digital modulation techniques operate in the 2400-2483.5 MHz. The minimum 6 dB bandwidth shall be at least 500 kHz

4.6.2 Test Setup

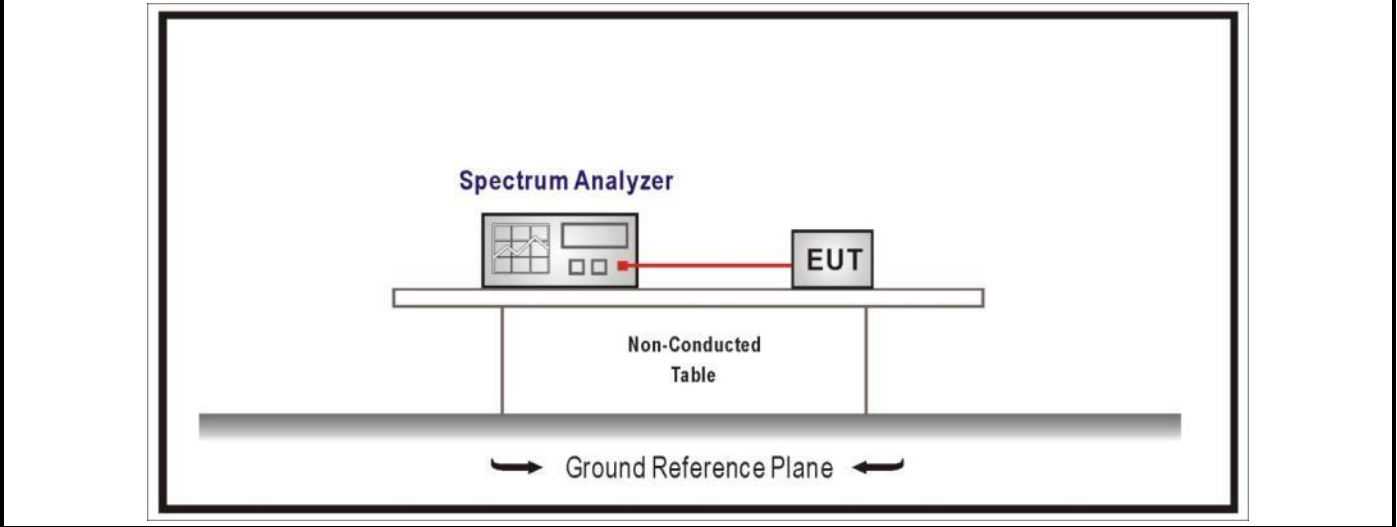

4.6.3 Test Procedure

	Reference Rule	Chapter	Description
<input checked="" type="checkbox"/>	ANSI C63.10	11.8	DTS bandwidth
<input type="checkbox"/>	ANSI C63.10	11.8.1	Option 1
<input checked="" type="checkbox"/>	ANSI C63.10	11.8.2	Option 2

4.6.4 Test Data

Mode	CH.	Test Freq. (MHz)	99% Occupied Bandwidth (kHz)	6dB Occupied Bandwidth (kHz)	Limit (kHz)	Result
1	00	2402	1076.7	693.9	>500	Pass
	19	2440	1075.4	690.9	>500	Pass
	39	2480	1071.4	683.2	>500	Pass
2	00	2402	2184.3	1382	>500	Pass
	19	2440	2182.9	1381	>500	Pass
	39	2480	2184.9	1377	>500	Pass
3	00	2402	1142.0	734.3	>500	Pass
	19	2440	1140.4	730.0	>500	Pass
	39	2480	1136.3	733.5	>500	Pass
4	00	2402	1138.1	787.1	>500	Pass
	19	2440	1136.1	774.0	>500	Pass
	39	2480	1131.2	779.0	>500	Pass

Note : The worst case of Occupied Bandwidth as below:



4.7 Fundamental emission output power	VERDICT: PASS
--	----------------------

4.7.1 Limit

Standard	FCC Part 15 Subpart C Paragraph 15.247 (b)(3)	
<input checked="" type="checkbox"/> GTX < 6dBi	Pout ≤ 30dBm	
<input type="checkbox"/> GTX > 6dBi		
<input type="checkbox"/> Non-Fix point-point	Pout ≤ 30 - (GTX - 6)	
<input type="checkbox"/> Fix point-point	Pout ≤ 30 - [(GTX - 6)]/3	
<input type="checkbox"/> Point-to-multipoint	Pout ≤ 30 - (GTX - 6)	
<input type="checkbox"/> Overlap Beams	Pout ≤ 30 - [(GTX - 6)]/3	
<input type="checkbox"/> Aggregate power transmitted simultaneously on all beams	Pout ≤ 30 - [(GTX - 6)]/3	
<input type="checkbox"/> single directional beam	Pout ≤ 30 - [(GTX - 6)]/3 + 8dB	

Note 1 : GTX directional gain of transmitting antennas.
 Note 2 : Pout is maximum peak conducted output power .

4.7.2 Test Setup

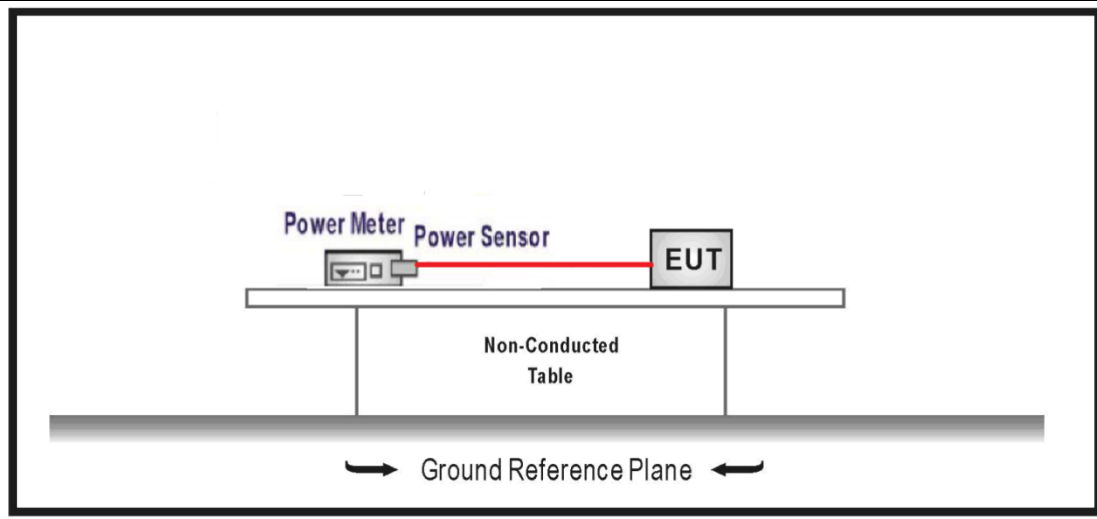

4.7.3 Test Procedure				
	References Rule		Chapter	Description
<input checked="" type="checkbox"/>	ANSI C63.10		11.9	Fundamental emission output power
	<input checked="" type="checkbox"/>	ANSI C63.10	11.9.1	Maximum peak conducted output power
	<input type="checkbox"/>	ANSI C63.10	11.9.1.1	RBW \geq DTS bandwidth
	<input type="checkbox"/>	ANSI C63.10	11.9.1.2	Integrated band power method
	<input type="checkbox"/>	ANSI C63.10	11.9.1.3	PKPM1 Peak power meter method
	<input type="checkbox"/>	ANSI C63.10	11.9.2	Maximum conducted (average) output power
	<input type="checkbox"/>	ANSI C63.10	11.9.2.2	Measurement using a spectrum analyzer (SA)
	<input type="checkbox"/>	ANSI C63.10	11.9.2.2.2	Method AVGSA-1(Duty cycle \geq 98%)
	<input type="checkbox"/>	ANSI C63.10	11.9.2.2.3	Method AVGSA-1A(Duty cycle \geq 98%)
	<input type="checkbox"/>	ANSI C63.10	11.9.2.2.4	Method AVGSA-2(Duty cycle \leq 98%)
	<input type="checkbox"/>	ANSI C63.10	11.9.2.2.5	Method AVGSA-2A(Duty cycle \leq 98%)
	<input type="checkbox"/>	ANSI C63.10	11.9.2.2.4	Method AVGSA-3
	<input type="checkbox"/>	ANSI C63.10	11.9.2.2.5	Method AVGSA-3A
	<input checked="" type="checkbox"/>	ANSI C63.10	11.9.2.3	Measurement using a power meter (PM)
	<input checked="" type="checkbox"/>	ANSI C63.10	11.9.2.3.1	Method AVGPM
<input type="checkbox"/>	ANSI C63.10	11.9.2.3.2	Method AVGPM-G	

4.7.4		Test Data					
Mode	Channel	Test Frequency (MHz)	Power Output (dBm)	EIRP Power Output (dBm)	Limit (dBm)	EIRP Limit (dBm)	Result
Mode 1	00	2402	9.49	11.57	≤30	≤36	Pass
	19	2440	9.19	11.27	≤30	≤36	Pass
	39	2480	9.29	11.37	≤30	≤36	Pass
Mode 2	00	2402	9.61	11.69	≤30	≤36	Pass
	19	2440	9.31	11.39	≤30	≤36	Pass
	39	2480	9.42	11.50	≤30	≤36	Pass
Mode 3	00	2402	9.52	11.60	≤30	≤36	Pass
	19	2440	9.22	11.30	≤30	≤36	Pass
	39	2480	9.31	11.39	≤30	≤36	Pass
Mode 4	00	2402	9.50	11.58	≤30	≤36	Pass
	19	2440	9.24	11.32	≤30	≤36	Pass
	39	2480	9.33	11.41	≤30	≤36	Pass

4.8 Power Density	VERDICT: PASS
--------------------------	----------------------

4.8.1 Limit:	
Standard	FCC Part 15 Subpart C Paragraph 15.247 (b)(3)
Power Spectral Density \leq 8dBm/3kHz	

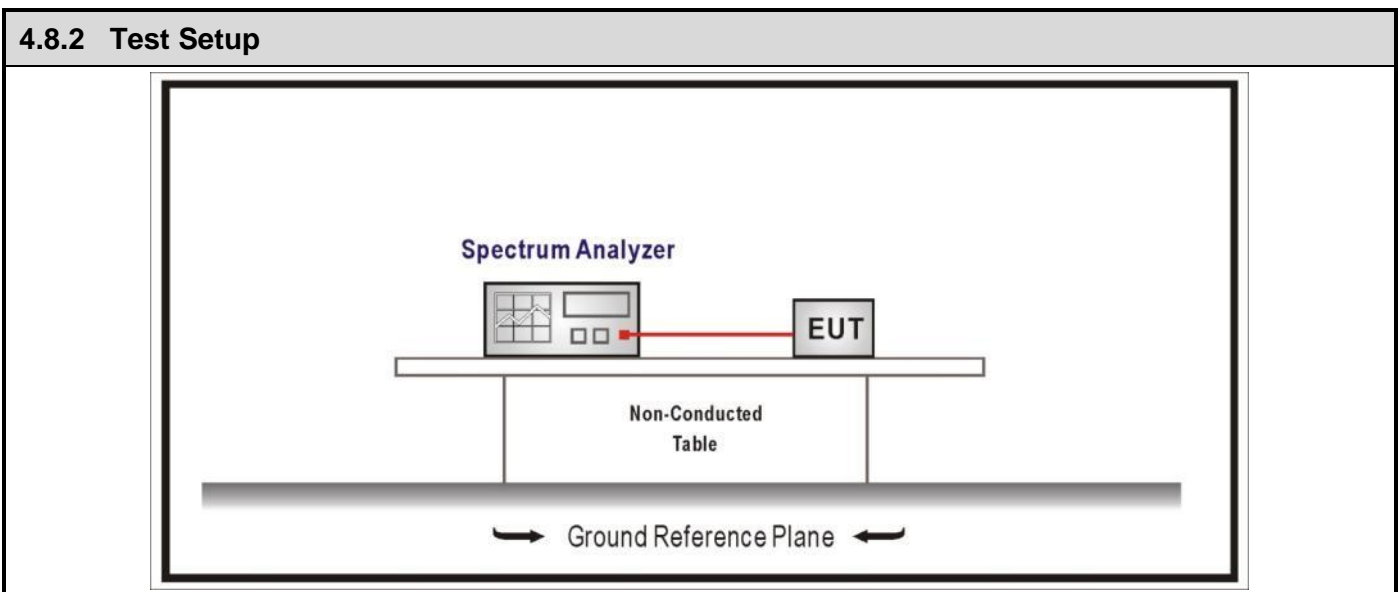

4.8.3 Test Procedure			
	References Rule	Chapter	Description
<input checked="" type="checkbox"/>	ANSI C63.10	11.10	Maximum power spectral density level in the fundamental emission
<input checked="" type="checkbox"/>	ANSI C63.10	11.10.2	Method PKPSD (peak PSD)
<input type="checkbox"/>	ANSI C63.10	11.10.3	Method AVGPSD-1(Duty cycle \geq 98%)
<input type="checkbox"/>	ANSI C63.10	11.10.4	Method AVGPSD-1A(Duty cycle \geq 98%)
<input type="checkbox"/>	ANSI C63.10	11.10.5	Method AVGPSD-2(Duty cycle $<$ 98%)
<input type="checkbox"/>	ANSI C63.10	11.10.6	Method AVGPSD-2A(Duty cycle $<$ 98%)
<input type="checkbox"/>	ANSI C63.10	11.10.7	Method AVGPSD-3
<input type="checkbox"/>	ANSI C63.10	11.10.8	Method AVGPSD-3A

4.9 Antenna Requirement	VERDICT: PASS
--------------------------------	----------------------

4.9.1 Limit:

Standard	FCC Part 15 Subpart C Paragraph 15.203
-----------------	--

An intentional radiator shall be designed to ensure that no antenna other than that furnished by the responsible party shall be used with the device. The use of a permanently attached antenna or of an antenna that uses a unique coupling to the intentional radiator shall be considered sufficient to comply with the provisions of this section. The manufacturer may design the unit so that a broken antenna can be replaced by the user, but the use of a standard antenna jack or electrical connector is prohibited. This requirement does not apply to carrier current devices or to devices operated under the provisions of §15.211, §15.213, §15.217, §15.219, or §15.221. Further, this requirement does not apply to intentional radiators that must be professionally installed, such as perimeter protection systems and some field disturbance sensors, or to other intentional radiators which, in accordance with §15.31(d), must be measured at the installation site. However, the installer shall be responsible for ensuring that the proper antenna is employed so that the limits in this part are not exceeded.

4.9.2 Antenna Connector Construction:

<input checked="" type="checkbox"/>	The use of a permanently attached antenna
<input type="checkbox"/>	The antenna use of a unique coupling to the intentional radiator
<input type="checkbox"/>	The use of a nonstandard antenna jack or electrical connector

Please refer to the attached document "Internal Photograph" to show the antenna connector.

5 TEST SETUP PHOTO AND EUT PHOTO

Remark: The test setup photo and EUT Photo please see appendix.

_____ The End _____