



Prüfbericht-Nr.: <i>Test Report No.:</i>	CN25ZTVA 001	Auftrags-Nr.: <i>Order No.:</i>	326115030	Seite 1 von 20 <i>age 1 of 20</i>
Kunden-Referenz-Nr.: <i>Client Reference No.:</i>	N/A	Auftragsdatum: <i>Order date:</i>	17.06.2025	
Auftraggeber: <i>Client:</i>	Shanghai Sonlu Shangling Enterprise Group Co.,Ltd. No.999 Zhongqiang Road, Maogang Industry park, Maogang Town, Songjiang City, Shanghai China			
Prüfgegenstand: <i>Test item:</i>	Refrigerator - Freezer			
Bezeichnung / Typ-Nr.: <i>Identification / Type No.:</i>	CD-140F-M, CD-140F-G			
Auftrags-Inhalt: <i>Order content:</i>	Type examination			
Prüfgrundlage: <i>Test specification:</i>	Resolution 438/2024, IEC 62552:2007 IRAM 2404-2:2000 IRAM 2404-3:2015+M1:2016			
Wareneingangsdatum: <i>Date of receipt:</i>	02.05.2025			
Prüfmuster-Nr.: <i>Test sample No.:</i>	Pre-production sample			
Prüfzeitraum: <i>Testing period:</i>	23.04.2025– 22.06.2025			
Ort der Prüfung: <i>Place of testing:</i>	See "Testing location"			
Prüflaboratorium: <i>Testing laboratory:</i>	TÜV Rheinland (Shanghai) Co., Ltd.			
Prüfergebnis*: <i>Test result*:</i>	Pass			
geprüft von: <i>tested by:</i>	<u>Jolin Ge</u>			
Datum: <i>Date:</i>	10.07.2025	Ausstellungsdatum: <i>Issue date:</i>	10.07.2025	
Stellung / Position:	PE	Stellung / Position:	Authorizer	
Sonstiges / Other:	N/A			
Zustand des Prüfgegenstandes bei Anlieferung: <i>Condition of the test item at delivery:</i>	Prüfmuster vollständig und unbeschädigt <i>Test item complete and undamaged</i>			
<p>* Legende: P(ass) = entspricht o.g. Prüfgrundlage(n) F(ail) = entspricht nicht o.g. Prüfgrundlage(n) N/A = nicht anwendbar N/T = nicht getestet * Legend: P(ass) = passed a.m. test specification(s) F(ail) = failed a.m. test specification(s) N/A = not applicable N/T = not tested</p> <p>Dieser Prüfbericht bezieht sich nur auf das o.g. Prüfmuster und darf ohne Genehmigung der Prüfstelle nicht auszugsweise vervielfältigt werden. Dieser Bericht berechtigt nicht zur Verwendung eines Prüfzeichens. <i>This test report only relates to the above mentioned test sample as. Without permission of the test center this test report is not permitted to be duplicated in extracts. This test report does not entitle to carry any test mark..</i></p>				

TEST REPORT IRAM 2404-3 Energy efficiency labelling of household refrigerating appliances		
Report Number	CN25ZTVA 001	
Date of issue	See cover page	
Total number of pages	See cover page	
Testing Laboratory	TÜV Rheinland (Shanghai) Co., Ltd.	
Address	Workshop 16, Pingqian (Taicang) Modern Industrial Park, No.525, Yuewang Lingang South Road, Shaxi Town, Taicang City, Jiangsu Province, China.	
Applicant's name	Shanghai Sonlu Shangling Enterprise Group Co.,Ltd.	
Address	No.999 Zhongqiang Road, Maogang Industry park, Maogang Town, Songjiang City, Shanghai China	
Manufacturer's name	Shanghai Sonlu Shangling Enterprise Group Co.,Ltd.	
Address	No.999 Zhongqiang Road, Maogang Industry park, Maogang Town, Songjiang City, Shanghai China	
Test specification:		
Standard.....	IEC 62552:2007 IRAM 2404-2:2000 IRAM 2404-3:2015+M1:2016	
Test procedure	Argentinean Energy Efficiency and Noise	
Non-standard test method.....	N/A	
Test item description	Refrigerator - Freezer	
Trade Mark	 	
Model/Type reference	CD-140F-M, CD-140F-G	
Ratings	220-240V, 50Hz, R600a	
Testing procedure and testing location:		
Testing Laboratory:	See cover page	
Testing location/ address	See cover page	
Tested by (name + signature)	See cover page	
Reviewed by (name + signature).....	See cover page	
Witnessed by (name + signature).....	See cover page	

List of Attachments (including a total number of pages in each attachment):

N/A

Summary of testing:

1. The appliance was tested according to IEC 62552:2007 and IRAM 2404-3:2015+M1:2016.

2. The tests were performed at voltage 220V, 50Hz.

3. Storage temperature test was conducted at 10°C and 43°C according to climate class ST/T. Energy consumption test, temperature rise test and freezing capacity test was conducted at 25°C according to IRAM 2404-3:2015+M1:2016.

4. The tests were performed on the model CD-140F-M.

5. Volume test, storage temperature test, energy consumption test, temperature rise test and freezing capacity test were conducted.

6. Noise test was at $22 \pm 3^\circ\text{C}$, 30% - 85%RH according to IRAM 2404-2:2000.

Testing location:**TÜV Rheinland (Shanghai) Co., Ltd.**





Workshop 16, Pingqian (Taicang) Modern Industrial Park, No.525, Yuewang Lingang South Road, Shaxi, Taicang, Jiangsu, China

Testing Results Summary:

Model designation	CD-140F-M
Measured storage volume (L)	123.4
Tested energy consumption (kWh/24h)	0.389
Temperature rise time (h)	7.95
Freezing capacity (kg/24h)	2.0
Energy Efficiency Class	B
Noise (dB(A))	38.5

Copy of marking plate (CD-140F-M)

- The artwork below may be only a draft.

Voltaje nominal(V)	220-240V	 <p>SONLU</p> <p>Frigorífico-congelador CD-140F-a</p> 
Frecuencia nominal(Hz)	50	
Clasificación de Protección Contra descargas Electricas	I	
Clase climática	ST/T	
Corriente nominal(A)	0.5	
Refrigerante, Carga(g)	R600a,35g	
Volumen Total(L)	123	
Volumen de almacenamiento del compartimento de alimentos frescos (L)	91	
Volumen Neto del Congelador(L)	32	
Consumo de Energía(kWh/año)	148	
Agente espumante	Ciclopentano	
Capacidad de congelación	2kg/24h	
Valor de aumento de temperatura	7h	
HECHO EN CHINA		
Fabricado Por: Shanghai Sonlu Shangling Enterprise Group Co.,Ltd		
No.999 Zhongqiang Road, Maogang Industry park, Maogang Town, Songjiang City, Shanghai China		
Voltaje nominal(V)	220-240V	 <p>SHANGLING</p> <p>Frigorífico-congelador CD-140F-a</p> 
Frecuencia nominal(Hz)	50	
Clasificación de Protección Contra descargas Electricas	I	
Clase climática	ST/T	
Corriente nominal(A)	0.5	
Refrigerante, Carga(g)	R600a,35g	
Volumen Total(L)	123	
Volumen de almacenamiento del compartimento de alimentos frescos (L)	91	
Volumen Neto del Congelador(L)	32	
Consumo de Energía(kWh/año)	148	
Agente espumante	Ciclopentano	
Capacidad de congelación	2kg/24h	
Valor de aumento de temperatura	7h	
HECHO EN CHINA		
Fabricado Por: Shanghai Sonlu Shangling Enterprise Group Co.,Ltd		
No.999 Zhongqiang Road, Maogang Industry park, Maogang Town, Songjiang City, Shanghai China		

Remark: a=M, G.

Copy of energy label

N/A

Possible test case verdicts:

- test case does not apply to the test object.....: N/A (or N)
- test object does meet the requirement.....: P (Pass)
- test object does not meet the requirement.....: F (Fail)

Testing

Date of receipt of test item: See cover page

Date(s) of performance of tests: See cover page

General remarks:

The test results presented in this report relate only to the object tested.
This report shall not be reproduced, except in full, without the written approval of the Issuing testing laboratory.

"(see Enclosure #)" refers to additional information appended to the report.

"(see appended table)" refers to a table appended to the report.

Throughout this report a comma / point is used as the decimal separator.

Name and address of factory:

Jiangsu Sonlu Electric Appliance Co.,Ltd.
No. 199 Tongda road of Economic Developing Dis
SuQian city, Jiangsu P.R. China

General product information:

- The appliance are type I upright refrigerator - freezer belong to category 7 according to Table 2 of IRAM 2404-3:2015+M1:2016.;
- The appliance is a manual defrost refrigerator - freezer. The compressor was supplied through a fixed-frequency.
- The rated storage volume is 91L for fresh food storage compartment, 32L for 4-star freezer compartment. The refrigerant is R600a.
- The rated freezing capacity is 2kg/24h.
- CD-140F-G is same as CD-140F-M, except for doors material. 'M' means steel door and 'G' means glass door.

Brand	Model
SHANGLING	CD-140F-M, CD-140F-G
SONLU	CD-140F-M, CD-140F-G
N/A	N/A

Sample information :



Model	CD-140F-M
Rate voltage	220 -240V, 50Hz
Compressor	MX1080Y
Climate type	ST/T
Condenser fan motor	N/A
Thermostat	Thermostat
Defrost power input	N/A
Lamp power	N/A



Clause	Requirement + Test	Result - Remark	Verdict
4	REQUIREMENTS		P
4.1	The label must be legible and must be stuck or placed on the external front part of the appliance, so that it is clearly visible and not hidden.		P
5	ENERGY EFFICIENCY CLASSES		P
5.1	Calculation of the equivalent volume	see Appendix A	P
5.2	Calculation of the energy efficiency index	see Appendix A	P
5.2.1	The Energy Efficiency Index (EEI) %/Class	see Appendix A	P
5.2.2	The annual energy consumption (AE _c) calculated in kWh/year	see Appendix A	P
5.2.3	The standard annual energy consumption (SAE _c) is calculated in kWh/year	see Appendix A	P
6	LABEL		P
6.2	<p>The following information shall be included in the label:</p> <p>I) Product name or trademark;</p> <p>II) Supplier's model identifier;</p> <p>III) The energy efficiency class of the appliance determined in accordance with Chapter 5 and verified pursuant to a B.6. The arrowhead that has this indicating letter must be placed at the same height as the corresponding arrowhead;</p> <p>IV) Energy consumption in accordance with the test method specified in Chapter 15 of IEC 62552, calculated in kWh/year (i.e., 24 h x 365 days) and in accordance with Annex 5.2.2;</p> <p>V) Fresh food volume: sum of the storage volume of all compartments that do not merit a star rating (operating temperature higher than - 6 °C);</p> <p>VI) Volume of frozen food: sum of the storage volume of all frozen-food compartments that merit a star rating (operating temperature higher or equal to - 6 °C);</p> <p>VII) Star rating of the frozen-food compartment in accordance with Table 6 under 7.1 d). When a compartment does not merit a star rating, the space for symbols must be left blank;</p> <p>VIII) The noise level expressed in dB (A), referred to 1 pW and measured according to the provisions of Standard IRAM 2404-2;</p> <p>IX) Climate class In accordance with Table 5.</p>		P

Clause	Requirement + Test	Result - Remark	Verdict
7	TEST METHODS		P
7.2	For appliances classified according to Table 2 (frost-free or not) energy consumption should be measured according to the provisions in Standard IEC 62552 Chapter 15.		P
7.3	Characteristics associated to energy consumption <ul style="list-style-type: none"> a) Storage volume of the appliance b) The storage volume of any low temperature compartment or of any freezer compartment, together with the climate classification and the classification symbol and the storage volume of any cellar compartment and/or fresh-food compartment, if applicable; c) Indication of "frost-free" appliance when the provisions set forth in Standard IEC 32552, item 3.1.3.1 are met; d) Freezing capacity, if applicable; e) Temperature rise time, if applicable 		P
7.3.1	Storage volume/s should be measured according to the provisions set forth in Standard IEC 62552, Chapter 7.		P
7.3.2	The freezing capacity should be measured according to Standard IEC 62552, Chapter 17.		P
7.3.3	The temperature rise time should be measured according to Standard IEC 62552, Chapter 16.		P
7.3.4	The storage temperature should be measured according to Standard IEC 62552, Chapter 13, with deviations set forth in item 7.1 of this standard		P
8	DATA SHEET (to be included in the user manual)		P
	The data sheet must include the following information: <ul style="list-style-type: none"> a) Supplier's name or trade mark; b) Supplier's model identifier; c) Category of the appliance, according to Table 2; d) Classification of the model according to its energy efficiency in accordance with Table 4, stated as Class of energy efficiency in a scale that ranges from A (most efficient) to G (least efficient) If this information is provided in a chart, it can be stated in any other way provided it is clearly understood that the scale varies from A (most efficient) to G (least efficient); 		P

Clause	Requirement + Test	Result - Remark	Verdict
	<p>e) Energy consumption according to the test procedures mentioned on Chapter 7 of this standard, calculated in kWh per year (5.2.2). The following statement should be added: “El consumo de energía real depende de las condiciones de uso del aparato y de su localización”; (Actual Energy consumption will depend on how the appliance is used and where it is placed.)</p> <p>f) Storage volume of each compartment that do not merit a star with operating temperature higher than -6°C.</p> <p>g) Storage volume of each compartment of frozen-food storage that merit a star rating. (Operating temperature less or equal to -6°C.)</p> <p>h) Star classification of the frozen-food compartment, if any;</p> <p>i) the legend “Sin escarcha” (frost-free), may be included here, when applicable, pursuant to the test procedures mentioned in standard IEC 62552;</p> <p>j) Autonomia deh (Autonomy of h) is the period of temperature rise according to the test procedures mentioned in Chapter 7 of this Standard;</p> <p>k) The freezing capacity in kilograms per 24 h is verified according to Chapter 7 herein;</p> <p>l) Climate class as provided in Chapter 7 herein;</p> <p>m) Noise level expressed in dB (A) referred to 1 pW and measured according to IRAM 2404-2 Standard</p>		

TABLE: List of critical components					P
Object/part No.	Manufacturer/ trademark	Type/model	Technical data	Standard (Edition / year)	Mark(s) of conformity ¹⁾
Motor compressor	JIAXIPERA COMPRESSOR Co., Ltd.	MX1080Y	220-240V 50Hz R600a	IEC 60335-1 IEC 60335-2-34	CVC0012025 -0243 Tested with appliance
Thermostat	Changzhou Thermoster Electrical Appliance Co., Ltd.	WD***-L* WD*E**-L* WP***-L* WP*E**-L*	AC 250V, 6 (4)A; 20E4, PTI 250, T70	IEC 60730-1 IEC 60730-2-9 IEC 60079-15	VDE 40024527 CNEX CNEx17.443 6X
Alternative	Changzhou Huishang Electric Co., Ltd.	Wtuvxy-Lz	AC 250V, 6(4)A; 10E4, PTI 250, T70	IEC 60730-1 IEC 60730-2-9 IEC 60079-15	TUV R 50284386 TUV R AK 50365587 0001
Alternative	Yuyao Mingtong Electric appliance Co., Ltd.	W-L series	AC 250V, 5(4)A, IE5, PTI 250, T55	IEC 60730-2-9 IEC 60730-1 IEC 60079-15	CB CN5918 CL 50671000 0001
Alternative	Changzhou Huishang Electrical Co., Ltd.	WD/WP Series	250VAC,6(4)A, 125VAC,8(6)A, 50/60Hz,Operating -40°C~55°C, IE5	IEC 60730-2-9 IEC 60730-1 IEC 60079-15	CB. CN39323 TUV R AK 50365587 0001
LED module	Changzhou Hengye Electrical Appliances Co., Ltd.	HY series	AC220-240V	IEC 62471 IEC 60335-1 IEC 60335-2-24	EED310818 Tested with appliance
LED module	Yuyao Fengzhe Electrical Appliance Factory	YYFZ series	AC220-240V	IEC 62471 IEC 60335-1 IEC 60335-2-24	TUV CN22QN800 01 Tested with appliance
LED module	Yuyao Fengzhe Electrical Appliance Factory	FZ-SL series	AC220-240V	IEC 62471 IEC 60335-1 IEC 60335-2-24	TUV CN22QN800 01 Tested with appliance
Supplementary information:					

Test 1.		Storage temperature test		P	
Test Conditions					
Appliance control settings:		Thermostat setting		Thermostat setting	
					
Ambient Temperature		18.0°C		43.0°C	
Power Supply:		220V/50Hz		220V/50Hz	
Other Test Conditions		According to clause 7 of the standard IRAM 2404-3:2015+M1:2016 and clause 8 of the standard IEC 62552:2007.			
Test Results					
		Measuring 1	Measuring 2	Requirement	Verdict
Ambient Temperature		18.0°C	43.0°C	--	--
Fresh food storage compartment temperature	t _{1m} (°C)	2.85	4.32	0≤t _{1m} , t _{2m} , t _{3m} ≤8	P
	t _{2m} (°C)	3.22	3.87	0≤t _{1m} , t _{2m} , t _{3m} ≤8	P
	t _{3m} (°C)	2.56	1.54	0≤t _{1m} , t _{2m} , t _{3m} ≤8	P
	t _{ma} (°C)	2.88	3.24	≤+4	P
Chill compartment temperature	t _{cc,min} (°C)	N/A	N/A	-2≤t _{cc} ≤3	N/A
	t _{cc,max} (°C)	N/A	N/A	-2≤t _{cc} ≤3	N/A
Frozen food storage or food freezer compartment, cabinet or section highest temp. (°C)	t ^{***} (°C)	-19.64	-21.11	≤-18	P
	t ^{**} (°C)	N/A	N/A	≤-12	N/A
	t [*] (°C)	N/A	N/A	≤-6	N/A
The highest maximum temperature of 4-star compartment/section during defrost cycle(°C)		N/A	N/A	≤-15	N/A
The duration of defrosting period (minutes)		N/A	N/A	Period of 20% of the operating cycle of max. 4h	N/A
The duration of operating cycle (minutes)		1440	1440	--	--
Remark: The temperature sensor in fresh food compartment and loading plan for freezer compartment can refer to Appendix B.					

Test 2.		Energy consumption test			P
Test Conditions					
Ambient Temperature:		25°C			
Power Supply:		220V/50Hz			
Other Test Conditions		According to clause 7 of the standard IRAM 2404-3:2015+M1:2016 and clause 8 of the standard IEC 62552:2007.			
Test Results					
Appliance control settings:		Thermostat setting	Thermostat setting	-	
					
		Measuring 1	Measuring 2	interpolated	
Fresh Food Storage Compartment Temperature	t _{1m} (°C)	3.64	5.12	-	
	t _{2m} (°C)	3.91	5.44	-	
	t _{3m} (°C)	2.92	4.57	-	
	t _{ma} (°C)	3.49	5.04	5.0	
Chill compartment temperature	t _{cc,min} (°C)	N/A	N/A	-2 ≤ t _{cc} ≤ 3	
	t _{cc,max} (°C)	N/A	N/A	-2 ≤ t _{cc} ≤ 3	
The maximum temperature of the warmest M-package in the two star section(°C)	t** (°C)	N/A	N/A	-12.0	
The maximum temperature of the warmest M-package in the food freezer compartment (°C)	t*** (°C)	-20.13	-19.10	-18.0	
Mean Ambient Temperature(°C)		25.0	25.0	25.0	
The energy consumption result kWh / 24h		0.432	0.388	0.389	
Test period of operating cycle (minutes)		1440	1440	-	
Remark:					
1) The calculated value is less than rated value, which is within the range defined in ANNEX E of IEC 62552:2007.					
2) The loading plan for freezer compartment is identical with storage temperature test.					

Test 3.		Freezing capacity test		P	
Test Conditions					
Ambient Temperature:		25°C			
Power Supply:		220V/50Hz			
Appliance control settings:					
ballast load (kg):		13.0			
light load (kg):		2.0			
Other Test Conditions		According to clause 7 of the standard IRAM 2404-3:2015+M1:2016 and clause 8 of the standard IEC 62552:2007.			
Test Results					
Item			Requirement	Verdict	
Food freezer Compartment	ballast load temperature	t*** max (°C) during test	-15.2	≤-15	P
		t*** max (°C) upon completion of test	-21.1	≤-18	P
	light load temperature	Arithmetic mean temperature of light load	-18.0	≤-18	P
Two star section	light load temperature	Warmest temperature of t** (°C)	N/A	≤-9	N/A
	light load temperature	Warmest temperature of t** end of the test (°C)	N/A	≤-12	N/A
Fresh Food Storage Compartment	t1 (°C) range	0.1~3.5		0≤t1≤+10	P
	t2 (°C) range	0~3.8		0≤t2≤+10	P
	t3 (°C) range	0~3.6		0≤t3≤+10	P
	ta (°C) range	0~3.6		≤+7	P
Freezing time (hours)		12.9		≤24	P
Freezing Capacity ¹⁾ (kg)		2.0		2.0	P ²⁾
Remark: 1) The freezing time is below 22h, according to client requirement, the freezing capacity is only declared as 2.0kg. 2) The calculated freezing capacity is greater than rated freezing capacity by 0%, which is within the range defined in ANNEX V, table 1. 3) Loading plan for freezer compartment can refer to page Appendix B.					

Test 4.	Temperature rise test	P
Test Conditions		
Ambient Temperature:	25°C	
Other Test Conditions	According to clause 7 of the standard IRAM 2404-3:2015+M1:2016 and clause 8 of the standard IEC 62552:2007.	
Test Results		
Temperature rise time (h)	7.95	
Remark: Loading plan for freezer compartment can refer to page Appendix B.		

Test 5.	Noise test	P			
Test Conditions					
Ambient Temperature and humidity	22 ± 3°C, 30% - 85%RH				
Atmospheric pressure	96 ± 10kPa				
Test voltage/frequency	220V /50Hz				
Measurement surface	parallelepiped				
Measurement distance	d=1m				
Test Results					
Microphone No.	Sound pressure level			Background noise level	Judgment
	1st Time	2nd Time	3rd Time		
L_{p1} /dB(A)	26.02	25.45	25.72	13.0	—
L_{p2} /dB(A)	29.23	28.55	28.92	13.0	—
L_{p3} /dB(A)	28.78	27.99	28.81	13.0	—
L_{p4} /dB(A)	22.74	22.39	22.80	13.0	—
L_{p5} /dB(A)	24.77	23.80	24.75	13.0	—
L_{p6} /dB(A)	26.27	25.36	26.00	13.0	—
Averaged sound pressure level L_{pm} /dB(A)	26.85	26.12	26.69	13.0	—
Background noise correction K_1 /dB(A)	—	—	—	—	—
Environmental correction K_2 /dB(A)	—	—	—	—	—
Sound power level L_W /dB(A)	38.80	38.07	38.64	—	—
Averaged sound power level L_W /dB(A)	38.5			—	39
Remark: measurement surface figure of noise test can refer to Appendix C.					
Notes: The test was subcontracted to the below laboratory: Name: TUV Rheinland (Shanghai) Co., Ltd. Address: Workshop 16, Pingqian (Taicang) Modern Industrial Park, No.525, Yuewang Lingang South Road, Shaxi, Taicang, Jiangsu, China					

Appendix A - Details of volume and energy efficiency grade calculations**Volume calculation:**

	Storage Volume (Litres)	
	Rated	Measured
Fresh food compartment (limit: $\geq 97\%$ or -1l)	91	91.0
2-star section (limit: $\geq 97\%$ or -1l)	N/A	N/A
4-star food freezer compartment (limit: $\geq 97\%$ or -1l)	32	32.4
TOTAL	123	123.4
Deviation (limit: $\geq 97\%$)	100.3%	
Remark: the deviation for total storage volume, comply with the standard requirement.		

**Calculation of Energy Efficiency Index according to IRAM 2404-3:2015+M1:2016:
(Based on Rated Value)**

Category	7		
Compartment	Fresh food storage compartment	Food freezer compartment	2-star compartment
Effective volume (L)	91	32	N/A
Design temperature(°C)	4	-18	-12
Thermodynamic factor	1	2.15	1.85
Total equivalent volume (L)	192		
FF _c	1.0	1.0	1.0
CC	1.2		
BI	1.0		
M	0.777		
N	303		
CH	0		
Standard annual energy consumption (SAEc/ kWh/year)	452.18		
Rated annual energy consumption (AEc/ kWh/year)	148		
EEI	32.7		
Energy efficiency class according to IRAM 2404-3:2015+M1:2016, clause 5, Table 4	B ($22 \leq EEI < 33$)		

**Calculation of Energy Efficiency Index according to IRAM 2404-3:2015+M1:2016:
(Based on Measured Value)**

Category	7		
Compartment	Fresh food storage compartment	Food freezer compartment	2-star compartment
Effective volume (L)	91.0	32.4	N/A
Design temperature(°C)	5	-18	-12
Thermodynamic factor	1	2.15	1.85
Total equivalent volume (L)	193		
Energy consumption result (kWh/24h)	0.389		
FF _c	1.0	1.0	1.0
CC	1.2		
BI	1.0		
M	0.777		
N	303		
CH	0		
Standard annual energy consumption (SAEc/ kWh/year)	452.96		
Rated annual energy consumption (AEc/ kWh/year)	142		
EEI	31.3		
Energy efficiency class according to IRAM 2404-3:2015+M1:2016, clause 5, Table 4	B ($22 \leq EEI < 33$)		

Clase de eficiencia energética (IRAM 2404-3:2015)	Índice de eficiencia energética [IEE]	Clase de eficiencia energética actualizada
A+++	IEE < 22	A
A++	$22 \leq IEE < 33$	B
A+	$33 \leq IEE < 42$	C
A	$42 \leq IEE < 55$	D
B	$55 \leq IEE < 75$	E
C	$75 \leq IEE < 90$	F
D	$90 \leq IEE$	G

Appendix B - Charge of test packages. Charging plan and Location of temperature sensors
Temperature measurement points in fresh-food storage compartment:

N/A

Loading plan for inside freezer compartment for energy consumption, storage temperature, temperature rise (Red packages are M packages):

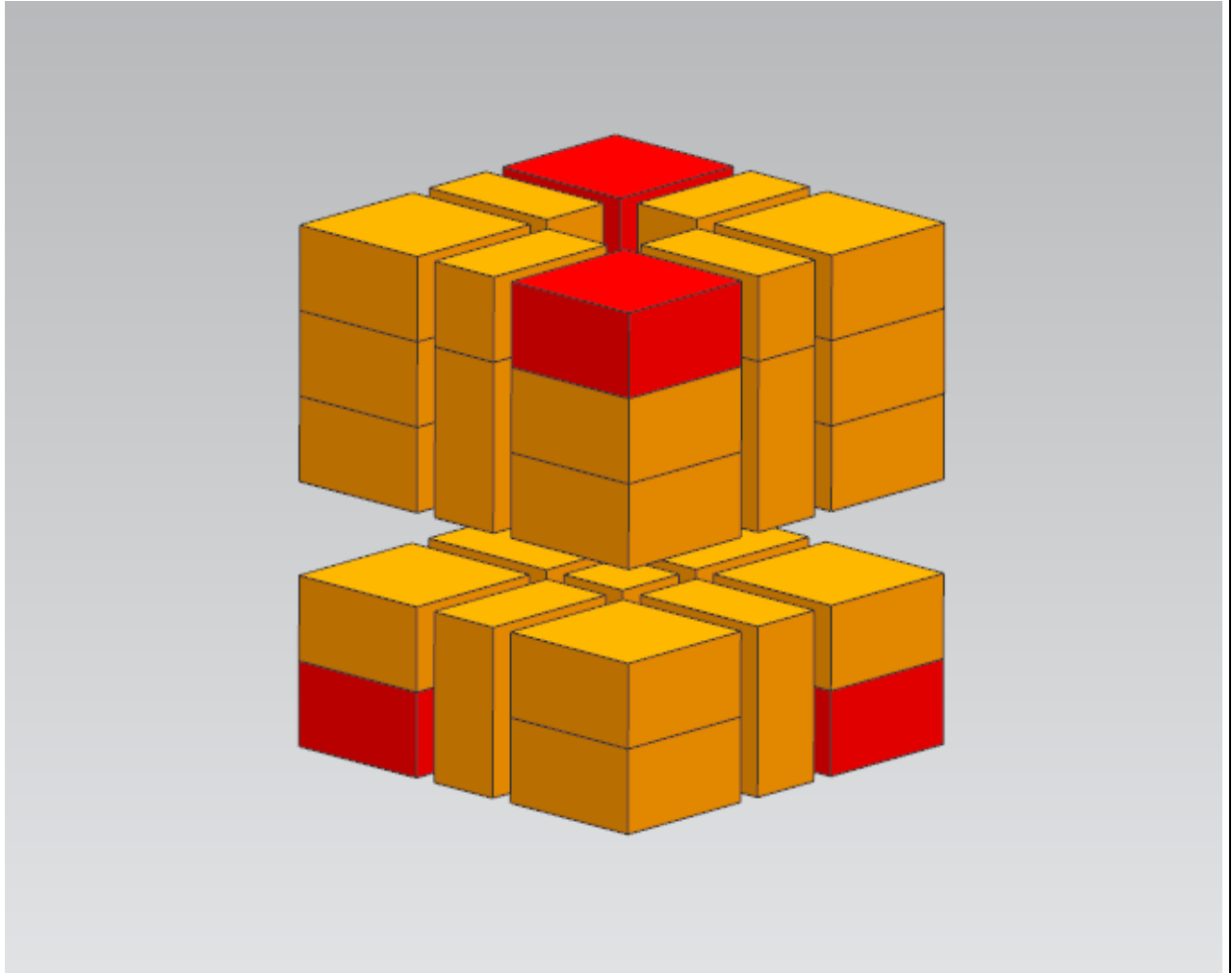

Package code	Size(mm)	Weight(g)	Unit
For freezer compartment: 15.5kg			
Test packages	200X100X50	1000	0
Test packages	100X100X50	500	24
Test packages	100X50X50	250	6
M Packages	100X100X50	500	4

Freezing capacity loading plan for inside freezer compartment:

Red packages are M packages of ballast load. Orange packages are test packages of ballast load. The blue packages at the bottom are M packages of light load. Red packages on the blue packages are test packages of light load.

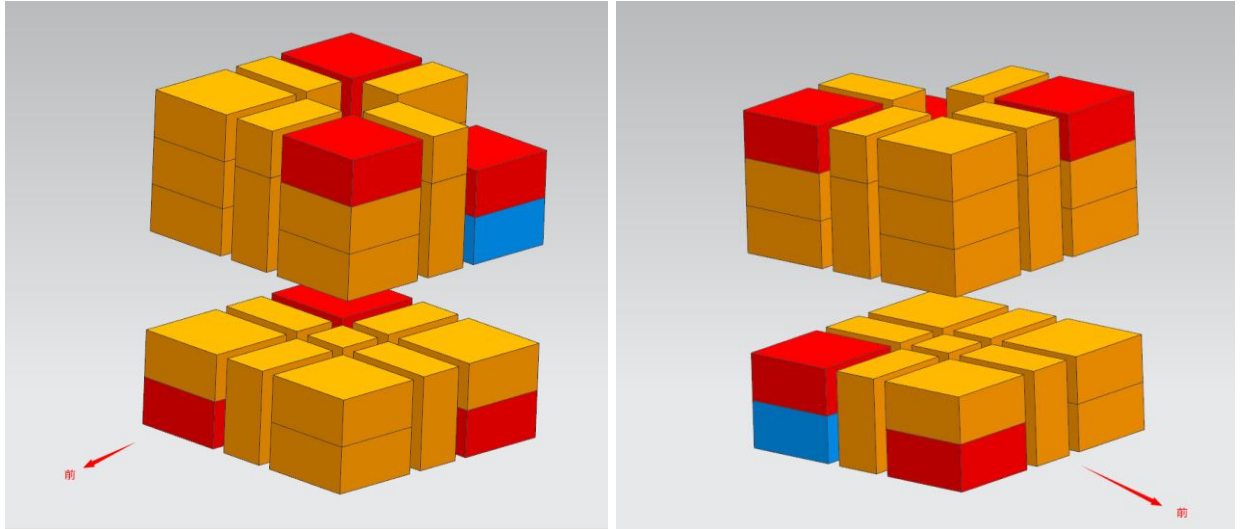

Ballast load

Package code	Size(mm)	Weight(g)	Unit
For freezer compartment: 13kg			
Test packages	200X100X50	1000	0
Test packages	100X100X50	500	19
Test packages	100X50X50	250	6
M Packages	100X100X50	500	4

Light load (Total: 2.00kg)

Package code	Size(mm)	Weight(g)	Unit
Test packages	200X100X50	1000	0
Test packages	100X100X50	500	2
M Package	100X100X50	500	2

Appendix C - Noise test measurement surface figure

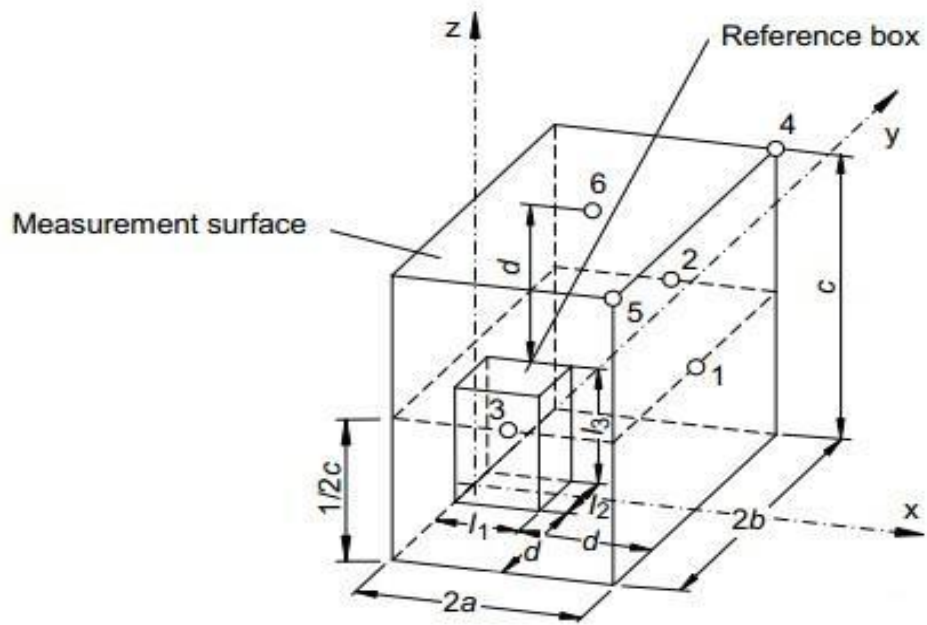

Appendix D - Photo documents for the appliance

Picture 1 Front view



Picture 2 Interior



Picture 3 Rear view



Picture 4 Compressor chamber, Picture 5 compressor



MX1080Y 220-240V~50Hz
JIA XIPETA COMPANY CO., LTD.
jia xipeta®
L

CCC
RoHS



Appendix E - Testing Equipment Lists

No.	Name of Equipment	Type No. & Series No.	Calibration Due Date YYYY.MM.DD
1	■ 6HP Enthalpy Lab 6HP 焓差室	9065925/Z671A	2025-07-09
2	■ Vernier Caliper 游标卡尺	G1812280	2025-10-14
3	■ Tape Ruler 钢卷尺	L810A	2027/12/5
4	■ Digital hygrometer thermometer 数显温湿度计	TES1161	2025-12-18
5	■ Digital Electrical Parameter Measuring Instrument 数显电参数测量仪	8716C	2025-10-15
6	■ Dynamic Signal Acquisition 动态信号采集仪	AHAI2022	2026-03-14
Test Lab	TUV Rheinland (Shanghai) Co., Ltd.		
Address	Workshop 16, Pingqian (Taicang) Modern Industrial Park, No.525, Yuewang Lingang South Road, Shaxi, Taicang, Jiangsu, China		

--End of report--